



SELECTION

2025

WORKBOOK 2025

SÉLECTION DES MEILLEURS COMPOSANTS
ET ACCESSOIRES POUR LE CYCLISME

Selle Royal

fi'zi:k

crankbrothers

Continental 

PEDALED

WORKBOOK 2025

SELLE ROYAL	5
FIZIK	43
CRANKBROTHERS	123
CONTINENTAL	189
PEDALED	235
OVERVIEW	237



Selle Royal





SELLE ROYAL

Product categories



All Journeys Riding Everywhere

Il top di gamma di Selle Royal: questi prodotti sono perfetti per coloro che non vogliono scendere a compromessi, tanto negli spostamenti urbani quanto nelle avventure fuoriporta. La gamma All Journeys combina materiali di prima qualità e tecnologie innovative per garantire comfort e durata ottimali, senza rinunciare ad un design accattivante.

Ces produits Selle Royal, les meilleurs de leur catégorie, sont adaptables et parfaits pour ceux qui ne veulent pas lésiner sur l'excellence, que ce soit en ville ou à l'extérieur. Avec la gamme All Journeys, les matériaux de première qualité et les technologies innovantes permettent d'obtenir le meilleur en matière de confort, de design et de durabilité.



Adventure Time Exploring Outdoors

Le compagne di viaggio per le tue escursioni. Pedali per divertirti, per fare sport o per andare lontano? Questa gamma di selle è studiata per il tuo tempo libero in bicicletta. Tutti i modelli sono adatti a lunghe uscite e a diversi tipi di terreno, per esplorare la natura a modo tuo.

Une bouffée d'air frais pour toutes les excursions. Que vous roulez pour le plaisir, pour la forme ou pour partir en excursion loin de chez vous, cette gamme de selles donne le meilleur d'elle-même pour vous aider à profiter de votre temps libre à vélo. Tous ces modèles sont adaptés aux longues sorties et à différents types de terrains, pour que vous puissiez explorer la nature à votre guise.



Urban Life Moving in the City

Comfort ottimale per pedalare in città. Modelli studiati per accompagnarti nella vita di tutti i giorni, nei brevi tragitti o nei lunghi spostamenti in bici nella giungla urbana. Lasciati sorprendere dalla comodità, dallo stile e dall'affidabilità.

Le confort ultime pour le vélo en ville. Toute selle appartenant à cette gamme deviendra votre alliée de confiance au quotidien. Qu'il s'agisse de courtes balades ou de longs trajets, d'un style moderne ou d'une grande fiabilité, choisissez parmi de nombreux modèles en fonction de vos besoins en ville.

Riding positions

La posizione di guida è il fattore cruciale nella scelta della sella. A seconda dello stile di guida varia, infatti, il modo in cui le ossa del bacino poggiano sulla sella, influenzando quindi il livello di comfort generale. I prodotti di Selle Royal sono progettati ergonomicamente per accogliere le diverse larghezze di ossa ischiatiche e soddisfare le esigenze anatomiche di donne e uomini, garantendo la riduzione della pressione nelle zone più sensibili.

Scegli la tua corretta posizione di guida tra **45° (Athletic)**, **60° (Moderate)** e **90° (Relaxed)** e goditi le tue uscite in bici senza pensieri!

La position de conduite est un facteur crucial dans le choix de la selle optimale. En fonction de votre manière de rouler, la façon dont vos ischions reposent sur la selle varie considérablement et cela affecte par conséquent le niveau de confort. Les selles Selle Royal sont conçues de manière ergonomique pour s'adapter à toutes les largeurs d'ischions et satisfaire les besoins anatomiques des hommes et des femmes, en garantissant un soulagement de la pression dans les zones les plus sensibles.

Choisissez votre position de conduite entre **45° (Athletic)**, **60° (Moderate)** et **90° (Relaxed)** pour profiter de vos sorties sans douleur!

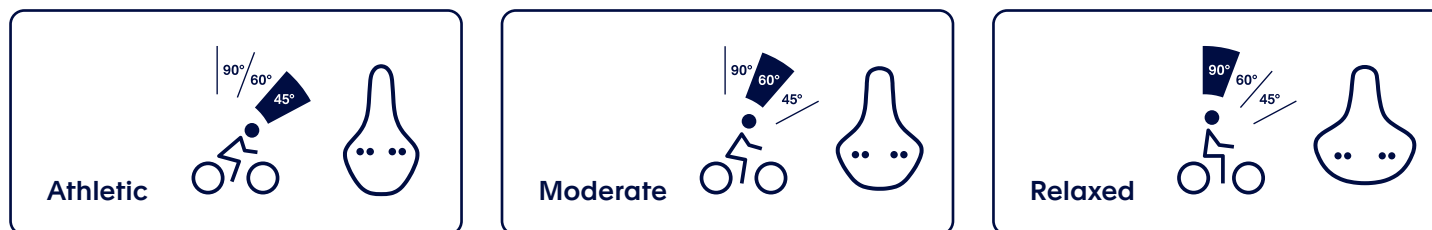

30 Day Comfort Guarantee

Selle Royal offre una Garanzia Comfort di 30 giorni su tutti i prodotti. Anche il nuovo packaging presenta uno specchietto sul fronte per informare i consumatori di questa opportunità: assicurati di assistere i tuoi clienti perché possano beneficiare di questo vantaggio!

Selle Royal offre une garantie de confort de 30 jours sur tous les produits. Le nouvel emballage affiche également clairement cette information sur le devant : assurez-vous d'informer correctement vos clients de cet avantage afin qu'ils puissent en profiter!

Product features

Royal Comfort



ROYALGEL™

Superiore a qualsiasi altra imbottitura grazie alla sua formulazione unica, Royalgel™ è studiato per garantire il massimo livello di comfort. Durevole e versatile, questa tecnologia assorbe la pressione e la distribuisce su tutta la superficie della sella, garantendo un supporto ottimale anche nelle pedalate più lunghe.

Supérieur à tout autre matériau de rembourrage, le Royalgel™ offre le plus haut niveau de confort grâce à sa formulation unique. Durable et polyvalente, cette technologie absorbe la pression et la répartit sur la surface de la selle pour offrir le meilleur soutien, même pour vos plus longues sorties.

Immediate Comfort



SLOW FIT FOAM

Ideale per brevi spostamenti, Slow Fit Foam è una tecnologia esclusiva di Selle Royal progettata per adattarsi alla forma del tuo corpo. La sua formulazione in memory foam a lento effetto di ritorno fornisce comfort ottimale e assicura una sensazione di morbidezza durante la pedalata.

Idéale pour les sorties courtes et faciles, la mousse Slow Fit Foam est une technologie exclusive de Selle Royal conçue pour épouser la forme de votre corps. Sa formulation en mousse à mémoire de forme, avec un effet de rebondissement lent, procure un confort immédiat et assure une sensation de douceur pendant la conduite.

Firm Comfort



FOAM MATRIX

Robusta, flessibile e adatta alle uscite di tutti i giorni: un'imbottitura in Foam Matrix è la scelta ideale se sei alla ricerca di un supporto stabile e solido per i tuoi viaggi brevi e meno impegnativi.

Robuste, mais flexible pour les trajets quotidiens. Si vous recherchez un soutien ferme et solide pendant vos trajets courts et faciles, une selle avec un rembourrage Foam Matrix est ce qu'il vous faut.

Extreme Durability



UNITECH

Dotate di un unico materiale per imbottitura e rivestimento, le selle con tecnologia Unitech sono progettate per durare a lungo. Grazie a impermeabilità e alta resistenza all'abrasione, non dovrete più preoccuparvi delle intemperie e delle sfide della giungla urbana.

Avec un rembourrage et un revêtement en une seule pièce, les selles dotées de la technologie Unitech sont conçues pour durer, car elles sont très résistantes à l'abrasion et imperméables. Vous n'aurez donc pas à vous soucier d'exposer votre selle aux éléments ou aux dangers de la ville.

Waterproofness



ROYAL VACUUM

Rimani all'asciutto durante le tue pedalate! Progettata per resistere all'acqua, questa tecnologia brevettata da Selle Royal permette alla sella di essere sigillata al 100% e quindi impermeabile, anche quando esposta a forti intemperie.

Profitez d'un trajet au sec avec une selle résistante à l'eau. Cette technologie brevetée Selle Royal permet à la selle d'être 100% étanche et substantiellement imperméable, même lorsqu'elle est exposée à un temps lourd et humide.

Fresh Seat



COOL COVER

Una speciale composizione del rivestimento della sella riflette la luce del sole ed assicura una temperatura di 25°C più fresca rispetto ad una sella nera standard. Potrai così lasciare la tua bici al sole senza pensarci due volte.

La composition spéciale de cette housse reflète la lumière du soleil et maintient votre selle à 25°C de moins qu'une selle noire standard. Vous pouvez donc laisser votre vélo au soleil sans y penser.

Perineal Ventilation



VENTILATION CHANNEL

Grazie a questa funzione di ventilazione non dovrete più temere il caldo durante i tuoi giri in bici: uno speciale canale anatomico consente all'aria di fluire attraverso la sella ed assicura una sensazione di freschezza mentre pedali, oltre ad una pressione ridotta nella zona perineale.

Ne laissez pas la surchauffe gâcher votre sortie : le canal de ventilation permet à l'air de circuler à travers votre selle grâce à une découpe anatomique, garantissant une sensation de brise et de non transpiration lorsque vous roulez. Conçu pour des sorties à la fraîche et réduire la pression dans la zone périnéale.

Perineal Relief



ERGONOMIC HOLE

Un foro centrale ergonomico progettato per alleviare la pressione nella zona perineale. Ideale anche per i ciclisti più sensibili: niente più fastidio durante le tue pedalate!

Une découpe centrale ergonomique conçue pour soulager la pression dans la zone périnéale, ce qui la rend idéale pour les cyclistes les plus sensibles. Pas de douleur, juste un avantage sur vos sorties!



ERGONOMIC CHANNEL

Un canale progettato per seguire ergonomicamente la forma del corpo, offrendo sollievo dalla pressione nella zona perineale e supporto nella zona ischiatica. Niente più dolore durante le tue uscite in bicicletta!

Cette échancrure est conçue pour épouser de manière ergonomique la forme du corps, en apportant un soulagement de la pression dans les zones de tissus sensibles et un soutien dans la zone ischiatique. Pas de douleur, juste un avantage sur vos sorties!

High Resistance



STRENGTEX

Un rivestimento ultra resistente, progettato per aumentare la durata della sella. Grazie alla sua struttura multistrato, la tua sella ricoperta in Strengetex resiste a forature, tagli, strappi, crepe o invecchiamento. Perfetta per la giungla urbana.

Il s'agit d'un matériau de revêtement ultra-résistant conçu pour accompagner ce que subit toute selle au cours de sa vie. Grâce à sa structure multicouche, votre revêtement Strengetex ne craint pas les perforations, les coupures, les déchirures, les fissures ou le vieillissement et rend donc votre selle parfaite pour la jungle urbaine.

Shock Absorption



FLEXITE SYSTEM

Uno scafo con esclusiva costruzione dentellata, per una flessibilità ottimizzata e assorbimento degli urti. L'ideale per pedalare in città e per gite nella natura, senza rinunciare al massimo del comfort.

La construction unique de la coque assure une flexibilité et une absorption des chocs maximales, garantissant des sorties en douceur en ville ou dans la nature.



THERMOPLASTIC DAMPER

Lavorando come un elastomero, questo ammortizzatore termoplastico posizionato nella parte posteriore della sella assorbe anche gli urti più forti ed assicura il massimo del comfort senza fare rumore.

Fonctionnant comme un élastomère, l'amortisseur thermoplastique placé à l'arrière de la selle adoucit les parcours cahoteux, en absorbant silencieusement les chocs les plus violents.



ELASTOMERS

Pedala prestando sempre attenzione agli ostacoli improvvisi. Ma se ne manchi uno, la tua sella con elastomeri assorbirà anche gli urti più forti, senza fare rumore.

Vous faites toujours attention aux obstacles inattendus, mais si vous en manquez un, votre selle avec élastomères absorbera les chocs les plus sévères sans faire de bruit.

Safe Sides



DOUBLE-COVER SIDE PROTECTION

Dimenticati dei lati della sella graffiati e appoggia la bici su qualsiasi superficie in totale libertà: il materiale a doppio strato applicato alle parti più esposte della sella aumenta la resistenza a urti e abrasioni.

Dites non aux flancs de selle éraflés et appuyez votre vélo contre n'importe quoi en toute liberté : le matériau double couche appliqué sur les flancs de la selle augmente la résistance aux impacts et aux abrasions.



SCUFF GUARDS

Dimenticati dei lati della sella graffiati e appoggia la bici su qualsiasi superficie in totale libertà: gli inserti extra protettivi applicati ai lati della sella aumentano la resistenza a urti e abrasioni.

Dites adieu aux flancs de selle éraflés et appuyez votre vélo sur n'importe quoi en toute liberté : les inserts de protection supplémentaires appliqués sur les flancs de la selle augmentent la résistance aux impacts et aux abrasions.

Safety at Night



REFLECTIVE FILM

Essere visibili alle altre macchine mentre si pedala è di fondamentale importanza, negli spostamenti urbani tanto quanto nelle avventure fuoripista. Questa pellicola riflettente aumenta la tua visibilità: l'ideale in condizioni di scarsa luminosità o se la tua luce posteriore dovesse scaricarsi.

Que vous roulez en ville ou que vous exploriez la nature, il est primordial de toujours être vu par les voitures, les vélos et les autres véhicules. Si, ou plutôt quand, votre feu arrière vous fait défaut, ce film réfléchissant protégera vos arrières pour une dose supplémentaire de sécurité.

Spring Suspension



DOUBLE SPRINGS

Le doppie molle garantiscono il massimo assorbimento degli urti e conferiscono alla sella un fascino classico. Per un look impeccabile senza rinunciare all'ammortizzazione che ti serve in città.

Un look saisissant et une excellente suspension, tout en un : les ressorts standard ont évolué pour améliorer les performances de la suspension tout en conservant leur allure classique, afin que vous n'ayez pas à faire de compromis sur le style - ou l'amortissement.



SPRINGS

Garantendoti l'ammortizzazione che ti serve in città, le molle aggiungono un tocco classico alla tua bici.

Parfois, c'était mieux avant : les ressorts ajoutent une excellente suspension et une touche de classe à n'importe quel vélo.

Clip & Go



INTEGRATED CLIP SYSTEM

Studiato per i tuoi accessori Selle Royal, l'Integrated Clip System è posizionato nella parte posteriore della sella per facilitare l'aggancio di una borsetta o di altri accessori Selle Royal. Il tutto in un solo clip.

Un must pour vos accessoires Selle Royal : le système de clip intégré positionné à l'arrière de votre selle permet de fixer une sacoche de selle Selle Royal ou d'autres accessoires d'un simple clip.



MULTI-TOOL

Niente più imprevisti durante le tue uscite in bici. Questo multi-tool si fissa alla clip posteriore della tua sella Selle Royal con Integrated Clip System, in modo da essere sempre a portata di mano per regolazioni e riparazioni mentre sei in giro. Protetto da una custodia in gomma antiurto, questo multi-tool compatto è composto da 9 attrezzi di qualità, per il massimo dell'affidabilità e della durevolezza.

Soyez toujours prêt à faire face aux imprévus. Ce multi-outil se fixe à l'arrière de votre selle Selle Royal équipée du système de clip intégré (ICS) afin d'être toujours à portée de main pour des réglages et des réparations rapides en cours de route. Protégé par un boîtier en caoutchouc antichoc, cet ensemble compact et sécurisé offre 9 outils pour des années d'utilisation fiable.

Support up to 150kg



HEAVY-DUTY SUPPORT

Testata fino a 150 kg, una sella affidabile e durevole che non teme pesi elevati.

Testée jusqu'à 150 kg, une selle fiable et durable qui ne craint pas les poids lourds.

E-Bike Specific



E-FIT DESIGN

Un design innovativo dalla forma curva ti aiuta a trovare facilmente la posizione corretta sulla tua e-bike. Allo stesso tempo la sezione posteriore rialzata della sella previene lo scivolamento all'indietro e garantisce il massimo comfort per la tua schiena. Infine, i lati della sella sono flessibili in modo da migliorare la stabilità e facilitare la pedalata.

Un design innovant en forme de vague pour vous aider à trouver immédiatement la bonne position sur votre VAE. Sa section arrière surélevée vous empêchera de glisser vers l'arrière pour assurer un confort maximal à votre dos, tandis que les côtés de la selle, d'une flexibilité unique, ajoutent de la stabilité et facilitent le pédalage.

Easy Handling



E-GRIP

Una maniglia gommata "soft-touch" integrata nella parte posteriore della sella facilita la manovrabilità della tua e-bike.

Tenez bien en main votre vélo électrique grâce à cette fonctionnalité intelligente : une poignée intégrée et douce au toucher qui facilite les manœuvres.

Less Waste



STRACCIATELLA

Stracciatella è un'innovativa tecnologia di imbottitura che incorpora le selle scartate dalla produzione. Macinata in granuli e iniettata in una nuova schiuma, Stracciatella riduce i rifiuti e favorisce un modello di produzione circolare. Come il famoso gelato italiano, la Stracciatella può essere gustata a ogni pedalata!

Stracciatella est une technologie de rembourrage innovante qui incorpore les selles mises au rebut lors de la production. Réduite en granulés et injectée dans une nouvelle mousse, Stracciatella réduit les déchets et favorise un modèle de production circulaire. Comme la célèbre glace italienne, la Stracciatella se déguste à chaque sortie !



RECYCLED PLASTIC BASE

La base in plastica 100% riciclata è realizzata con gli scarti di rifiuti elettrici ed elettronici, trasformati in materiali riciclati di alta qualità, pur mantenendo le stesse prestazioni di quelli tradizionali.

La base en plastique 100% recyclé est fabriquée à partir de déchets électriques et électroniques, transformés en produits recyclés de haute qualité tout en conservant les mêmes performances que les matériaux traditionnels.



All Journeys
Riding Everywhere





ON Athletic
Unisex

-  E-Fit Design
-  Royalgel™
-  E-Grip
-  Royal Vacuum
-  Integrated Clip System



ON Moderate
Unisex

-  E-Fit Design
-  Royalgel™
-  E-Grip
-  Royal Vacuum
-  Integrated Clip System



ON Relaxed
Unisex

-  E-Fit Design
-  Royalgel™
-  E-Grip
-  Royal Vacuum
-  Integrated Clip System



ARTICLE	EAN	NAME	RIDING POSITION	GENDER	SIZES	PRICE (€)
94C7UROA05X37	8021890570239	On	Athletic	Unisex	L 281mm / W 157mm / W 465g	89,90
94C8DROA05X37	8021890570260	On	Moderate	Unisex	L 268mm / W 190mm/ W 531g	89,90
94C9UROA05X37	8021890570291	On	Relaxed	Unisex	L 269mm / W 224mm / W 642g	89,90



ON OPEN Athletic
Unisex

-  Royal Vacuum
-  E-Fit Design
-  E-Grip
-  Royalgel™
-  Ergonomic Hole
-  Integrated Clip System



ON OPEN Moderate
Unisex

-  Royal Vacuum
-  E-Fit Design
-  E-Grip
-  Royalgel™
-  Ergonomic Hole
-  Integrated Clip System



ON OPEN Relaxed
Unisex

-  Royal Vacuum
-  E-Fit Design
-  E-Grip
-  Royalgel™
-  Ergonomic Hole
-  Integrated Clip System



ARTICLE	EAN	NAME	RIDING POSITION	GENDER	SIZES	PRICE (€)
94F6UROA05X37	8021890592477	On Open	Athletic	Unisex	L 281mm / W 158mm / W 443g	89,90
94F7DROA05X37	8021890592491	On Open	Moderate	Unisex	L 269mm / W 190mm / W 499g	89,90
94F8UROA05X37	8021890592514	On Open	Relaxed	Unisex	L 270mm / W 224mm / W 629g	89,90



RESPIRO Athletic
Unisex

- Royalgel™
- Ventilation Channel
- Cool Cover
- Scuff Guards
- Royal Vacuum
- Integrated Clip System



RESPIRO Moderate
Unisex

- Royalgel™
- Ventilation Channel
- Cool Cover
- Scuff Guards
- Elastomers
- Royal Vacuum
- Integrated Clip System



RESPIRO Relaxed
Unisex

- Royalgel™
- Ventilation Channel
- Cool Cover
- Scuff Guards
- Elastomers
- Royal Vacuum
- Integrated Clip System



ARTICLE	EAN	NAME	RIDING POSITION	GENDER	SIZES	PRICE (€)
5130HRTB691L4	8021890575098	Respiro	Athletic	Unisex	L 279mm / W 159mm / W 429g	79,90
5131HETB291L4	8021890578969	Respiro	Moderate	Unisex	L 277mm / W 182mm / W 535g	79,90
5132DETB291L4	8021890575104	Respiro	Relaxed	Unisex	L 256mm / W 227mm / W 771g	79,90

STRACCIATELLA



A new flavor in comfort

La nostra classica schiuma cremosa ora farcita con gustose scaglie di selle usate. La schiuma Stracciatella è una tecnologia proprietaria di Selle Royal che permette di creare nuovo materiale per l'imbottitura partendo dalla macinazione di selle vecchie o scartate.

Notre mousse classique, crémeuse, bourrée de savoureux copeaux de selles usagées. La mousse Stracciatella est une technologie exclusive de Selle Royal qui permet de créer un nouveau matériau de rembourrage à partir du broyage de selles anciennes ou mises au rebut.



LOOKIN Athletic Unisex

- Royalgel™
- Stracciatella
- Scuff Guards
- Royal Vacuum
- Integrated Clip System



LOOKIN Moderate Unisex

- Royalgel™
- Stracciatella
- Scuff Guards
- Elastomers
- Royal Vacuum
- Integrated Clip System



LOOKIN Relaxed Unisex

- Royalgel™
- Stracciatella
- Scuff Guards
- Elastomers
- Royal Vacuum
- Integrated Clip System



ARTICLE	EAN	NEW	NAME	RIDING POSITION	GENDER	SIZES	PRICE (€)
5234HR3A491B7	8021890619273	new	Lookin	Athletic	Unisex	L 279mm / W 160mm / W 440g	79,90
5235DE3A491B7	8021890619280	new	Lookin	Moderate	Unisex	L 269mm / W 198mm / W 620g	79,90
5236DE3A691B7	8021890619297	new	Lookin	Relaxed	Unisex	L 260mm / W 228mm / W 830g	79,90



LOOKIN EVO Athletic
Unisex

- Royalgel™
- Stracciatella
- Flexyte System
- Royal Vacuum
- Integrated Clip System
- Recycled Plastic Base



restyled



LOOKIN EVO Moderate
Unisex

- Royalgel™
- Stracciatella
- Flexyte System
- Royal Vacuum
- Integrated Clip System
- Recycled Plastic Base



restyled



LOOKIN EVO Relaxed
Unisex

- Royalgel™
- Stracciatella
- Flexyte System
- Elastomers
- Royal Vacuum
- Integrated Clip System
- Recycled Plastic Base



restyled

ARTICLE	EAN	NEW	NAME	RIDING POSITION	GENDER	SIZES	PRICE (€)
52E2UROA18096	8021890611444	new	Lookin Evo	Athletic	Unisex	L 261mm / W 158mm / W 448g	84,90
52E3HROA18096	8021890611451	new	Lookin Evo	Moderate	Unisex	L 271mm / W 186mm / W 500g	84,90
52E4UEOA18096	8021890611468	new	Lookin Evo	Relaxed	Unisex	L 248mm / W 223mm / W 682g	84,90

New windows but same iconic design

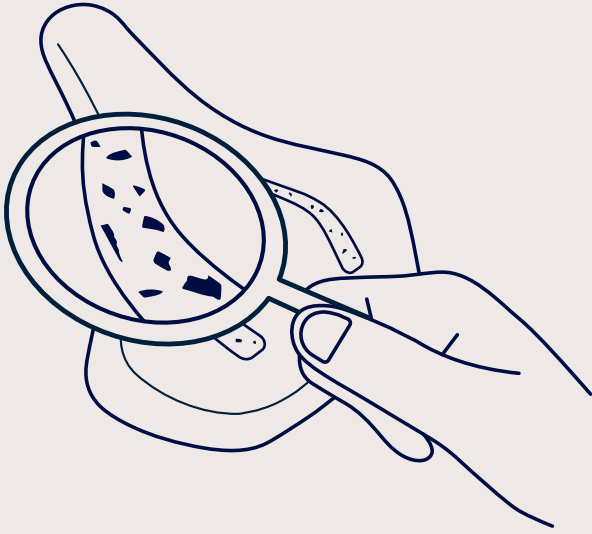

Dotate di finestre che consentono di vedere non solo il Royalgel™, ma ora anche l'imbottitura Stracciatella all'interno, queste selle sono state rinnovate per mettere in evidenza al meglio questi materiali innovativi, pur mantenendo il design unico per cui i prodotti Lookin sono conosciuti.

Avec des fenêtres qui permettent aux utilisateurs de voir non seulement le Royalgel™ mais aussi le rembourrage Stracciatella à l'intérieur, ces selles ont été redessinées pour mettre en valeur ces matériaux innovants tout en conservant le design unique pour lequel les produits Lookin sont connus.

Stracciatella highlight on packaging:

Con l'introduzione della tecnologia Stracciatella, i packaging di Lookin e Lookin Evo sono rinnovati come i prodotti stessi.

Una volta aperta, un simpatico cartellino pop-up sulla parte anteriore anticipa ai clienti questa nuova e fantastica tecnologia.

Avec l'introduction de la technologie Stracciatella, l'emballage de Lookin et Lookin Evo sera aussi frais que les produits eux-mêmes. Lorsqu'il sera ouvert, une étiquette fun située sur la face avant donnera aux clients "le scoop" de cette nouvelle technologie.

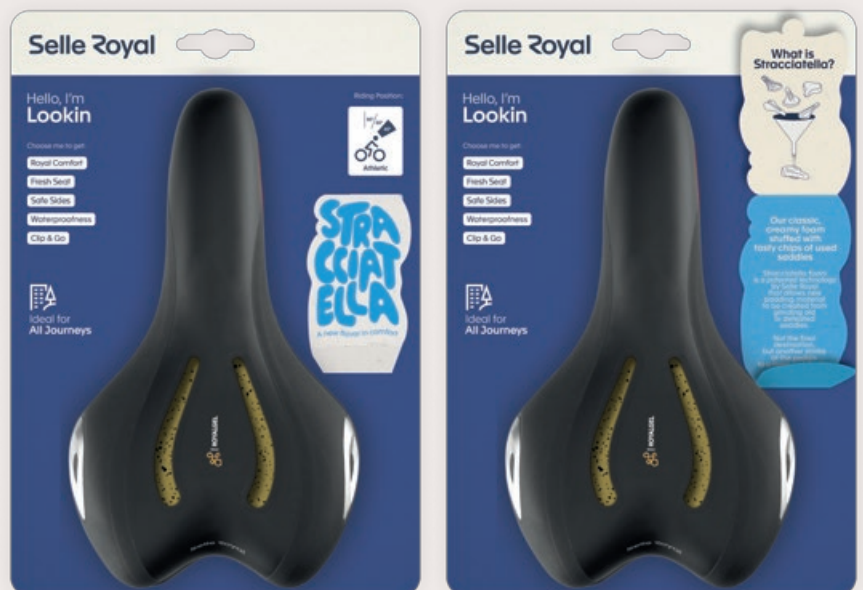



Adventure Time
Exploring Outdoors





EXPLORA Athletic
Unisex

-  Royalgel™
-  Ergonomic Channel
-  Royal Vacuum
-  Integrated Clip System



EXPLORA Moderate
Unisex

-  Royalgel™
-  Ergonomic Channel
-  Royal Vacuum
-  Integrated Clip System



EXPLORA Relaxed
Unisex

-  Royalgel™
-  Ergonomic Channel
-  Thermoplastic Damper
-  Royal Vacuum
-  Integrated Clip System



ARTICLE	EAN	NAME	RIDING POSITION	GENDER	SIZES	PRICE (€)
54D1UR0A05X38	8021890569721	Explora	Athletic	Unisex	L 274mm / W 152mm / W 379g	69,90
54D2HROA05X38	8021890569745	Explora	Moderate	Unisex	L 273mm / W 171mm / W 415g	69,90
54D3UE0A05X38	8021890569769	Explora	Relaxed	Unisex	L 253mm / W 218mm / W 598g	69,90



VAIA Athletic
Unisex

-  Royalgel™
-  Ergonomic Hole
-  Royal Vacuum
-  Integrated Clip System
-  Multi-Tool



VAIA Moderate
Unisex

-  Royalgel™
-  Ergonomic Hole
-  Royal Vacuum
-  Integrated Clip System
-  Multi-Tool



VAIA Relaxed
Unisex

-  Royalgel™
-  Ergonomic Hole
-  Thermoplastic Damper
-  Royal Vacuum
-  Integrated Clip System



ARTICLE	EAN	NAME	RIDING POSITION	GENDER	SIZES	PRICE (€)
84E5UROA05X38	8021890593504	Vaia	Athletic	Unisex	L 271mm / W 151mm / W 382g	69,90
84E6HROA05X38	8021890593511	Vaia	Moderate	Unisex	L 270mm / W 167mm / W 406g	69,90
84E7UEOA05X38	8021890593528	Vaia	Relaxed	Unisex	L 250mm / W 213mm / W 580g	69,90



88 FORCE

Selle Royal







Urban Life Moving in the City





ELLIPSE Athletic Unisex

-  Royalgel™
-  Ergonomic Hole
-  Double-Cover Side Protection
-  Royal Vacuum
-  Integrated Clip System



ELLIPSE Moderate Unisex

-  Royalgel™
-  Ergonomic Hole
-  Double-Cover Side Protection
-  Elastomers
-  Royal Vacuum
-  Integrated Clip System



ELLIPSE Relaxed Unisex

-  Royalgel™
-  Ergonomic Hole
-  Double-Cover Side Protection
-  Elastomers
-  Royal Vacuum
-  Integrated Clip System



ARTICLE	EAN	NAME	RIDING POSITION	GENDER	SIZES	PRICE (€)
81B5UR0A09320	8021890593474	Ellipse	Athletic	Unisex	L 265mm / W 163mm / W 406g	54,90
81B6HE0A09321	8021890593481	Ellipse	Moderate	Unisex	L 276mm / W 180mm / W 474g	54,90
81B7UE0A09321	8021890593498	Ellipse	Relaxed	Unisex	L 250mm / W 223mm / W 638g	54,90



Urban Life Moving in the City

new



VIVO Athletic Unisex



Royalgel™



Ergonomic
Channel



Reflective
Film



Royal
Vacuum



Integrated
Clip System



new



VIVO Moderate Unisex



Royalgel™



Ergonomic
Channel



Reflective
Film



Royal
Vacuum



Integrated
Clip System



new



VIVO Relaxed Unisex



Royalgel™



Ergonomic
Channel



Reflective
Film



Royal
Vacuum



Integrated
Clip System



ARTICLE	EAN	NEW	NAME	RIDING POSITION	GENDER	SIZES	PRICE (€)
84E1DROA08X14	8021890619624	new	Vivo	Athletic	Unisex	L 254mm / W 162mm / W 402g	54,90
84F2HROA08X14	8021890619631	new	Vivo	Moderate	Unisex	L 263mm / W 201mm / W 480g	54,90
84F2DROA08X14	8021890619648	new	Vivo	Relaxed	Unisex	L 267mm / W 178mm / W 480g	54,90



ERGONOMIC CHANNEL

Un canale progettato per seguire ergonomicamente la forma del corpo, offrendo sollievo dalla pressione nella zona perineale e supporto nella zona ischiatica. Niente più dolore durante le tue uscite in bicicletta!

Cette échancrure est conçue pour épouser de manière ergonomique la forme du corps, en apportant un soulagement de la pression dans les zones de tissus sensibles et un soutien dans la zone ischiatique. Pas de douleur, juste un avantage sur vos sorties!



ROYALGEL™

Superiore a qualsiasi altra imbottitura grazie alla sua formulazione unica, Royalgel™ è studiato per garantire il massimo livello di comfort. Durevole e versatile, questa tecnologia assorbe la pressione e la distribuisce su tutta la superficie della sella, garantendo un supporto ottimale anche nelle pedalate più lunghe.

Supérieur à tout autre matériau de rembourrage, le Royalgel™ offre le plus haut niveau de confort grâce à sa formulation unique. Durable et polyvalente, cette technologie absorbe la pression et la répartit sur la surface de la selle pour offrir le meilleur soutien, même pour vos plus longues sorties.

SOFT COVER

Una nuova copertina, più morbida e confortevole, che garantisce non solo una durata, ma anche un'esperienza di guida superiore.

Une nouvelle housse plus souple et plus confortable qui garantit non seulement la durabilité, mais offre également une expérience de conduite supérieure.



REFLECTIVE FILM

Essere visibili alle altre macchine mentre si pedala è di fondamentale importanza, negli spostamenti urbani tanto quanto nelle avventure fuoripista. Questa pellicola riflettente aumenta la tua visibilità: l'ideale in condizioni di scarsa luminosità o se la tua luce posteriore dovesse scaricarsi.

Que vous rouliez en ville ou que vous exploriez la nature, il est primordial de toujours être vu par les voitures, les vélos et les autres véhicules. Si, ou plutôt quand, votre feu arrière vous fait défaut, ce film réfléchissant protégera vos arrières pour une dose supplémentaire de sécurité.



ROYAL VACUUM

Rimani all'asciutto durante le tue pedalate! Progettata per resistere all'acqua, questa tecnologia brevettata da Selle Royal permette alla sella di essere sigillata al 100% e quindi impermeabile, anche quando esposta a forti intemperie.

Profitez d'un trajet au sec avec une selle résistante à l'eau. Cette technologie brevetée Selle Royal permet à la selle d'être 100% étanche et substantiellement imperméable, même lorsqu'elle est exposée à un temps lourd et humide.



FREEWAY FIT Athletic
Unisex



Slow Fit
Foam



Royal
Vacuum



Integrated
Clip System



FREEWAY FIT Moderate
Unisex



Slow Fit
Foam



Scuff
Guards



Royal
Vacuum



Integrated
Clip System



FREEWAY FIT Relaxed
Unisex



Slow Fit
Foam



Scuff
Guards



Royal
Vacuum



Integrated
Clip System



ARTICLE	EAN	NAME	RIDING POSITION	GENDER	SIZES	PRICE (€)
8V99UROA38069	8021890575623	Freeway Fit	Athletic	Unisex	L 280mm / W 158mm / W 435g	44,90
8V97DROA38069	8021890578891	Freeway Fit	Moderate	Unisex	L 260mm / W 188mm / W 520g	44,90
8V98UROA38069	8021890575616	Freeway Fit	Relaxed	Unisex	L 257mm / W 210mm / W 550g	44,90



FLOAT Athletic Unisex

-  Slow Fit Foam
-  Ergonomic Hole
-  Royal Vacuum
-  Integrated Clip System



FLOAT Moderate Unisex

-  Slow Fit Foam
-  Ergonomic Hole
-  Elastomers
-  Royal Vacuum
-  Integrated Clip System



FLOAT Relaxed Unisex

-  Slow Fit Foam
-  Ergonomic Hole
-  Elastomers
-  Royal Vacuum
-  Integrated Clip System



ARTICLE	EAN	NAME	RIDING POSITION	GENDER	SIZES	PRICE (€)
8VC1UR0A38V14	8021890575593	Float	Athletic	Unisex	L 267mm / W 161mm / W 382g	44,90
8VC2DE0A38V14	8021890579003	Float	Moderate	Unisex	L 263mm / W 200mm / W 547g	44,90
8VC3UE0A38V14	8021890575609	Float	Relaxed	Unisex	L 251mm / W 228mm / W 628g	44,90



AVENUE Athletic
Unisex



AVENUE Moderate
Unisex



AVENUE Relaxed
Unisex



ARTICLE	EAN	NAME	RIDING POSITION	GENDER	SIZES	PRICE (€)
8468HGOA28096	8021890575661	Avenue	Athletic	Unisex	L 265mm / W 158mm / W 462g	39,90
8466DGOA28096	8021890578907	Avenue	Moderate	Unisex	L 258mm / W 183mm / W 664g	39,90
8493DGOA28096	8021890575678	Avenue	Relaxed	Unisex	L 267mm / W 218mm / W 730g	39,90



DRIFTER STRENGTEX
Relaxed / Unisex



Royalgel™



Strengetex



Double Springs



Royal Vacuum



DRIFTER PLUS Relaxed
Unisex



Royalgel™



Double Springs



Royal Vacuum



ARTICLE	EAN	NAME	RIDING POSITION	GENDER	SIZES	PRICE (€)
5111UDTC95301	8021890575371	Drifter Strengetex	Relaxed	Unisex	L 270mm / W 245mm / W 1160g	54,90
5111UDTD08129	8021890575388	Drifter Plus	Relaxed	Unisex	L 270mm / W 245mm / W 1173g	54,90



ONDINA Relaxed Unisex



Royalgel™



Springs



Royal Vacuum



Integrated Clip System



HOLLAND Relaxed Unisex



Royalgel™



Springs



Royal Vacuum



Integrated Clip System



WITCH Relaxed Unisex



Foam Matrix



Springs



Royal Vacuum



ARTICLE	EAN	NAME	RIDING POSITION	GENDER	SIZES	PRICE (€)
8171US0A98129	8021890575630	Ondina	Relaxed	Unisex	L 253mm / W 214mm / W 690g	34,90
82615G2A18132	8021890575654	Holland	Relaxed	Unisex	L 247mm / W 219mm / W 690g	29,90
8013USTA18096	8021890581570	Witch	Relaxed	Unisex	L 260mm / W 243mm / W 651g	19,90



Kids saddles



Kids Saddles

new

EXPLORA JUNIOR Small (16" - 20") / Unisex

-  Foam Matrix
-  Ergonomic Channel
-  Royal Vacuum
-  Integrated Clip System



new

EXPLORA JUNIOR Medium (20" - 22") / Unisex

-  Foam Matrix
-  Ergonomic Channel
-  Royal Vacuum
-  Integrated Clip System



new

EXPLORA JUNIOR Large (22" - 24") / Unisex

-  Foam Matrix
-  Ergonomic Channel
-  Royal Vacuum
-  Integrated Clip System



ARTICLE	EAN	NEW	NAME	WHEEL SIZE	GENDER	SIZES	PRICE (€)
A056JROA05X38	6957312803819	new	Explora Junior Small	Kids 16" - 20"	Unisex	L 210mm / W 130mm / W 251g	24,90
A057JROA05X38	6957312803826	new	Explora Junior Medium	Kids 20" - 22"	Unisex	L 225mm / W 135mm / W 277g	24,90
A066JROA05X38	6957312803833	new	Explora Junior Large	Kids 22" - 24"	Unisex	L 245mm / W 150mm / W 325g	24,90

Accessories



Saddle bags

Saddle Bag Medium - 1,2L

Compatibile con Integrated Clip System, brugola inclusa, sistema di fissaggio esterno per luce.

Système de clip intégré compatible, clé allen incluse, clip d'éclairage externe.



Saddle Bag Large - 2,0L

Compatibile con Integrated Clip System, brugola inclusa, impermeabile, sistema di fissaggio esterno per luce.

Compatible avec le système de clip intégré, clé allen incluse, étanche, clip d'éclairage externe.



Saddle Bag Extra Large - 7,0L

Compatibile con Integrated Clip System, brugola inclusa, impermeabile, sistema di fissaggio esterno per luce, tracolla inclusa.

Système de clip intégré compatible, clé allen incluse, étanche, clip d'éclairage externe, bandoulière incluse.



ARTICLE	EAN	NAME	COVER	SIZES	PRICE (€)
BAGS300A00000	8021890494955	Saddle Bag Medium 1,2L	Polyester, PVC	L 210mm / W 95mm / H 115mm	24,90
BAGS400A00000	8021890494979	Saddle Bag Large 2,0L	Water Resistant Polyester, PVC	L 330mm / W 190mm / H 95mm	34,90
BAGS500A00000	8021890574916	Saddle Bag Extra Large 7,0L	Water Resistant Polyester, PVC	L 618mm / W 236mm / H 175mm	69,90

Seat Covers

Royalgel™ Seat Cover Small & Large - Unisex

Rientranza anatomica | Royalgel™ visibile
Empreinte anatomique | Royalgel™ visible



Slow Fit Foam Seat Cover Small & Large - Unisex

Rientranza anatomica | Slow Fit Foam
Empreinte anatomique | Slow Fit Foam



Rain Cover

Packable Rain Cover Dispenser / 10 pcs



ARTICLE	EAN	NAME	COLOR	SIZES	PRICE (€)
SCVM300A05800	6957312803116	Royalgel™ Seat Cover Small	Black/Orange	L 270mm / W 190mm / W 244g	19,90
SCVL300A05800	6957312803147	Royalgel™ Seat Cover Large	Black/Orange	L 248mm / W 221mm / W 254g	19,90
SCMM100A75800	6957312803109	Slow Fit Foam Seat Cover Small	Black	L 273mm / W 185mm / W 160g	19,90
SCML100A75800	6957312803130	Slow Fit Foam Seat Cover Large	Black	L 251mm / W 220mm / W 168g	19,90
SRSC000A00000	8021890574077	Packable Rain Cover Dispenser (10 pcs)	Black	L 107mm / W 120mm / H 258mm	11,90 each

Clamp

Clamp
Black / Silver



Spare parts



Vivo Ergo Athletic
Unisex / 15 pcs



new



Gipsy Relaxed
Unisex / 8 pcs



new



Rio Unitech Moderate
Unisex / 15 pcs



Holland Unitech Relaxed
Unisex / 10 pcs



CLAMP						
ARTICLE	EAN	NAME	COLOR	SIZES/QUANTITY	PRICE (€)	
V006000C00000	8021890472533	Clamp	Black	3 Components (Single Packaging)	3,00	
V006000B90000	8021890472526	Clamp	Silver	3 Components (Single Packaging)	2,50	
V006000C10000	8021890472540	Clamp	Silver	5 Components 38 D. (Single Packaging)	2,50	
V006000B70000	8021890324665	Clamp	Black	3 Components + Locknut	2,00	
V006000B60000	8021890324658	Clamp	Silver	3 Components + Locknut	2,00	
V006000B80000	8021890324672	Clamp	Silver	5 Components 38 D.	2,00	
SPARE PARTS*						
ARTICLE	EAN	NEW	NAME	RIDING POSITION	GENDER	QUANTITY/BOX
30E1HROA12010	8021890622846	new	Vivo Ergo	Athletic	Unisex	15 pcs
69545UDA52010	8021890447098	new	Gipsy	Relaxed	Unisex	8 pcs
3020DRMA12010	8021890498564		Rio Unitech	Moderate	Unisex	15 pcs
3061USOA12010	8021890485816		Holland Unitech	Relaxed	Unisex	10 pcs

(*) Gli Original Spare Parts by Selle Royal sono selle adibite al ricambio e vengono fornite in masterbox dedicati. Sono provviste di un apposito bindello descrittivo invece dell'appendisella. / Les "Original Spare Parts by Selle Royal" sont des pièces de rechange d'origine fournies en cartons contenant un nombre de pièces déterminé. Elles sont pourvues d'une notice explicative au lieu d'un "hang tag".



The ergonomic approach

Le selle **R.e.Med** sono state progettate per permettere al corpo di distribuire naturalmente lo stress in 3 zone della sella: **AZIONE, RECUPERO** e **SUPPORTO**, donando in questo modo sollievo e comfort, mantenendo una pressione inalterata se si cambia posizione tra il fronte ed il retro della sella.

Les selles **R.e.Med** ont été conçues pour permettre au corps de distribuer naturellement le stress sur 3 zones de la selle: **ACTION, RECUPERATION** et **SUPPORT**, procurant ainsi soulagement et confort même en maintenant une pression constante s'il l'on change de position par rapport au bec et à l'arrière de la selle.

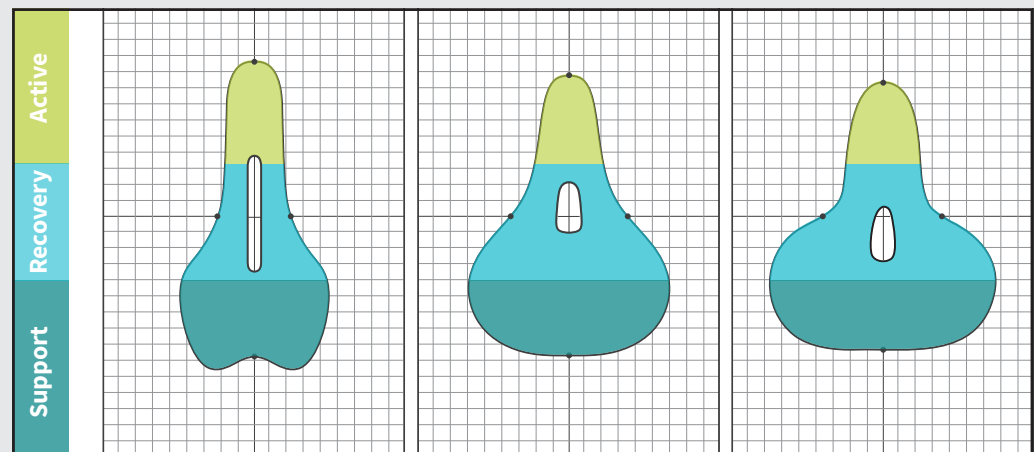

The features

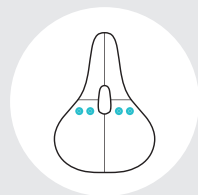

Specific Ergonomic Design



Handmade

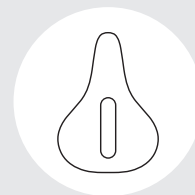

Anatomic Hole



Memory Foam

Remed



ARTICLE	EAN	NAME	RIDING POSITION	GENDER	SIZES	PRICE (€)
2354HRMA10004	6957312801471	Remed	Sport	Unisex	L 287mm / W 136mm / W 316g	26,90
4309DEMA10004	6957312801488	Remed	Trekking	Unisex	L 257mm / W 189mm / W 578g	26,90
5550UEMA10003	6957312801495	Remed	City	Unisex	L 249mm / W 207mm / W 633g	26,90

Remed Race



new

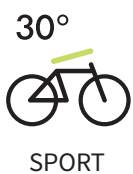

new

ARTICLE	EAN	NEW	NAME	RAIL	COLOR	GENDER	SIZES	PRICE (€)
2317HRNA00003	6957312803840	new	Remed Race Light	Carbon	Black	Unisex	L 250mm / W 145mm / 160g	99,90
2317HRNA00004	6957312803857	new	Remed Race	Cromoly	Black	Unisex	L 250mm / W 145mm / 208g	39,90

Remed Comfort Race



new



new

ARTICLE	EAN	NEW	NAME	RAIL	COLOR	GENDER	SIZES	PRICE (€)
2320HRNA00001	6957312803864	new	Remed Comfort Race	Cromoly	Black	Unisex	L 250mm / W 145mm / 228g	39,90
2320HRNA00002	6957312803871	new	Remed Comfort Race	Cromoly	Brown	Unisex	L 250mm / W 145mm / 228g	39,90

fi'zi:k





FIZIK SADDLE SELECTION GUIDE

In fizik crediamo fortemente nel supportare la migliore esperienza di pedalata possibile, e ciò include migliorare il benessere dei ciclisti, il loro comfort, la loro performance.

La sella è il punto di contatto più critico tra i ciclisti e la loro bici: per questo trovare la giusta sella può avere un effetto enorme. La scelta della sella giusta per sé richiede di considerare alcuni fattori chiave: è un tema da approfondire ma non deve risultare necessariamente complesso.

La nostra gamma è inclusiva, pensata per rispondere a diverse esigenze dei ciclisti, a prescindere dalla disciplina praticata, dalla posizione in bici, dalla conformazione fisica. Per semplificare la scelta, abbiamo realizzato questa guida in 5 step che può orientarti all'interno della nostra gamma, così da identificare la sella ideale per te.

Chiaramente, in fizik crediamo anche nella cultura e nell'educazione del bike fitting. Per qualsiasi dubbio, ricorda di chiedere supporto a uno specialista del settore.

Chez Fizik, nous croyons qu'il faut offrir la meilleure expérience de conduite possible, ce qui inclut l'amélioration du bien-être, du confort et de la performance individuelle du cycliste. La selle étant le point de contact le plus critique entre un cycliste et son vélo, l'ajustement de la selle peut avoir un effet considérable sur chacun de ces facteurs importants.

Le choix correct d'une selle nécessite plusieurs considérations clés, et bien qu'il s'agisse d'un sujet complexe, il n'est pas nécessaire de le compliquer. Notre gamme est structurée de manière à être complète et à répondre aux besoins des cyclistes, quelque soit la discipline, la position de conduite ou le type de corps.











Pour simplifier la sélection de la selle, nous avons élaboré un guide d'évaluation en cinq étapes qui peut vous aider à naviguer dans notre gamme et à identifier la selle idéale pour vous.

Bien entendu, chez Fizik, nous croyons et soutenons également la culture et l'éducation en matière de bike fitting. En cas de doute, n'oubliez pas de demander l'avis et l'assistance d'un revendeur ou d'un monteur de vélo qualifié.

1. RIDING STYLE

Che bici utilizzi? Realizziamo selle per ogni disciplina e per venire incontro alle caratteristiche della tua bici. Per questa ragione, partire dalla disciplina è un ottimo modo per raffinare la tua ricerca.

Quel type de vélo conduisez-vous ? Nous concevons des selles spécifiques pour chaque style de conduite et pour compléter la qualité de pilotage de votre vélo. Pour cette raison, la détermination de l'utilisation prévue est un excellent point de départ pour réduire le choix de la selle.

	ROAD Racing: Antares, Arione, Vento Argo
	ROAD All Round: Aliante, Tempo Argo
	TIME TRIAL: Aeris SD, Arione
	TRIATHLON: Aeris SD, Aeris LD
	GRAVEL Racing: Argo X, Antares
	GRAVEL All Round: Terra Argo, Aliante
	MTB XC Racing: Argo X, Antares
	MTB Trail : Aidon, Terra Alpaca
	MTB Trail E-bike: Aidon
	MTB Gravity: Terra Alpaca, Gravita Alpaca

3. PLATFORM

Oltre allo stile e alla forma, la prossima considerazione da fare è relativa alla piattaforma della sella. È la parte strutturale, consiste nel rail e nella socca ed è disponibile in 4 diverse combinazioni, dalla più leggera e dura alla più versatile e accessibile.

Au-delà du style et de la forme, la prochaine considération à prendre en compte est la plate-forme de la selle. La plateforme est la partie structurale de la selle, composée de la coque et du rail, que nous proposons en quatre combinaisons distinctes, de la plus légère et rigide à la plus polyvalente et accessible.

00

Rail in carbonio e scocca totalmente in carbonio per una sella ad alta rigidità e massimo risparmio di peso

La combinaison d'un rail carbone et d'une coque entièrement en carbone haut module pour une rigidité et une économie de poids inégalées

R1

Rail in carbonio e scocca in nylon rinforzato in carbonio, per reattività e comfort

La combinaison d'un rail carbone très rigide et d'une coque en nylon renforcée au carbone pour la réactivité et le confort

R3

Rail in Kium e scocca in nylon rinforzato in carbonio, per ottimo bilanciamento tra durezza e peso

La combinaison d'un rail Kium avec un rapport résistance/poids élevé et d'une coque en nylon renforcé au carbone

R5

Rail in alluminio e scocca in nylon rinforzata in carbonio, per performance affidabili a un prezzo accessibile

La combinaison d'un rail en alliage S-Alloy et d'une coque en nylon renforcé au carbone pour une performance fiable à un prix accessible



ON-LINE SADDLE FINDER

Per una selezione sella ancora più semplice, prova il nostro Saddle Finder online. È uno strumento facile da utilizzare che ti guiderà passo passo lungo tutto il processo. Puoi trovare un link alla pagina online su tutti i nostri appendisella, nel pratico QR code.

Pour une expérience de sélection de selle sans faille, essayez notre outil de Recherche de Selle en ligne Saddle Finder. Il s'agit d'un outil simple qui peut facilement vous guider tout au long du processus. Vous trouverez également un lien direct vers notre outil de recherche de selle sur chaque étiquette de selle.

2. SHAPE

Le selle sono disponibili in diverse forme e taglie, ma si possono racchiudere all'interno di quattro shape o forme. Scopri i tratti di ogni shape e per cosa sono stati pensati. Quale sembra essere quella per te?

Les selles se présentent sous de nombreuses formes et tailles, mais elles peuvent toutes être classées en quatre catégories principales. Apprenez les caractéristiques de chaque forme et ce pour quoi elles sont conçues. Laquelle correspond le mieux à vos besoins ?



T-SHAPE: sono selle con una transizione netta tra punta e ali, risultanti in una punta più lunga. In più, sono a profilo piatto. Questo porta maggiore spazio nel movimento gambe e consente diverse posizioni di seduta tra punta e coda. Le selle a T danno ai ciclisti la possibilità di cambiare facilmente posizione durante la pedalata, muovendosi lungo la punta per adottare una posizione più aerodinamica, e indietro per alzarsi sulla schiena. Ecco perché questa è la scelta di corridori competenti. **Selle: Antares, Arione**

T-SHAPE: les selles ont une transition abrupte entre le nez et l'aile, se traduisant par un nez plus long. En plus, leur profil est plus plat. Cela permet de dégager davantage l'intérieur des jambes et d'offrir plusieurs positions d'assise confortables d'avant en arrière. Les selles en forme de T permettent aux cyclistes de modifier facilement leur position assise pendant la sortie, en se déplaçant vers le nez lorsqu'ils adoptent une position de conduite plus avancée et aérodynamique et en se déplaçant vers l'arrière lorsqu'ils adoptent une position de conduite plus droite. C'est la raison pour laquelle ce type de selle est très prisé par les cyclistes expérimentés et les compétiteurs. **Selles : Antares, Arione**



V-SHAPE: selle con un affusolamento più graduale e con un profilo più ondulato. La forma della coda tende ad accogliere la zona lombare con maggiore supporto in rotazione del bacino, orientando i ciclisti sulla parte frontale. Le selle a V sono più indicate per ciclisti che cercano maggiore supporto e comfort, così come per chi ama godersi le lunghe distanze. **Selle: Aliante**

V-SHAPE: les selles s'évasent du nez vers l'arrière de façon plus graduelle, comme une pointe de flèche ou une poire. Elles ont généralement un profil latéral ondulé. L'arrière de la selle est incliné, ce qui permet de soulager le bas du dos, tandis que l'évasement progressif aide le cycliste à tourner le bassin, ce qui l'amène plus en avant. En raison de ces facteurs, les selles en V conviennent aux cyclistes qui ont besoin d'un soutien et d'un confort supplémentaires, ainsi qu'à ceux qui aiment parcourir de longues distances. **Selles : Aliante**



SHORT NOSE: Provviste di un naso più corto, quelle selle garantiscono una migliore definizione dell'area su cui posizionarsi, attraverso un maggiore supporto ischiatico. Come risultato, i ciclisti si trovano più stabili sulla sella, con un'oscillazione minore sulla superficie e migliore distribuzione del peso. È la nostra sella più versatile, offerta in varie opzioni a seconda della disciplina e dello stile di pedalata. **Selle: Vento Argo, Tempo Argo, Terra Argo, Argo X, Aeris Sd, Aidon, Terra Alpaca, Gravita Alpaca**

SHORT NOSE: avec un nez beaucoup plus court, ces selles offrent une zone plus définie pour s'asseoir, généralement en combinaison avec un soutien ischiatique généreux. En conséquence, les cyclistes sont plus ancrés sur le siège et bougent moins, privilégiant la stabilité et une meilleure répartition du poids. Il s'agit de notre forme de selle la plus polyvalente, c'est pourquoi nous la proposons dans de nombreuses options pour convenir à différents styles et disciplines. **Selles : Vento Argo, Tempo Argo, Terra Argo, Argo X, Aeris Sd, Aidon, Terra Alpaca, Gravita Alpaca**



SPLIT NOSE: selle, come da nome, dove la zona anteriore è suddivisa in due parti, dando supporto alla zona pubica e al tempo stesso alleviando pressione sui tessuti molli in fase di spinta sull'anteriore. Pensate appositamente per i triatleti sulle lunghe distanze che hanno bisogno di supporto ed equilibrio su varie ore spese in posizione aerodinamica. **Selle: Aeris Ld**

SPLIT NOSE: les selles, comme leur nom l'indique, ont un nez divisé en deux moitiés, ce qui permet de soutenir les branches du pubis et de soulager au maximum la pression sur les tissus mous lorsque l'on s'assoit en avant sur la pointe de la selle. Elles sont spécialement conçues pour les triathlètes de longue distance qui ont besoin d'un soutien ferme et d'un équilibre pour les longues heures passées en position aérodynamique. **Selles : Aeris Ld**

4. PADDING TECH

Il padding è l'interfaccia diretta tra i ciclisti e la loro bici: dal più minimale e leggero, al più progressivo e affidabile per le uscite più lunghe, fino alla nostra innovativa tecnologia Adaptive 3D che ha rivoluzionato i concetti di comfort e performance. Scopri di più qui sotto.

Le rembourrage est l'interface directe entre le cycliste et son vélo. De la technologie la plus minimale et la plus légère au rembourrage le plus progressif et le plus fiable pour des heures passées sur la selle, en passant par notre rembourrage innovant Adaptive imprimé en 3D qui a révolutionné le confort et la performance, découvrez nos différentes options de rembourrage ci-dessous.

ADAPTIVE Il nostro più avanzato padding stampato in 3D, realizzato con punti di pressione differenziati e pensato per adattarsi al corpo di ogni ciclista.

ADAPTIVE Notre rembourrage imprimé en 3D le plus avancé, conçu avec un amortissement zonal distinctif et réglé pour s'adapter au corps du cycliste.

PU FOAM La nostra classica formula proprietaria, sviluppata in decenni di ricerca ed esperienza nella realizzazione di selle. Il foam PU è a densità progressiva, resiliente e capace di offrire una performance consistente e durevole nel tempo.

PU FOAM Notre formule exclusive, développée après des décennies de recherche et d'expérience dans la fabrication de selles. La mousse PU est progressive, résiliente et offre des performances constantes et durables.

INJECTED EVA La nostra sella con copertina a basso profilo, pensata per offrire un feeling reattivo ai ciclisti e contemporaneamente risparmiare di peso. Questo padding si trova su tutte le piattaforme 00.













INJECTED EVA Notre rembourrage de selle sans revêtement et à profil bas a été conçu pour offrir une sensation de conduite réactive tout en réduisant le poids. Le rembourrage en EVA injecté est présent sur toutes les plateformes 00.

5. SIZE

Quando hai trovato la sella per te, l'ultimo step è scegliere la giusta taglia. La maggior parte delle selle sono disponibili in due larghezze. La taglia è influenzata in particolare dalla posizione di seduta sulla bici, cosa che si può determinare con un bike fitting accurato. In assenza di questo tuttavia, la misurazione delle ossa ischiatiche può essere una buona indicazione per la taglia delle selle. Puoi utilizzare il nostro tool dedicato ai negozi assieme alla nostra tabella taglie, oppure puoi approfondire il nostro saddle finder online, con le nostre raccomandazioni di taglia per ogni modello.

Une fois que vous avez identifié la selle idéale, la dernière étape consiste à choisir la bonne taille. La plupart de nos selles sont disponibles en deux largeurs. La taille de la selle est principalement influencée par la position assise sur le vélo, ce qui peut être déterminé par un bike fitting. Cependant, sans ce processus, la mesure de la distance entre les os de l'assise peut également constituer un bon indicateur de la taille de la selle. Pour cela, vous pouvez utiliser notre outil dédié en magasin ainsi que nos tableaux de tailles de selles—ou vous pouvez utiliser notre outil de recherche de selles en ligne depuis chez vous, et nous vous recommanderons la bonne taille pour chacun de nos modèles de selles.

SADDLE SELECTION GUIDE

	ARIONE	ANTARES	ALIANTE	VENTO ARGO	TEMPO ARGO	TERRA ARGO	ARGO X	AERIS SD	AERIS LD	AIDON	TERRA ALPACA	GRAVITA ALPACA
												
INTENDED USE	Road (racing)	Road (racing)	Road (all round)	Road (racing)	Road (all round)							
	Time Trial							Time Trial				
								Triathlon	Triathlon			
		Gravel (racing)	Gravel (all round)			Gravel (all round)	Gravel (racing)			MTB (trail/e-mtb)	MTB (trail)	MTB (gravity)
		MTB (XC racing)				MTB (trail/e-mtb)	MTB (XC racing)					
SHAPE	T-shape	T-shape	V-shape	Short Nose	Short Nose	Short Nose	Short Nose	Short Nose	Split Nose	Short Nose	Short Nose	Short Nose
AVAILABLE PLATFORMS	00	00		00								
	R1	R1	R1	R1	R1	X1	X1	R1	R1	X1		
	R3	R3	R3	R3	R3	X3	X3	R3	R3	X3		
	R5	R5	R5	R5	R5	X5	X5	R5	R5	X5	X5	X5
AVAILABLE PADDING TECH		Adaptive	Adaptive	Adaptive		Adaptive		Adaptive	Adaptive			
	PU Foam	PU Foam	PU Foam	PU Foam	PU Foam	PU Foam	PU Foam	PU Foam	PU Foam	PU Foam	PU Foam	PU Foam
		Injected EVA		Injected EVA								
AVAILABLE SIZES	130 mm	140 mm	145 mm	140 mm	150 mm	140 mm	140 mm	135 mm	135 mm	145 mm	145 mm	130 mm
	140 mm	150 mm	155 mm	150 mm	160 mm	150 mm	150 mm			160 mm		
						160 mm						

SIZE

Larghezza di sella suggerita in base alla larghezza delle ossa ischiatiche (in millimetri).
Quando le taglie si sovrappongono, entrambe combaciano con il fit indicato.

Largeur de selle suggérée par rapport à la largeur des ischions (mm).
Chevauchement lorsque deux tailles correspondent à l'ajustement.

*Le selle con una sola taglia disponibile non sono presenti in questo grafico.

*Les selles qui n'ont qu'une largeur disponible ne figurent pas dans ce tableau.



ROAD AND TRIATHLON SADDLES







fizik

Continental
58

V/R

VENTO
ARGO 00
ADAPTIVE

Intended use: ROAD RACING

Regular
L 265mm | W 140mm | W 175g
Large
L 265mm | W 150mm | W 186g



VENTO
ARGO R1
ADAPTIVE

Intended use: ROAD RACING, XC, CX

Regular
L 265mm | W 140mm | W 190g
Large
L 265mm | W 150mm | W 196g



VENTO
ARGO R3
ADAPTIVE

Intended use: ROAD RACING, XC, CX

Regular
L 265mm | W 140mm | W 224g
Large
L 265mm | W 150mm | W 230g



ARTICLE	EAN	MODEL	SIZE	COLOR	RAILS	SHELL	PADDING	SRP (€)
77F1D00A0P003	8021890583536	Vento Argo 00 Adaptive	140mm	Black	Carbon Mobius 7x9mm	Full Carbon	Adapitve Padding	399
77F2D00A0P003	8021890583543		150mm					399
70F1D00A0P002	8021890571090	Vento Argo R1 Adaptive	140mm	Black	Carbon 7x9mm	Carbon Reinforced Nylon	Adapitve Padding	299
70F2D00A0P002	8021890571113		150mm					299
70F1D00A1P002	8021890571106	Vento Argo R3 Adaptive	140mm	Black	Kium 7x7mm	Carbon Reinforced Nylon	Adapitve Padding	259
70F2D00A1P002	8021890571120		150mm					259

VENTO
ANTARES R1
ADAPTIVE

Intended use: ROAD RACING, XC

Regular

L 267mm | W 140mm | W 180g

Large

L 267mm | W 150mm | W 185g



VENTO
ANTARES R3
ADAPTIVE

Intended use: ROAD RACING, XC

Regular

L 267mm | W 140mm | W 220g

Large

L 267mm | W 150mm | W 225g



ARTICLE	EAN	MODEL	SIZE	COLOR	RAILS	SHELL	PADDING	SRP (€)
70F5D00A0P002	8021890589996	Vento Antares R1 Adaptive	140mm	Black	Carbon 7x9mm	Carbon Reinforced Nylon	Adapitve Padding	299
70F6D00A0P002	8021890590015		150mm					299
70F5D00A1P002	8021890590008	Vento Antares R3 Adaptive	140mm	Black	Kium 7x7mm	Carbon Reinforced Nylon	Adapitve Padding	259
70F6D00A1P002	8021890590022		150mm					259

TEMPO
ALIANTE R1
ADAPTIVE

Intended use: ROAD, GRAVEL

Regular

L 277mm | W 145mm | W 196g

Large

L 277mm | W 155mm | W 201g



TEMPO
ALIANTE R3
ADAPTIVE

Intended use: ROAD, GRAVEL

Regular

L 277mm | W 145mm | W 235g

Large

L 277mm | W 155mm | W 240g



ARTICLE	EAN	MODEL	SIZE	COLOR	RAILS	SHELL	PADDING	SRP (€)
70F7D00A0P002	8021890590039	Tempo Aliante R1 Adaptive	145mm	Black	Carbon 7x9mm	Carbon Reinforced Nylon	Adapitve Padding	299
70F8D00A0P002	8021890590053		155mm					299
70F7D00A1P002	8021890590046	Tempo Aliante R3 Adaptive	145mm	Black	Kium 7x7mm	Carbon Reinforced Nylon	Adapitve Padding	259
70F8D00A1P002	8021890590060		155mm					259

VENTO
ARGO 00

Intended use: ROAD RACING

Regular

L 265mm | W 140mm | W 134g

Large

L 265mm | W 150mm | W 139g



VENTO
ARGO R1

Intended use: ROAD RACING

Regular

L 265mm | W 140mm | W 179g

Large

L 265mm | W 150mm | W 186g



VENTO
ARGO R3

Intended use: ROAD RACING

Regular

L 265mm | W 140mm | W 213g

Large

L 265mm | W 150mm | W 220g



VENTO
ARGO R5

Intended use: ROAD RACING

Regular

L 265mm | W 140mm | W 225g

Large

L 265mm | W 150mm | W 232g



ARTICLE	EAN	MODEL	SIZE	COLOR	RAILS	SHELL	PADDING	SRP (€)
77D7Y00A0E000	8021890499271	Vento	140mm	Black	Carbon Mobius 7x9mm	Full Carbon	EVA Padding	299
77D8Y00A0E000	8021890499288	Argo 00	150mm					299
70D7S00A03A23	8021890486486	Vento	140mm	Black	Carbon 7x9mm	Carbon Reinforced Nylon with WingFlex	Type 1 Foam	199
70D8S00A03A23	8021890486516	Argo R1	150mm					199
70D7S00A13A22	8021890486493	Vento	140mm	Black	Kium 7x7mm	Carbon Reinforced Nylon with WingFlex	Type 1 Foam	149
70D8S00A13A22	8021890486523	Argo R3	150mm					149
70D7S00A23A22	8021890486509	Vento	140mm	Black	S-Alloy 7x7mm	Carbon Reinforced Nylon with WingFlex	Type 1 Foam	109
70D8S00A23A22	8021890486530	Argo R5	150mm					109

TEMPO
ARGO R1

Intended use: ROAD

Regular

L 260mm | W 150mm | W 195g

Large

L 260mm | W 160mm | W 202g



TEMPO
ARGO R3

Intended use: ROAD

Regular

L 260mm | W 150mm | W 229g

Large

L 260mm | W 160mm | W 235g



TEMPO
ARGO R5

Intended use: ROAD

Regular

L 260mm | W 150mm | W 241g

Large

L 260mm | W 160mm | W 247g



ARTICLE	EAN	MODEL	SIZE	COLOR	RAILS	SHELL	PADDING	SRP (€)
70D9S00A03A23	8021890486547	Tempo Argo R1	150mm	Black	Carbon Mobius 7x9mm	Carbon Reinforced Nylon with WingFlex	Type 2 Foam	199
70E0S00A03A23	8021890486578		160mm					199
70D9S00A13A22	8021890486554	Tempo Argo R3	150mm	Black	Kium 7x7mm	Carbon Reinforced Nylon with WingFlex	Type 2 Foam	149
70E0S00A13A22	8021890486585		160mm					149
70D9S00A23A22	8021890486561	Tempo Argo R5	150mm	Black	S-Alloy 7x7mm	Carbon Reinforced Nylon with WingFlex	Type 2 Foam	109
70E0S00A23A22	8021890486592		160mm					109

VENTO
ANTARES 00

Intended use: ROAD RACING, XC, CX

Regular

L 270mm | W 140mm | W 118g

Large

L 270mm | W 150mm | W 124g



VENTO
ANTARES R1

Intended use: ROAD RACING, XC, CX

Regular

L 268mm | W 140mm | W 161g

Large

L 268mm | W 150mm | W 166g



VENTO
ANTARES R3

Intended use: ROAD RACING, XC, CX

Regular

L 268mm | W 140mm | W 195g

Large

L 268mm | W 150mm | W 202g



VENTO
ANTARES R5

Intended use: ROAD RACING, XC, CX

Regular

L 268mm | W 140mm | W 210g

Large

L 268mm | W 150mm | W 217g



ARTICLE	EAN	MODEL	SIZE	COLOR	RAILS	SHELL	PADDING	SRP (€)
77E9Y00A0E000	8021890580375	Vento Antares 00	140mm	Black	Carbon 7x9mm	Full Carbon Shell	Injected EVA	299
77FOY00A0E000	8021890580382		150mm					299
75E5S00A03A25	8021890580191	Vento Antares R1	140mm	Black	Carbon 7x9mm	Carbon Reinforced Nylon with WingFlex	Double-Density Foam	199
75E6S00A03A25	8021890580221		150mm					199
75E5S00A13A25	8021890580207	Vento Antares R3	140mm	Black	Kium 7x7mm	Carbon Reinforced Nylon with WingFlex	Double-Density Foam	149
75E6S00A13A25	8021890580238		150mm					149
75E5S00A23A25	8021890580214	Vento Antares R5	140mm	Black	S-Alloy 7x7mm	Carbon Reinforced Nylon with WingFlex	Double-Density Foam	109
75E6S00A23A25	8021890580245		150mm					109

TEMPO
ALIANTE R1

Intended use: ROAD, GRAVEL

Regular

L 277mm | W 145mm | W 180g

Large

L 277mm | W 155mm | W 186g



TEMPO
ALIANTE R3

Intended use: ROAD, GRAVEL

Regular

L 277mm | W 145mm | W 220g

Large

L 277mm | W 155mm | W 226g



TEMPO
ALIANTE R5

Intended use: ROAD, GRAVEL

Regular

L 277mm | W 145mm | W 230g

Large

L 277mm | W 155mm | W 236g



ARTICLE	EAN	MODEL	SIZE	COLOR	RAILS	SHELL	PADDING	SRP (€)
75E7S00A03A25	8021890580252	Tempo Aliante R1	145mm	Black	Carbon 7x9mm	Carbon Reinforced Nylon with WingFlex	Double-Density Foam	199
75E8S00A03A25	8021890580283		155mm					199
75E7S00A13A25	8021890580269	Tempo Aliante R3	145mm	Black	Kium 7x7mm	Carbon Reinforced Nylon with WingFlex	Double-Density Foam	149
75E8S00A13A25	8021890580290		155mm					149
75E7S00A23A25	8021890580276	Tempo Aliante R5	145mm	Black	S-Alloy 7x7mm	Carbon Reinforced Nylon with WingFlex	Double-Density Foam	109
75E8S00A23A25	8021890580306		155mm					109

ARIONE 00

Intended use: ROAD RACING

L 298mm | W 124mm | W 140g



ARIONE R1

Intended use: ROAD RACING

Regular

L 300mm | W 126mm | W 165g

Large

L 300mm | W 140mm | W 175g



ARIONE R3

Intended use: ROAD

Regular

L 300mm | W 126mm | W 200g

Large

L 300mm | W 140mm | W 210g



ARIONE CLASSIC

Intended use: ROAD

L 300mm | W 132mm | W 235g



ARTICLE	EAN	MODEL	SIZE	COLOR	RAILS	SHELL	PADDING	SRP (€)
7092SWSA19C65	8021890428127	Arione 00	-	Black/Anthracite	Carbon Mobius 7x10mm	Full Carbon	Foam	299
76B5SWSA09C65	8021890443861	Arione R1	Regular	Black	Carbon Braided 7x10mm	Thermoplastic Carbon Composite with WingFlex	Foam	199
76BOSWSA09E12	8021890443830		Large					199
74B5SWSA09F04	8021890443816	Arione R3	Regular	Black	Kium 7x7mm	Thermoplastic Carbon Composite with WingFlex	Foam	149
74BOSWSA09C65	8021890443786		Large					149
7014SXSD99640	8021890276308	Arione Classic	-	Alcantara/Black	Kium 7x7mm	Carbon Reinforced Nylon with WingFlex	Foam	129

ARIONE R1 OPEN

Intended use: ROAD RACING

Regular

L 300mm | W 132mm | W 199g

Large

L 298mm | W 142mm | W 205g



ARIONE R3 OPEN

Intended use: ROAD

Regular

L 300mm | W 132mm | W 230g

Large

L 298mm | W 142mm | W 240g



ARTICLE	EAN	MODEL	SIZE	COLOR	RAILS	SHELL	PADDING	SRP (€)
70C0S00A03A02	8021890455642	Arione R1 Open	Regular	Black	Carbon Braided 7x10mm	Carbon Reinforced Nylon with WingFlex	Foam	199
70D0S00A03A02	8021890455703		Large					199
70C0S00A13041	8021890455659	Arione R3 Open	Regular	Black	Kium 7x7mm	Carbon Reinforced Nylon with WingFlex	Foam	149
70D0S00A13041	8021890455710		Large					149
70C0S00A13038	8021890460233	Arione R3 Open	Regular	White	Kium 7x7mm	Carbon Reinforced Nylon with WingFlex	Foam	149
70D0S00A13038	8021890460264		Large					149



FITZIK

SSIDE

TRANSIRO
AERIS LD R1 new
ADAPTIVE

Intended use: TRIATHLON / TIME TRIAL

L 242mm | W 135mm | W 190g



TRANSIRO
AERIS LD R3 new
ADAPTIVE

Intended use: TRIATHLON / TIME TRIAL

L 242mm | W 135mm | W 220g



TRANSIRO
AERIS SD R1 new
ADAPTIVE

Intended use: TRIATHLON / TIME TRIAL

L 243mm | W 135mm | W 159g



TRANSIRO
AERIS SD R3 new
ADAPTIVE

Intended use: TRIATHLON / TIME TRIAL

L 243mm | W 135mm | W 189g



ARTICLE	EAN	NEW	MODEL	SIZE	COLOR	RAILS	SHELL	PADDING	SRP (€)
70G5D00A0P002	8021890590121	new	Transiro Aeris LD R1 Adaptive	135mm	Black	Carbon 7x9mm	Carbon Reinforced Nylon	Adapitve Padding	299
70G5D00A1P002	8021890590138	new	Transiro Aeris LD R3 Adaptive	135mm	Black	Kium 7x7mm	Carbon Reinforced Nylon	Adapitve Padding	259
70G4D00A0P002	8021890590107	new	Transiro Aeris SD R1 Adaptive	135mm	Black	Carbon 7x9mm	Carbon Reinforced Nylon	Adapitve Padding	299
70G4D00A1P002	8021890590114	new	Transiro Aeris SD R3 Adaptive	135mm	Black	Kium 7x7mm	Carbon Reinforced Nylon	Adapitve Padding	259

TRANSIRO
AERIS LD R1

Intended use: TRIATHLON / TIME TRIAL

L 244mm | W 135mm | W 181g



TRANSIRO
AERIS LD R3

Intended use: TRIATHLON / TIME TRIAL

L 244mm | W 135mm | W 212g



TRANSIRO
AERIS LD R5

Intended use: TRIATHLON / TIME TRIAL

L 244mm | W 135mm | W 218g



ARTICLE	EAN	MODEL	SIZE	COLOR	RAILS	SHELL	PADDING	SRP (€)
75F3S00A03A25	8021890580313	Transiro Aeris LD R1	135mm	Black	Carbon 7x9mm	Carbon Reinforced Nylon	Type 1 Foam	199
75F3S00A13A25	8021890580320	Transiro Aeris LD R3	135mm	Black	Kium 7x7mm	Carbon Reinforced Nylon	Type 1 Foam	149
75F3S00A23A25	8021890580337	Transiro Aeris LD R5	135mm	Black	S-Alloy 7x7mm	Carbon Reinforced Nylon	Type 1 Foam	109

TRANSIRO
AERIS SD R1

Intended use: TRIATHLON / TIME TRIAL

L 245mm | W 135mm | W 170g



TRANSIRO
AERIS SD R3

Intended use: TRIATHLON / TIME TRIAL

L 245mm | W 135mm | W 199g



TRANSIRO
AERIS SD R5

Intended use: TRIATHLON / TIME TRIAL

L 245mm | W 135mm | W 209g



ARTICLE	EAN	MODEL	SIZE	COLOR	RAILS	SHELL	PADDING	SRP (€)
75F4S00A03A25	8021890580344	Transiro Aeris SD R1	135mm	Black	Carbon 7x9mm	Carbon Reinforced Nylon	Type 1 Foam	199
75F4S00A13A25	8021890580351	Transiro Aeris SD R3	135mm	Black	Kium 7x7mm	Carbon Reinforced Nylon	Type 1 Foam	149
75F4S00A23A25	8021890580368	Transiro Aeris SD R5	135mm	Black	S-Alloy 7x7mm	Carbon Reinforced Nylon	Type 1 Foam	109

OFF-ROAD SADDLES

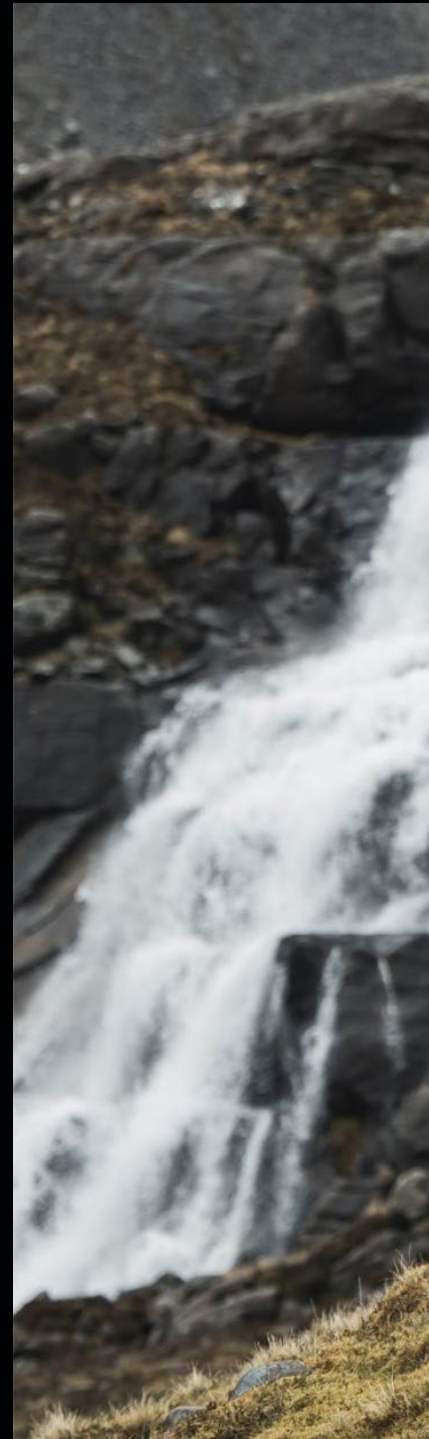





TERRA

ARGO X1 new
ADAPTIVE

Intended use: GRAVEL, MTB

Regular

L 270mm | W 140mm

Large

L 270mm | W 150mm



TERRA

ARGO X3 new
ADAPTIVE

Intended use: GRAVEL, MTB

Regular

L 270mm | W 140mm

Large

L 270mm | W 150mm



ARTICLE	EAN	NEW	MODEL	SIZE	COLOR	RAILS	SHELL	PADDING	SRP (€)
70F9D00A0PF02	8021890619303	new	Terra Argo X1 Adaptive	140mm	Black	Carbon Mobius 7x9mm	Carbon Reinforced Nylon	Adapitve Padding	299
70E1D00A0PF02	8021890619310	new		150mm					299
70F9D00A1PF02	8021890619327	new	Terra Argo X3 Adaptive	140mm	Black	Kium Mobius 7x7mm	Carbon Reinforced Nylon	Adapitve Padding	259
70E1D00A1PF02	8021890619334	new		150mm					259

TERRA
ARGO X1

Intended use: GRAVEL

140mm
L 270mm | W 140mm | W 210g
150mm
L 270mm | W 150mm | W 215g
160mm
L 270mm | W 160mm | W 225g



TERRA
ARGO X3

Intended use: GRAVEL

140mm
L 270mm | W 140mm | W 253g
150mm
L 270mm | W 150mm | W 258g
160mm
L 270mm | W 160mm | W 262g



TERRA
ARGO X5

Intended use: GRAVEL

140mm
L 270mm | W 140mm | W 265g
150mm
L 270mm | W 150mm | W 271g
160mm
L 270mm | W 160mm | W 275g



ARTICLE	EAN	MODEL	SIZE	COLOR	RAILS	SHELL	PADDING	SRP (€)
70F9S00A03A22	8021890590077		140mm					199
70E1S00A23A22	8021890571199	Terra Argo X1	150mm	Black	Carbon Mobius 7x9mm	Carbon Reinforced Nylon with WingFlex	Type 2 Foam	199
70E2S00A23A22	8021890571205		160mm					199
70F9S00A13A22	8021890590084		140mm					149
70E1S00A03A22	8021890498052	Terra Argo X3	150mm	Black	Kium Mobius 7x7mm	Carbon Reinforced Nylon with WingFlex	Type 2 Foam	149
70E2S00A03A22	8021890498076		160mm					149
70F9S00A23A22	8021890590091		140mm					109
70E1S00A13A22	8021890486615	Terra Argo X5	150mm	Black	S-Alloy Mobius 7x7mm	Carbon Reinforced Nylon with WingFlex	Type 2 Foam	109
70E2S00A13A22	8021890486639		160mm					109

VENTO
ARGO X1

Intended use: OFF-ROAD RACING

Regular

L 265mm | W 140mm | W 192g

Large

L 265mm | W 150mm | W 198g



VENTO
ARGO X3

Intended use: OFF-ROAD RACING

Regular

L 265mm | W 140mm | W 231g

Large

L 265mm | W 150mm | W 237g



VENTO
ARGO X5

Intended use: OFF-ROAD RACING

Regular

L 265mm | W 140mm | W 240g

Large

L 265mm | W 150mm | W 246g



ARTICLE	EAN	MODEL	SIZE	COLOR	RAILS	SHELL	PADDING	SRP (€)
F212URNA27881	6957312803291	Vento Argo X1	140mm	Black	Carbon 7x9mm	Fiber Reinforced Nylon with WingFlex	Type 1 Foam	199
F213URNA27881	6957312803314		150mm					199
F212URNA17881	6957312803277	Vento Argo X3	140mm	Black	Kium 7x7mm	Fiber Reinforced Nylon with WingFlex	Type 1 Foam	149
F213URNA17881	6957312803284		150mm					149
F212URNA07881	6957312803253	Vento Argo X5	140mm	Black	S-Alloy 7x7mm	Fiber Reinforced Nylon with WingFlex	Type 1 Foam	109
F213URNA07881	6957312803260		150mm					109

TERRA
ALPACA X5
+ CARRIAGE KIT

Intended use: ENDURO, ALL-MOUNTAIN

L 248mm | W 145mm | W 230g

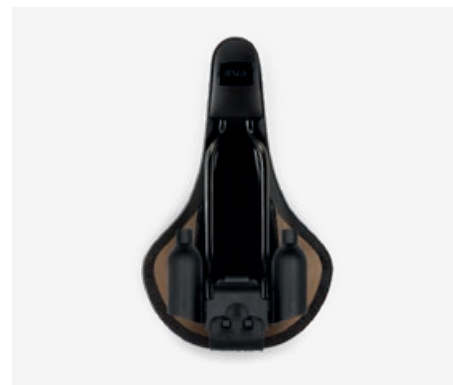

GRAVITA
ALPACA X5
+ CARRIAGE KIT

Intended use: ENDURO, DOWNHILL

L 251mm | W 130mm | W 216g



ARTICLE	EAN	MODEL	COLOR	RAILS	SHELL	PADDING	SRP (€)
F206URNA13814	6957312802447	Terra Alpaca X5 + Carriage Kit	Black	S-Alloy Mobius 7x7mm	Fiber Reinforced Nylon with EdgeFlex	Foam	99
F205URNA13814	6957312802430	Gravita Alpaca X5 + Carriage Kit	Black	S-Alloy Mobius 7x7mm	Fiber Reinforced Nylon with EdgeFlex	Foam	89

TERRA
AIDON X1

Intended use: E-MTB, MTB

Regular

L 255mm | W 145mm | W 205g

Large

L 255mm | W 160mm | W 215g



TERRA
AIDON X3

Intended use: E-MTB, MTB

Regular

L 255mm | W 145mm | W 249g

Large

L 255mm | W 160mm | W 259g



TERRA
AIDON X5

Intended use: E-MTB, MTB

Regular

L 255mm | W 145mm | W 262g

Large

L 255mm | W 160mm | W 272g



ARTICLE	EAN	MODEL	SIZE	COLOR	RAILS	SHELL	PADDING	SRP (€)
F208URNA24873	6957312802485	Terra Aidon X1	145mm	Black	Carbon Mobius 7x9mm	Fiber Reinforced Nylon with WingFlex	Type 2 Foam	179
F209URNA24873	6957312802515		160mm					179
F208URNA14873	6957312802478	Terra Aidon X3	145mm	Black	Kium Mobius 7x7mm	Fiber Reinforced Nylon with WingFlex	Type 2 Foam	139
F209URNA14873	6957312802508		160mm					139
F208URNA04873	6957312802461	Terra Aidon X5	145mm	Black	S-Alloy Mobius 7x7mm	Fiber Reinforced Nylon with WingFlex	Type 2 Foam	89
F209URNA04873	6957312802492		160mm					89

VENTO
ANTARES TEST KIT

1 Vento Antares R5 - 140mm
1 Vento Antares R5 - 150mm



TEMPO
ALIANTE TEST KIT

1 Tempo Aliante R5 - 145mm
1 Tempo Aliante R5 - 155mm



TRANSIRO
AERIS TEST KIT

1 Transiro Aeris SD R5
1 Transiro Aeris LD R5



VENTO & TEMPO
ARGO TEST KIT

1 Vento Argo R3 - 140mm
1 Vento Argo R3 - 150mm
1 Tempo Argo R3 - 150mm
1 Tempo Argo R3 - 160mm



TERRA
ARGO TEST KIT

1 Terra Argo X3 - 150mm
1 Terra Argo X3 - 160mm



ARTICLE	EAN	MODEL	DESCRIPTION
FZKS000D30000	8021890580399	Vento Antares Test Kit	2 Vento Antares R5, both sizes, test cosmetics
FZKS000D40000	8021890580405	Tempo Aliante Test Kit	2 Tempo Aliante R5, both sizes, test cosmetics
FZKS000D50000	8021890580412	Transiro Aeris Test Kit	1x Transiro Aeris SD R5 and 1x Transiro Aeris LD R5, test cosmetics
FZKS000000000	8021890486448	Vento & Tempo Argo Test Kit	4 R3 Vento e Tempo Argo Test Saddles (2 Regular + 2 Large)
FZKS000C50000	8021890498397	Terra Argo Test Kit	2 X3 Terra Argo Test Saddles (1 Regular + 1 Large)

SADDLE BAG SMALL

Disegnata per alloggiare una camera d'aria, una cartuccia di CO2 e i levagomme.

Realizzata in durevole PU-rivestito in poliestere con cuciture saldate.

- Tasca interna in rete
- Zip idrorepellente
- Si aggancia sotto la sella con uno strap Velcro
- Volume di 0,4 litri
- Dimensioni 110x75x50 mm
- Peso: 66g

Conçu pour contenir une chambre à air, une cartouche de CO2 et les démonte pneus.

Fabriqué en polyester durable enduit de PU avec coutures soudées.

- Poche intérieure en filet
- Zip déperlant
- Il s'accroche sous la selle avec une sangle Velcro
- Volume de 0,4 litre
- Dimensions 110x75x50 mm
- Poids: 66g



AERIS LINK

Weight: 14g

Permette l'attacco posteriore di un portaborraccia alle selle Aeris SD e LD.

Permet de fixer un porte-bidon à l'arrière des selles Aeris SD et LD.



BOTTLE CAGE

Weight: 29g

Portaborraccia progettato per essere integrato alla sella Aeris, compatibile con tutti i supporti standard con filettatura a 2 fori.

Développé pour être intégré au maillon de la selle Aeris, ce porte-bidon est compatible avec tous les supports standards à 2 trous.



ARTICLE	EAN	MODEL	SIZE	COLOR	DESCRIPTION	SRP (€)
FB09000A00000	8021890497130	Saddle Bag	One Size	Black	PU-coated polyester / Inner mesh pocket / Water repellent zipper / Velcro straps	25
FZKS000D70000	8021890586698	Aeris Link	One Size	Black	Enables rear attachment of a water bottle cage to Aeris SD and LD saddles	15
FZKS000D20000	8021890579805	Bottle Cage	One Size	Black	Designed to be integrated with the Aeris saddle link, the bottle cage is compatible with all bike frames with standard 2 threaded holes	15

CLOSURE SYSTEMS

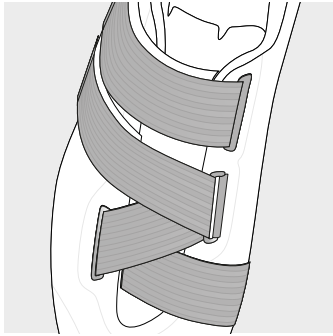

POWERSTRAP

È un'innovativa chiusura Velcro disegnata per una calzata avvolgente. Mentre la maggior parte delle chiusure Velcro tengono semplicemente assieme due lati della tomaia, in questo caso un nastro si avvolge attorno al piede, garantendo un comfort e un contenimento superiori utilizzando solo due straps.

Il s'agit d'une fermeture Velcro innovante conçue pour un ajustement parfait. Alors que la plupart des fermetures Velcro maintiennent simplement deux côtés de la tige ensemble, dans ce cas, un ruban s'enroule autour du pied, assurant un confort et un ajustement supérieurs en utilisant seulement deux sangles.

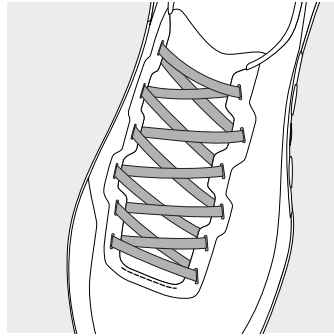

LACE

I lacci avvolgono il piede e si adattano alla sua forma, assicurando una calzata naturale. In questo modo, la pressione viene distribuita in modo uniforme su tutto il piede, evitando la formazione di punti critici.

Les lacets enveloppent le pied et s'adaptent à une variété de formes de pieds, sécurisant l'ajustement avec une sensation plus naturelle. Avec les lacets, la pression est répartie uniformément sur l'ensemble du pied, sans créer de points de chaleur.

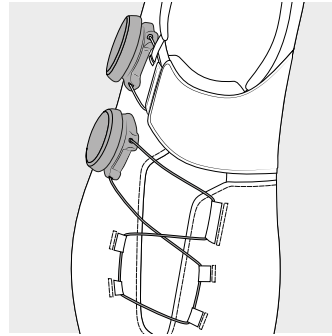

DOUBLE BOA®

Permette di regolare separatamente la calzata per le aree del collo del piede e dell'avampiede, la cui forma e volume possono variare notevolmente da un ciclista all'altro. Attraverso il controllo di due chiusure BOA® indipendenti, il ciclista può regolare con precisione la calzata della scarpa in base alla forma del proprio piede, per comfort e sostegno personalizzati.

Permet un réglage différencié de l'ajustement pour les zones du cou-de-pied et de l'avant-pied, dont la forme et le volume peuvent varier considérablement d'un cycliste à l'autre. En contrôlant les deux cadrans BOA® distincts, les cyclistes peuvent adapter la chaussure à la forme unique de leur pied pour un confort et un soutien personnalisés.

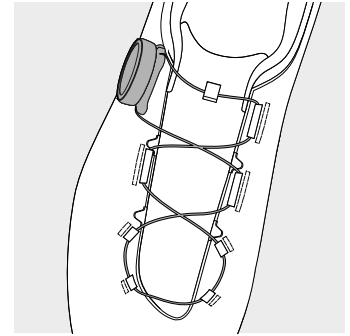

SINGLE BOA®

Un sistema di chiusura veloce e sicuro, grazie alla chiusura BOA® micro-regolabile che garantisce una vestibilità perfetta.

Un système de fermeture rapide et sûr, alimenté par une molette BOA® micro-réglable pour un ajustement précis.

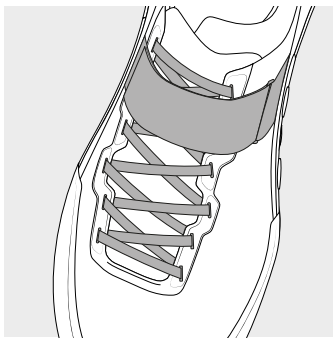

LACES + STRAP

Un sistema di allacciatura ergonomico che avvolge il piede e distribuisce la pressione in modo uniforme durante la pedalata. Oltre a fissare i lacci, il Powerstrap sul collo del piede assicura una calzata stabile sostenendo l'arco plantare e bloccando il tallone.

Un modèle ergonomique à lacets qui enveloppe le pied et répartit la tension de manière homogène tout au long du coup de pédale. Le Powerstrap sur le cou-de-pied sécurise l'ajustement en stabilisant la voûte plantaire et en bloquant le talon en place tout en gardant les lacets sous contrôle.

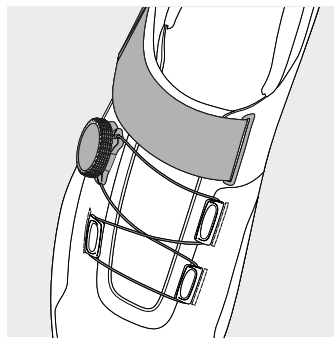

STRAP + BOA®

Sistema di chiusura doppio con strap in velcro e BOA®. Lo strap sul collo del piede garantisce la massima stabilità e un sostegno ottimale, mentre il BOA® Fit System nell'avampiede assicura una calzata di precisione micro-regolabile.

Système de fermeture double avec une sangle velcro et un cadran BOA®. Sur le cou-de-pied, une sangle permet de contenir le pied de manière exceptionnelle, tout en offrant un système infaillible. En outre, un système BOA® Fit est situé à l'avant-pied, assurant un ajustement d'une précision micro-ajustable.

UPPER MATERIALS

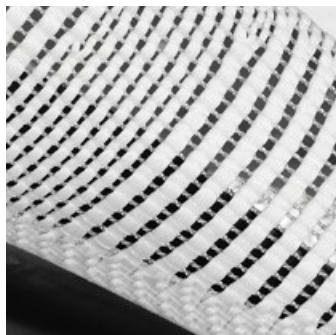

AEROWEAVE

Un tessuto avanzato che intreccia fibre di leggero nylon con filamenti di polimero termoplastico. Questa miscela di fili crea un materiale con una struttura aperta, simile a una rete, estremamente areata, ma altamente resistente e resiliente. Aeroweave è un materiale malleabile: si muove per cullare adeguatamente il piede, ma la sua tenacia assicura il supporto e il contenimento necessari per una scarpa da gara ad alte prestazioni.

Un tissu à l'avant garde qui tisse des fibres de nylon légères avec des filaments de polymère thermoplastique. Ce mélange de fils crée un matériau à structure ouverte, semblable à un filet, extrêmement aéré, mais très résistant et élastique. Aeroweave est un matériau malléable: il bouge pour bien préserver le pied, mais sa tenue assure le maintien et le confinement nécessaires à une chaussure de course performante.



PU LAMINATED

Tomaia in materiale resiliente laminato in poliuretano combinato con un comodo tessuto a rete, in grado di garantire una maggiore robustezza, un sostegno del piede duraturo e una migliore traspirabilità dove è più necessario.

La partie supérieure est composée d'un matériau laminé en polyuréthane résistant combiné à une maille confortable, ce qui permet de réduire le rendement et d'offrir un soutien durable du pied et une ventilation améliorée là où c'est le plus nécessaire.



MICROTEX

Tomaia in materiale sintetico simile alla vera pelle: flessibile e allo stesso tempo resistente, per una calzata confortevole e durevole nel tempo.

Tige en matière synthétique ayant les capacités du cuir véritable: flexible et en même temps résistant, pour un ajustement confortable et durable.



RIPSTOP

Il Ripstop è un tessuto leggero e durevole con un'elevata resistenza a strappi e lacerazioni. La sua robustezza è dovuta all'inserimento di resistenti filati di rinforzo durante la tessitura, intrecciati a intervalli regolari.

Le Ripstop est un tissu tissé léger et résistant qui offre une haute résistance aux déchirures. Pendant le tissage, des fils de renfort plus résistants sont entrelacés à intervalles réguliers selon un motif hachuré pour réduire l'étalement des déchirures.



GORETEX

La membrana GORE-TEX traspirante e impermeabile mantiene i piedi asciutti in qualsiasi condizione atmosferica, consentendo al sudore evaporato di fuoriuscire facilmente. Le nostre scarpe invernali sono dotate inoltre di una morbida fodera in pile, per calore e comfort anche nelle giornate fredde.

La membrane GORE-TEX respirante et imperméable garde les pieds au sec par tous les temps tout en permettant à la vapeur de la transpiration de s'échapper facilement. Dans nos chaussures d'hiver, une doublure en polaire brossée douce apporte chaleur et confort lors des sorties froides.

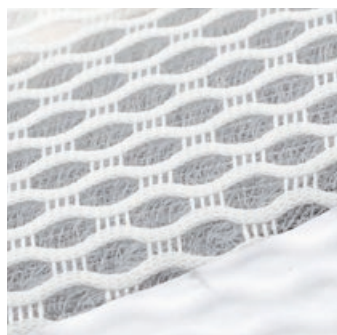

3D AIR MESH

Una tomaia in mesh altamente traspirante e morbida che aiuta a mantenere i piedi asciutti e a migliorare la traspirabilità.

Une construction de l'empeigne en mesh, très respirante et souple, permet de garder les pieds au sec et d'améliorer la ventilation.

ROAD OUTSOLES

new

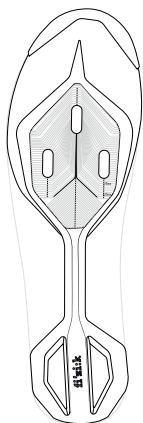

VEGA

INDICE DI RIGIDITÀ 10

Suola integrata in carbonio che offre il massimo della rigidità contenendo il peso. La nuova forma e il drop ridotto aumentano la stabilità e il supporto del piede, permettendo un trasferimento di potenza più efficiente.

INDICE DE RIGIDITÉ 10

Semelle en carbone intégrée qui offre une rigidité maximale tout en conservant un faible poids. La nouvelle forme et le drop réduit améliorent la stabilité et le soutien du pied, permettant un transfert de puissance plus efficace.

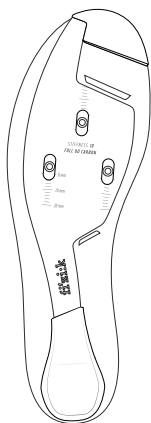

R2

INDICE DI RIGIDITÀ 10

Suola R2 in carbonio: posizionamento delle tacchette ottimizzato, alta rigidità e leggerezza finalizzate alla massima trasmissione di potenza.

INDICE DE RIGIDITÉ 10

Semelle carbone R2: positionnement optimisé des fixations des cale-pédales, rigidité et légèreté élevées pour une transmission de puissance maximale.

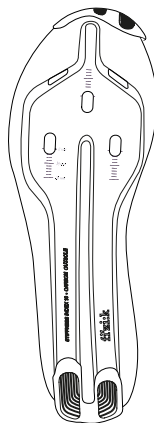

R3

INDICE DI RIGIDITÀ 10

La soluzione definitiva in termini di rigidità e leggerezza. Una suola in carbonio per una posizione ottimizzata delle tacchette e progettata per il massimo trasferimento di potenza.

INDICE DE RIGIDITÉ 10

L'ultime en matière de rigidité et de légèreté. Une semelle extérieure en carbone pour un positionnement optimisé des cales et un transfert de puissance maximal.

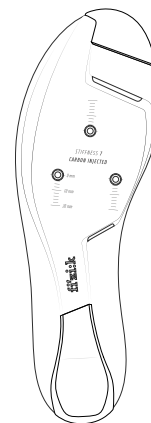

R4

INDICE DI RIGIDITÀ 7

Suola R4 in carbonio iniettato: moderatamente rigida per trasferire la potenza in modo confortevole.

INDICE DE RIGIDITÉ 7

Semelle en carbone injecté R4: moyennement rigide pour transférer la puissance en tout confort.

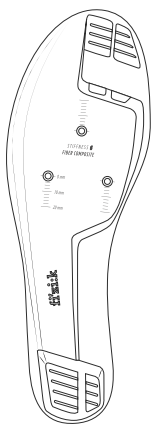

R5

INDICE DI RIGIDITÀ 6

Suola R5 in nylon e composito: bilancia comfort ed efficienza nella pedalata.

INDICE DE RIGIDITÉ 6

Semelle en nylon et composite R5: équilibre confort et efficacité lors du pédalage.

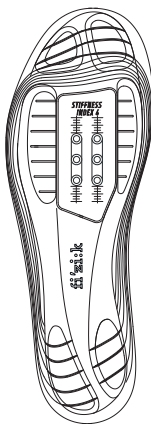

new

BEAT

INDICE DI RIGIDITÀ 4

Una suola innovativa dotata di una pista per tacchette a due bulloni nascosta. La rigidità mirata e il battistrada in TPU progettato per superfici miste bilanciano comfort, efficienza nella pedalata e trazione quando non si pedala. Usato previsto: Strada, Gravel

INDICE DE RIGIDITÉ 4

Une semelle extérieure innovante qui abrite une zone cachée pour les cales à deux vis. Une rigidité ciblée et une surface en TPU conçue pour les terrains mixtes, équilibrant le confort, l'efficacité du pédalage et l'adhérence en dehors du vélo. Utilisation prévue : Route, Gravel

OFF-ROAD OUTSOLES

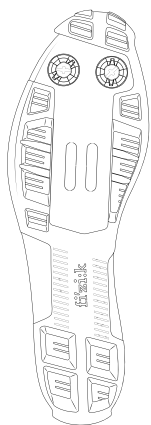

X1

INDICE DI RIGIDITÀ 10

Suola UD in carbonio, un'interfaccia con rigidità per la competizione, con durevole battistrada in TPU. Utilizzo indicato: Cross-Country, Ciclocross.

INDICE DE RIGIDITÉ 10

Semelle en carbone UD, une interface avec rigidité pour la compétition, avec semelle externe en TPU durable. Utilisation indiquée : VTT, Cyclocross.

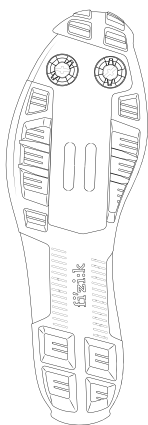

X3

INDICE DI RIGIDITÀ 8

Materiale in fibra composita per garantire elevata rigidità e un efficiente trasferimento di potenza, con una suola in gomma per il comfort. Utilizzo indicato: XC, CX, Gravel.

INDICE DE RIGIDITÉ 8

Fibre composite pour une haute rigidité et un transfert de puissance efficace avec une semelle extérieure en caoutchouc pour le confort. Utilisation indiquée : XC, CX, Gravel.

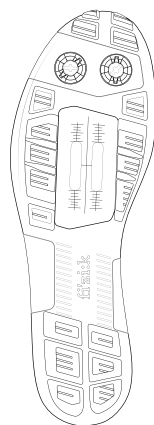

X5

INDICE DI RIGIDITÀ 5

Nylon rinforzato con un durevole battistrada in TPU. Utilizzo indicato: Cross Country, Ciclocross, Gravel Bike.

INDICE DE RIGIDITÉ 5

Nylon renforcé avec semelle externe en TPU durable. Utilisation indiquée : VTT, Cyclocross, Gravel.

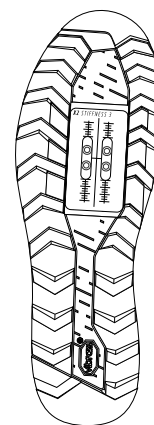

X2

INDICE DI RIGIDITÀ 3

Battistrada in Vibram per la trazione sui pedali e a piedi. Utilizzo indicato: Trail.

INDICE DE RIGIDITÉ 3

Semelle externe Vibram pour la traction en pédalant et pour les parties pédestres. Utilisation appropriée : Trail.

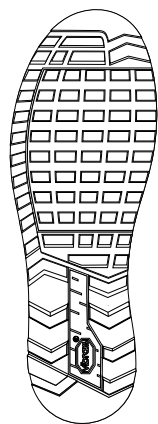

X2 FLAT

INDICE DI RIGIDITÀ 2

La mescola Vibram Megagrip combinata con il design del battistrada Fizik assicura un grip eccellente sui pedali flat e massima trazione anche durante la camminata. Utilizzo indicato: All-Mountain, Gravel, Bikepacking.

INDICE DE RIGIDITÉ 2

Le composé Vibram Megagrip combiné au design de la semelle fizik assure l'adhérence sur les pédales plates et une bonne traction en dehors du vélo. Utilisation indiquée : All-Mountain, Gravel, Bikepacking.

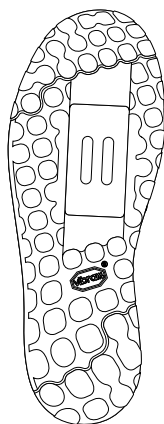

X6

INDICE DI RIGIDITÀ 5

La mescola e il disegno dei tasselli di Vibram® XS Trek EVO sono studiati per favorire il grip sui pedali e il massimo controllo della bicicletta per una guida gravity veloce e aggressiva. La guida per le tacchette estesa della versione clip-in consente un posizionamento delle tacchette più arretrato, per ottenere una migliore stabilità e un maggiore controllo in discesa grazie a una posizione del tallone più ribassata. Utilizzo indicato: DH-Enduro.

INDICE DE RIGIDITÉ 5

Le composé et le motif des crampons Vibram® XS Trek EVO sont conçus pour l'adhérence des pédales et le contrôle du vélo lors des sorties rapides et agressives en descente. Dotée d'une piste de crampons allongée, la version pour pédales automatiques vous permet de placer vos cales plus en arrière pour permettre de laisser tomber les talons dans les descentes, améliorant ainsi la stabilité et le contrôle. Utilisation indiquée : DH-Enduro.

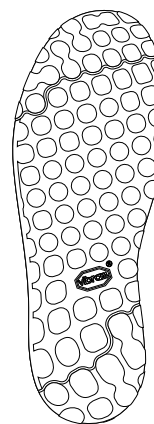

X6 FLAT

INDICE DI RIGIDITÀ 2

La mescola Vibram Megagrip e il disegno dei tasselli sono studiati per favorire il grip sui pedali e il massimo controllo della bicicletta per una guida gravity veloce e aggressiva. Utilizzo indicato: DH-Enduro.

INDICE DE RIGIDITÉ 2

Le composé Vibram Megagrip et le motif des crampons sont conçus pour assurer l'adhérence des pédales et le contrôle du vélo lors des sorties rapides et agressives en descente. Utilisation indiquée : DH-Enduro.

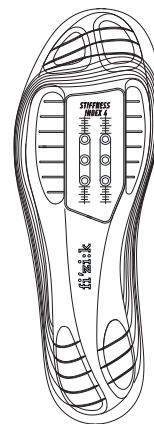

BEAT

INDICE DI RIGIDITÀ 4

Una suola innovativa dotata di una pista per tacchette a due bulloni nascosta. La rigidità mirata e il battistrada in TPU progettato per superfici miste bilanciano comfort, efficienza nella pedalata e trazione quando non si pedala. Uso previsto: Strada, Gravel

INDICE DE RIGIDITÉ 4

Une semelle extérieure innovante qui abrite une zone cachée pour les cales à deux vis. Une rigidité ciblée et une surface en TPU conçue pour les terrains mixtes, équilibrant le confort, l'efficacité du pédalage et l'adhérence en dehors du vélo. Utilisation prévue : Route, Gravel

new

ROAD AND TRIATHLON SHOES





VEGA new CARBON

Intended use: ROAD RACING

Double Boa: attraverso il controllo di due chiusure BOA indipendenti, la calzata della scarpa può essere regolata con precisione in base alla forma del piede, per un comfort e sostegno personalizzati

Aeroweave e PU Laminated upper: il nostro materiale più avanzato con una struttura a rete aperta, estremamente areata, accoppiato ad un mesh con laminazioni in punti strategici per aumentarne la resistenza e sostenere meglio il piede senza aggiungere peso

Vega Outsole: suola integrata in carbonio che offre il massimo della rigidità contenendo il peso. La nuova forma e il drop ridotto aumentano la stabilità e il supporto del piede, permettendo un trasferimento di potenza più efficiente

Double Boa : Deux fermetures BOA indépendantes permettent un ajustement précis à la forme du pied pour un confort et un soutien personnalisés

Aeroweave e PU Laminated upper : Notre matériau le plus avancé avec une structure en maille ouverte extrêmement respirante associée à une maille avec des laminations stratégiques pour accroître la durabilité et mieux soutenir le pied sans ajouter de poids

Vega Outsole : Semelle en carbone intégrée qui offre une rigidité maximale tout en conservant un faible poids. La nouvelle forme et le drop réduit améliorent la stabilité et le soutien du pied, permettant un transfert de puissance plus efficace

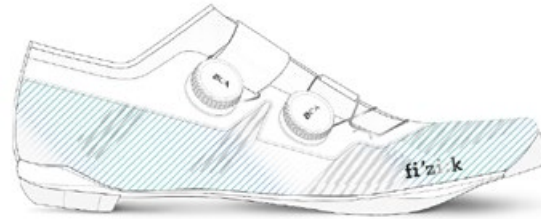

ARTICLE	EAN	NEW	MODEL	COLOR	SIZE	OUTSOLE	CLOSURE	UPPER	SRP (€)
VER1DMR1C2020	Various	new		White/White	36-48*				390
VER1DMR1C1510	Various	new	Vega Carbon	Coal Black/Black	36-48*	Full Carbon	2x Boa Li2 Dial A	Aeroweave and PU Laminated Mesh	390
VER1DMR1C2090	Various	new		White/Yellow Fluo	36-48*				390

Tutti i modelli sono disponibili nelle taglie piene | Tous les modèles sont disponibles en tailles pleines

(*) Modello disponibile anche nelle taglie: **42½, 43½, 44½** | Egalement disponible dans les tailles: **42½, 43½, 44½**

VENTO
**INFINITO KNIT
 CARBON 2**

Intended use: ROAD RACING

Weight: 225g

Infito: controllo ottimizzato del volume nell'area dell'avampiede

Volume Control: regolazione indipendente sul collo del piede e sull'avampiede

Knitted Upper: costruzione superventilata, con un supporto in TPU termosaldato

R2 Carbon Fiber Oustole: posizionamento ottimizzato delle tacchette, elevata rigidità e leggerezza ottimizzate per il trasferimento della potenza

Infito : contrôle précis du volume de la zone de l'avant-pied

Volume Control : ajustement indépendant de l'ajustement pour le cou-de-pied et l'avant-pied

Knitted Upper : construction extrêmement ventilée avec fil TPU thermofusible de soutien

R2 Carbon Fiber Oustole : positionnement optimisé des fixation des cales, rigidité et légèreté élevées pour un transfert de puissance maximal



ARTICLE	EAN	MODEL	COLOR	SIZE	OUTSOLE	CLOSURE	UPPER	SRP (€)
VER2IKR1C1010	Various	Vento Infito Knit	Black/Black**	36-48*	Full Carbon	2x BOA®	Knitted	380
VER2IKR1C9610	Various	Carbon 2	Coral/Black**		Unidirectional	Li2 B dials		380

Tutti i modelli sono disponibili nelle taglie piene | Tous les modèles sont disponibles en tailles pleines

(*) Modello disponibile anche nelle taglie: **42½, 43½, 44½** | Egalement disponible dans les tailles: **42½, 43½, 44½**

(**) Fino ad esaurimento scorte | Jusqu'à épuisement des stocks

VENTO INFINITO CARBON 2

Intended use: ROAD RACING

Weight: 227g

Infinito: controllo ottimizzato del volume nell'area dell'avampiede

Volume Control: regolazione indipendente sul collo del piede e sull'avampiede

Microtex Upper: morbida ma resistente e durevole, per una calzata comoda e durevole

R2 Carbon Fiber Oustole: posizionamento ottimizzato delle tacchette, elevata rigidità e leggerezza ottimizzate per il trasferimento della potenza

Infinito : contrôle précis du volume de la zone de l'avant-pied

Volume Control : ajustement indépendant de l'ajustement pour le cou de pied et l'avant-pied

Microtex Upper : souple mais solide et durable pour un ajustement confortable et précis

R2 Carbon Fiber Oustole : positionnement optimisé des fixation des cales pour un transfert de puissance maximal



ARTICLE	EAN	MODEL	COLOR	SIZE	OUTSOLE	CLOSURE	UPPER	SRP (€)
VER2IXR1C2010	Various	Vento Infinito	White/Black**	36-48*	Full Carbon	2x BOA®	Microtex	380
VER2IXR1C1010	Various	Carbon 2	Black/Black**		Unidirectional	Li2 B dials		380

Tutti i modelli sono disponibili nelle taglie piene | Tous les modeles sont disponibles en tailles pleines

(*) Modello disponibile anche nelle taglie: **42½, 43½, 44½** | Egalement disponible dans les tailles: **42½, 43½, 44½**

(**) Fino ad esaurimento scorte | Jusqu'à épuisement des stocks

VENTO

POWERSTRAP AEROWEAVE CARBON

Intended use: ROAD RACING

Weight: 184g

Aeroweave: struttura a rete estremamente traspirante e ad alta tenacità

Powerstrap: chiusura a strappo progettata per una calzata avvolgente

R3 Carbon Outsole: posizionamento ottimizzato delle tacchette, rigidità e leggerezza per una massima trasmissione di potenza

Aeroweave : structure extrêmement respirante, en forme de filet à haute résistance

Powerstrap : fermeture velcro enrobant le pied, conçue pour un ajustement enveloppant

R3 Carbon Outsole : positionnement optimisé des cales, rigidité et légèreté ultimes pour un transfert de puissance maximal



new colour



ARTICLE	EAN	NEW	MODEL	COLOR	SIZE	OUTSOLE	CLOSURE	UPPER	SRP (€)
VER3PAR1C2020	Various		Vento Powerstrap	White/White	36-48*	Full Carbon	Powerstrap	Aeroweave	350
VER3PAR1C3F5D	Various	new	Aeroweave Carbon	Light Violet/Neon Green	36-48*				350

Tutti i modelli sono disponibili nelle taglie piene | Tous les modèles sont disponibles en tailles pleines

(*) Modello disponibile anche nelle taglie: **42½, 43½, 44½** | Egalement disponible dans les tailles: **42½, 43½, 44½**

TEMPO DECOS CARBON

Intended use: ROAD RACING

Weight: 205g

PU laminate over mesh upper: aerazione migliorata, supporto dove questo è necessario

R2 Carbon fiber outsole: posizionamento ottimizzato delle tacchette, elevata rigidità e leggerezza ottimizzate per il trasferimento della potenza

PU laminate over mesh upper : ventilation améliorée avec soutien là où c'est le plus nécessaire

R2 Carbon fiber outsole : positionnement optimisé des fixation des cales pédales, rigidité élevée et légèreté optimisées pour le transfert de puissance



TEMPO DECOS CARBON WIDE

Calzata larga: fornisce più spazio sull'avampiede, sviluppando un volume maggiore e più spazio al metatarso

Fit large: offre plus d'espace sur l'avant-pied, développant un plus grand volume et plus d'espace dans le métatarsien



ARTICLE	EAN	MODEL	COLOR	SIZE	OUTSOLE	CLOSURE	UPPER	SRP (€)
TPR2BMR1C1010	Various		Black/Black					290
TPR2BMR1C2020	Various	Tempo Decos Carbon	White/White	36-48*	Full Carbon Unidirectional	Li2 BOA® Fit System	PU Laminate Over Mesh	290
TPR2BMR1C9910	Various		Iridescent Blue					290
TPR2BMR1C3610	Various		Aubergine**					290
TPR2BMW1C2020	Various	Tempo Decos Wide	White/White	36-48*	Full Carbon Unidirectional	Li2 BOA® Fit System	PU Laminate Over Mesh	290

Tutti i modelli sono disponibili nelle taglie piene | Tous les modèles sont disponibles en tailles pleines

(*) Modello disponibile anche nelle taglie: **42½, 43½, 44½** | Egalement disponible dans les tailles: **42½, 43½, 44½**

(**) Fino ad esaurimento scorte | Jusqu'à épuisement des stocks

TEMPO

BEAT new

Intended use: ROAD / ALL-ROAD / LIGHT GRAVEL

Weight: 355g

Engineered mesh upper: tomaia morbida e traspirante per un comfort duraturo

Lace-up closure: sistema di chiusura affidabile progettato per una calzabilità senza pressione e la massima regolabilità

Outsole: battistrada in TPU con rinforzo in nylon, indice di rigidità 4

Engineered mesh upper : tige souple et respirante pour un confort durable

Lace-up closure : système de fermeture fiable conçu pour un ajustement sans pression et une ajustabilité infini

Outsole : semelle en TPU avec une tige en nylon, indice de rigidité 4



ARTICLE	EAN	NEW	MODEL	COLOR	SIZE	OUTSOLE	CLOSURE	UPPER	SRP (€)
TPRSEMR1K1010	Various	new		Black/Black	36-48				179
TPRSEMR1K2031	Various	new	Beat	White/Orange	36-48	TPU Tread with a Nylon Shank	Lace-up	Engineer Mesh	179
TPRSEMR1K5676	Various	new		Sage Green/Desert	36-48				179

Tutti i modelli sono disponibili nelle taglie piene | Tous les modèles sont disponibles en tailles pleines

TEMPO OVERCURVE R4

Intended use: ROAD

Weight: 230g

Overcurve: costruzione asimmetrica che si adegua ergonomicamente all'anatomia del piede

PU laminate over mesh upper: aerazione migliorata, supporto dove questo è necessario

R4 Carbon Injected Outsole: moderatamente rigida per un trasferimento di potenza ottimale nel rispetto del comfort

Overcurve : construction asymétrique qui s'adapte ergonomiquement à l'anatomie du pied

PU laminate over mesh upper : aération améliorée, avec un support là où cela est nécessaire

R4 Carbon Injected Outsole : moyennement rigide pour un transfert de puissance optimal tout en respectant le confort

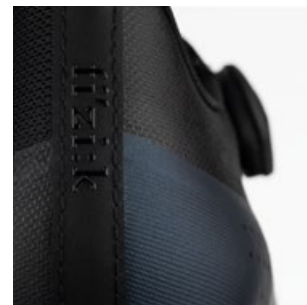

TEMPO OVERCURVE R4 WIDE

Calzata larga: fornisce più spazio sull'avampiede, sviluppando un volume maggiore e più spazio al metatarso

Fit large: offre plus d'espace sur l'avant-pied, développant un plus grand volume et plus d'espace dans le métatarsien



ARTICLE	EAN	MODEL	COLOR	SIZE	OUTSOLE	CLOSURE	UPPER	SRP (€)
TPR4OXR1K1010	Various	Tempo Overcurve R4	Black/Black	36-48	Carbon Injected Nylon	1x BOA® Li2 dial F Fit System	PU Laminated Mesh	219
TPR4OXR1K2010	Various		White/Black					219
TPR4OXR1K4210	Various		Navy/Black**					219
TPR4OIR1K8310	Various		Copper/Black Iridescent**					219
TPR4OIR1K8410	Various		Beetle/Black Iridescent**					219
TPR4OXW1K1010	Various	Tempo Overcurve R4 Wide	Black/Black	36-48	Carbon Injected Nylon	1x BOA® Li2 dial F Fit System	PU Laminated Mesh	219

(**) Fino ad esaurimento scorte | Jusqu'à épuisement des stocks

**VENTO
OMNA**

Intended use: ROAD

Weight: 238g

R5 Nylon Outsole: posizionamento ottimizzato delle tacchette con un indice di rigidità moderato

Perforated high-density PU upper: un materiale resistente e leggero che rende la scarpa confortevole e durevole al tempo stesso

Ready to race: calzata performante, regolabile tramite una singola chiusura BOA® bidirezionale

R5 Nylon Outsole : Positionnement optimisé des crampons avec un indice de rigidité modéré

Perforated high-density PU upper : Un revêtement résistant et léger qui rend la chaussure confortable tout en conservant sa durabilité

Ready to race : Un ajustement performant, réglable grâce à une molette BOA® bidirectionnelle unique

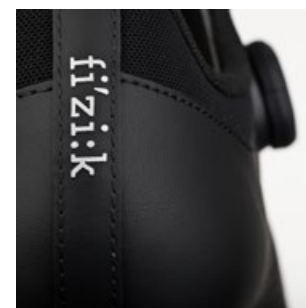

**VENTO
OMNA WIDE**

Calzata larga: fornisce più spazio sull'avampiede, sviluppando un volume maggiore e più spazio al metatarso

Fit large: offre plus d'espace sur l'avant-pied, développant un plus grand volume et plus d'espace dans le métatarsien



ARTICLE	EAN	MODEL	COLOR	SIZE	OUTSOLE	CLOSURE	UPPER	SRP (€)
VER5BPR1K1010	Various		Black/Black	36-48*				159
VER5BPR1K2010	Various		White/Black	36-48				159
VER5BPR1K3010	Various	Vento Omna	Red/Black**	36-48	R5 Nylon	1x BOA® Li2 dial F Fit System	PU	159
VER5BPR1K7510	Various		Metallic Gun Metal/Black**	36-48				159
VER5BPR1K3A10	Various		Cherry/Black**	36-48				159
VER5BPW1K2010	Various	Vento Omna Wide	White/Black	36-48	R5 Nylon	1x BOA® Li2 dial F Fit System	PU	159

Tutti i modelli sono disponibili nelle taglie piene | Tous les modèles sont disponibles en tailles pleines

(*) Modello disponibile anche nelle taglie: **42½, 43½, 44½** | Egalement disponible dans les tailles: **42½, 43½, 44½**

(**) Fino ad esaurimento scorte | Jusqu'à épuisement des stocks

TEMPO

POWERSTRAP R5

Intended use: ROAD

Weight: 255g

Powerstrap: chiusura con Velcro che avvolge il piede.
Disegnata per una calzata avvolgente
R5 nylon composite outsole: permette di bilanciare comfort ed efficienza nella pedalata

Powerstrap : fermeture velcro qui enveloppe le pied.
Conçu pour un ajustement enveloppant
R5 nylon composite outsole : permet d'équilibrer confort et efficacité lors du pédalage



ARTICLE	EAN	MODEL	COLOR	SIZE	OUTSOLE	CLOSURE	UPPER	SRP (€)
TPR5PSPU21010	Various	Tempo Powerstrap R5	Black/Black	36-48	Carbon Reinforced Nylon	Foot-wrapping Velcro	PU	129
TPR5PSPU22010	Various		White/Black					129
TPR5PSRE17410	Various		Reflective Grey/Black					129

TEMPO

ARTICA R5 GTX

Intended use: ROAD

Weight: 319g

GORE-TEX Koala membrane: isolata, impermeabile e traspirante, la membrana Koala di GORE-TEX ti mantiene caldo e asciutto durante le rigide giornate invernali

Fleeced Lining: la morbida fodera in pile spazzolato aggiunge isolamento e comfort alle tue uscite anche nei giorni più freddi

All-day comfort: vestibilità generosa e regolazioni facili grazie al pratico BOA® Fit System a rotella singola e allo strap in velcro

R5 Nylon Outsole: posizionamento ottimizzato delle tacchette con un indice di rigidità moderato

GORE-TEX Koala membrane : isolante, imperméable et respirante, la membrane Koala de GORE-TEX vous garde au chaud et au sec dans les conditions de sortie hivernales les plus difficiles

Fleeced Lining : La doublure douce en polaire brossée ajoute de l'isolation et du confort lors des sorties hivernales les plus froides

All-day comfort : La coupe généreuse et les ajustements faciles sont fournis par un système d'ajustement pratique à cadran unique BOA® et une sangle sécurisée en velcro

R5 Nylon Outsole : positionnement optimisé des crampons avec un indice de rigidité modéré



ARTICLE	EAN	MODEL	COLOR	SIZE	OUTSOLE	CLOSURE	UPPER	SRP (€)
TPR5AGR1V1010	Various	Tempo	Black/Black	40-48	R5 nylon	1x BOA® L6 dial & Ankle Velcro Strap	High-density PU Upper + Ripstop Fabric	269
TPR5AGR1V2070	Various	Artica R5 GTX	White/Grey					269

TRANSIRO
HYDRA AEROWEAVE
CARBON

Intended use: TRIATHLON

Weight: 225g

Aeroweave: struttura a rete estremamente traspirante e robusta

Fast Transitions: strap in velcro sul collo del piede per transizioni rapide

R2 Carbon Fiber Outsole: interamente in carbonio

Aeroweave : structure en forme de maille extrêmement respirante et à haute ténacité.

Fast Transitions : bande velcro sur le cou-de-pied pour une transition rapide

R2 Carbon Fiber Outsole : entièrement en carbone



ARTICLE	EAN	MODEL	COLOR	SIZE	OUTSOLE	CLOSURE	UPPER	SRP (€)
TRR2PAR1K2080	Various	Transiro Hydra Aeroweave Carbon	White/Silver	36-48	Full Carbon Unidirectional	Instep Velcro Strap	Aeroweave	290
TRR2PAR1K20RB	Various		White/Red-Blue					290

Tutti i modelli sono disponibili nelle taglie piene | Tous les modèles sont disponibles en tailles pleines

(*) Modello disponibile anche nelle taglie: **42½, 43½, 44½** | Egalement disponible dans les tailles: **42½, 43½, 44½**

**TRANSIRO
HYDRA**

Intended use: TRIATHLON

Weight: 233g

3D Air mesh: tomaia estremamente traspirante e leggera

Fast Transitions: strap in velcro sul collo del piede per transizioni rapide

R5 Nylon Outsole: posizionamento ottimizzato delle tacchette con un indice di rigidità moderato

3D Air mesh : tige extrêmement respirante et légère

Fast Transitions : bande velcro sur le cou-de-pied pour une transition rapide

R5 Nylon Outsole : positionnement optimisé des crampons avec un indice de rigidité modéré



ARTICLE	EAN	MODEL	COLOR	SIZE	OUTSOLE	CLOSURE	UPPER	SRP (€)
TRR5PMR1K2010	Various	Transiro Hydra	White/Black	36-48	R5 nylon	Instep Velcro Strap	3D Air Mesh	149
TRR5PMR1K20MR	Various		White/Metallic Red					149
TRR5PMR1K20MB	Various		White/Metallic Blue					149

OFF-ROAD SHOES





VENTO
FEROX
CARBON

Intended use: CROSS-COUNTRY / GRAVEL RACING

Weight: 300g

PU Laminated Mesh Upper: leggera e traspirante con una costruzione a prova di strappo

Powerstrap & BOA® Fit System: doppio sistema di chiusura dove il collo e la pianta del piede sono regolabili separatamente per una calzata personalizzata e sicura

X1 Carbon & Rubber Outsole: suola full carbon, elevata rigidità e leggerezza calibrate per il trasferimento di potenza e una trazione eccellente quando si è a piedi

PU Laminated Mesh Upper : légère et respirante donnant une construction indéchirable

Powerstrap & BOA® Fit System : système de double fermeture où le cou-de-pied et le milieu du pied sont réglables séparément permettant un ajustement personnalisé et sécurisé

X1 Carbon & Rubber Outsole : semelle entièrement en carbone, haute rigidité et légèreté pour un transfert de puissance et une excellente traction à pied



new colour



new colour



ARTICLE	EAN	NEW	MODEL	COLOR	SIZE	OUTSOLE	CLOSURE	UPPER	SRP (€)
VEX1WMR1C1010	Various			Black/Black					299
VEX1WMR1C3820	Various		Vento	Lilac/White**	36-48*	Full Carbon Unidirectional, Rubber Treads	Li2 BOA® Fit System + Velcro Strap	PU Laminated Mesh	299
VEX1WMR1C8598	Various	new	Ferox	Mud/Grape					299
VEX1WMR1C5C35	Various	new		Lime/Purple					299

Tutti i modelli sono disponibili nelle taglie piene | Tous les modèles sont disponibles en tailles pleines

(*) Modello disponibile anche nelle taglie: **42½, 43½, 44½** | Egalement disponible dans les tailles: **42½, 43½, 44½**

(**) Fino ad esaurimento scorte | Jusqu'à épuisement des stocks

**VENTO
PROXY**

Intended use: XC, CX, GRAVEL

Weight: 325g

PU Laminated Mesh Upper: leggera e traspirante con una costruzione antistrappo

Pratico sistema di chiusura singola BOA®

X3 Fiber Composite & Rubber Outsole: elevata rigidità per un efficiente trasferimento di potenza e comfort

PU Laminated Mesh Upper : légère et respirante dans une construction résistante à la déchirure

Système de fermeture BOA® simple pratique

X3 Fiber Composite & Rubber Outsole : grande rigidité pour un transfert de puissance efficace et confortable



new colour



ARTICLE	EAN	NEW	MODEL	COLOR	SIZE	OUTSOLE	CLOSURE	UPPER	SRP (€)
VEX3BPR1V1010	Various			Black/Black	36-48*				229
VEX3BPR1V9635	Various		Vento	Coral/Purple**	36-48*	X3 Carbon	1x BOA® Li2	PU Laminated	229
VEX3BPR1V2020	Various		Proxy	White/White	36-48*	Reinforced Nylon and Rubber Outsole	Fit System	Mesh	229
VEX3BPR1K3E5C	Various	new		Light Lilac/Lime	36-48*				229

Tutti i modelli sono disponibili nelle taglie piene | Tous les modèles sont disponibles en tailles pleines

(*) Modello disponibile anche nelle taglie: **42½, 43½, 44½** | Egalement disponible dans les tailles: **42½, 43½, 44½**

(**) Fino ad esaurimento scorte | Jusqu'à épuisement des stocks

TERRA ATLAS

Intended use: CROSS-COUNTRY / GRAVEL /
DOWN-COUNTRY

Weight: 355g

The All Terrain, All-Rounder: si adattano a una vasta gamma di stili di guida, dall' all-mountain al cross country e al gravel

All-Day Comfort: vestibilità generosa, con un pratico sistema di chiusura con singolo rotore BOA®

X5 Nylon & Rubber Outsole: assicura efficienza di pedalata assieme a una trazione in fuoristrada affidabile e sicura

The All Terrain, All-Rounder: convient à un large éventail de styles de conduite, du all-mountain au crosscountry en passant par le gravel

All-Day Comfort: coupe généreuse, avec un système de fermeture simple BOA pratique

X5 Nylon & Rubber Outsole : offre une efficacité de pédalage ainsi qu'une traction tout-terrain rassurant et sûre



ARTICLE	EAN	MODEL	COLOR	SIZE	OUTSOLE	CLOSURE	UPPER	SRP (€)
TEX5BPR1K7010	Various		Grey/Black					159
TEX5BPR1K1010	Various	Terra Atlas	Black/Black	36-48	Nylon, Rubber Treads	L6 BOA® Fit System	Tear Resistant High Density PU	159
TEX5BPR1K6110	Various		Army					159
TEX5BPR1K3710	Various		Pink Grape**					159

(**) Fino ad esaurimento scorte | Jusqu'à épuisement des stocks

TERRA

POWERSTRAP X4

Intended use: GRAVEL

Weight: 292g

Powerstrap: chiusura con Velcro che avvolge il piede.

Disegnata per una calzata avvolgente

X4 Outsole: rigidità calibrata e gomma del battistrada adatta per le superfici miste

Powerstrap : fermeture enveloppante du pied par velcro conçue pour un ajustement parfait

X4 Outsole : rigidité calibrée et caoutchouc de semelle externe adapté aux surfaces mixtes



ARTICLE	EAN	MODEL	COLOR	SIZE	OUTSOLE	CLOSURE	UPPER	SRP (€)
TEX4PPR1K8586	Various	Terra	Mud/Caramel**	36-48	Fiber Reinforced Nylon, Rubber Tread	Foot-wrapping Velcro	PU	159
TEX4PPR1K1010	Various	Powerstrap X4	Black/Black**					159

(**) Fino ad esaurimento scorte | Jusqu'à épuisement des stocks

TERRA
ERGOLACE X2 GTX

Intended use: TRAIL, GRAVEL, BIKEPACKING

Weight: 389g

GORE-TEX PRISM 3L Membrane: protezione impermeabile e traspirante a triplo strato

Ready for every adventure: scelta ideale per lunghe avventure in cui il comfort prolungato, giorno dopo giorno, è fondamentale. Progettata per essere adattabile, passando facilmente da strade gravel a singletrack e viceversa

Ergolace: allacciatura ergonomica per una fit anatomico

X2 Outsole: Vibram XS Trek Evo per una trazione sia in sella sia a piedi

GORE-TEX PRISM 3L Membrane : protection imperméable respirante à trois couches
 Ready for every adventure : le choix idéal pour les aventures prolongées où le confort jour après jour est essentiel. Conçue pour être adaptable, elle passe facilement des routes de gravel aux singletrack et vice-versa.

Ergolace : fermeture à lacets ergonomique pour un ajustement anatomique

X2 Outsole : vibram xs trek evo pour l'adhérence, sur et en dehors du vélo



ARTICLE	EAN	MODEL	COLOR	SIZE	OUTSOLE	CLOSURE	UPPER	SRP (€)
TEX2EGR1V1410	Various	Terra Ergolace	Ice Grey/Black	36-48	X2 Outsole – Nylon Shank,	Ergolace	Ripstop Fabric	189
TEX2EGR1V1210	Various	X2 GTX	Anthracite/Black	36-48	EVA Midsole and Vibram Tread	Lace-up Pattern	with GTX Membrane	189

TERRA
ERGOLACE X2

Intended use: TRAIL, GRAVEL, BIKE PACKING

Weight: 329g

Ergolace: chiusura a lacci ergonomica per una calzata anatomica

Ripstop fabric: tessuto resistente allo strappo e alla lacerazione

X2 Outsole: in gomma Vibram per la trazione sui pedali e a piedi

Ergolace : fermeture à laçage ergonomique pour un ajustement anatomique

Ripstop fabric : tissu résistant à l'abrasion et à la déchirure

X2 Outsole : en caoutchouc Vibram pour une meilleure adhérence sur les pédales et dans les parties pédestres



Black/Black

Available also in FLAT VERSION



FLAT VERSION Weight: 303g



ARTICLE	EAN	MODEL	COLOR	SIZE	OUTSOLE	CLOSURE	UPPER	SRP (€)
TEX2ETR1K1010	Various	Terra Ergolace X2	Black/Black**	36-48	Nylon Shank, EVA Midsole, Vibram Tread	Laces	Ripstop Fabric	129
TEX2ETR1K5886	Various		Olive/Caramel**					129
TEX2ETF1K1010	Various	Terra Ergolace X2 Flat	Black/Black**	36-48	EVA Midsole, Vibram Megagrip Tread	Laces	Ripstop Fabric	129

(**) Fino ad esaurimento scorte | Jusqu'à épuisement des stocks

GRAVITA TENSOR

Intended use: DH, ENDURO

Weight: 410g

Clip-In Gravita Outsole: mescola Vibram XS Trek Evo e tassellatura sviluppata per l'aderenza con il pedale e il controllo della bici

Tensor: calzata precisa e aderenza sul piede per le prestazioni

Injection Moulded TPU Armoured Toe-Box: protezione solida del piede durante le discese più tecniche

Ripstop Fabric: tessuto resistente allo strappo e alla lacerazione

Clip-In Gravita Outsole : Composition Vibram XS Trek Evo développée pour l'adhérence avec la pédale et le contrôle du vélo

Tensor : ajustement précis et adhérence au pied pour la performance

Injection Moulded TPU Armoured Toe-Box : protection solide du pied lors de randos sur terrain boueux

Ripstop Fabric : tissu résistant à l'abrasion et à la déchirure



Available also in FLAT VERSION



FLAT VERSION Weight: 310g



ARTICLE	EAN	MODEL	COLOR	SIZE	OUTSOLE	CLOSURE	UPPER	SRP (€)
GRX6TTC1C1010	Various	Gravita Tensor	Black/Black	36-48	Nylon Shank, EVA Midsole, Vibram Xs Trek EVO Tread	Laces + Instep Velcro	Ripstop Fabric + TPU Reinforcements	179
GRX6TTF1C1010	Various	Gravita Tensor Flat	Black/Black	36-48	EVA Midsole, Vibram Megagrip Tread	Laces + Instep Velcro	Ripstop Fabric + TPU Reinforcements	179

**GRAVITA
VECTOR**

Intended use: DH, ENDURO

Weight: 355g

Clip-In Gravita Outsole: mescola Vibram XS Trek Evo e tassellatura sviluppata per l'aderenza con il pedale e il controllo della bici

Ergolace: chiusura a lacci ergonomica per una calzata anatomica

Ripstop Fabric: tessuto resistente allo strappo e alla lacerazione

Clip-In Gravita Outsole : Composition Vibram XS Trek Evo développée pour l'adhérence avec la pédale et le contrôle du vélo

Ergolace : fermeture à laçage ergonomique pour un ajustement anatomique

Ripstop Fabric : tissu résistant à l'abrasion et à la déchirure



Available also in FLAT VERSION



FLAT VERSION Weight: 270g



ARTICLE	EAN	MODEL	COLOR	SIZE	OUTSOLE	CLOSURE	UPPER	SRP (€)
GRX6VTC1K7085	Various	Gravita Vector	Grey/Mud	36-48	Nylon Shank, EVA Midsole, Vibram Xs Trek EVO Tread	Laces	Ripstop Fabric	139
GRX6VTF1K7085	Various	Gravita Vector Flat	Grey/Mud	36-48	EVA Midsole, Vibram Megagrip Tread	Laces	Ripstop Fabric	139

TERRA
ARTICA X5 GTX

Intended use: GRAVEL, MTB

Weight: 432g

GORE-TEX Koala Membrane: isolata, impermeabile e traspirante, la membrana Koala di GORE-TEX ti mantiene caldo e asciutto durante le rigide giornate invernali

Fleeced Lining: la morbida fodera in pile spazzolato aggiunge isolamento e comfort alle tue uscite anche nei giorni più freddi

All-Day Comfort: vestibilità generosa e regolazioni facili grazie al pratico BOA® Fit System a rotella singola e allo strap in velcro

X5 Nylon & Rubber Outsole: assicura efficienza di pedalata assieme a una trazione in fuoristrada affidabile e sicura



GORE-TEX Koala Membrane : isolante, imperméable et respirante, la membrane Koala de GORE-TEX vous garde au chaud et au sec dans les conditions de sortie hivernales les plus difficiles

Fleeced Lining : La doublure douce en polaire brossée ajoute de l'isolation et du confort lors des sorties hivernales les plus froides

All-Day Comfort : La coupe généreuse et les ajustements faciles sont fournis par un système d'ajustement pratique à cadran unique

BOA® et une sangle sécurisée en Velcro

X5 Nylon & Rubber Outsole : offre une efficacité de pédalage ainsi qu'une traction tout-terrain rassurant et sûre



ARTICLE	EAN	MODEL	COLOR	SIZE	OUTSOLE	CLOSURE	UPPER	SRP (€)
TER5AGR1V1010	Various	Terra Artica X5 GTX	Black/Black	40-48	X5 Nylon Outsole with Rubber Treads	1x BOA® L6 dial & Ankle Velcro Strap	High-density PU Upper + GORE-TEX Membrane	269
TER5AGR1V3510	Various		Purple/Black**					269

(**) Fino ad esaurimento scorte | Jusqu'à épuisement des stocks

PERFORMANCE CYCLING SOCKS

Intended use: ROAD

I nostri calzini da ciclismo ad alte prestazioni, realizzati in maglia con filato antibatterico Q-Skin® per un comfort traspirante e che assorbe l'umidità durante ogni ride.

- Filato Q-Skin®: altamente assorbente con proprietà antimicrobiche
- Zone in spugna nell'area delle tacchette: evita punti di pressione
- Costruzione sottile e leggera per migliorare la traspirabilità

Nos chaussettes performantes pour le cyclisme sur route, tricotées à partir du fil Q-Skin® anti-microbien pour un confort respirant et évacuant l'humidité à chaque sortie.

- Q-Skin® : haute capacité d'évacuation de l'humidité et propriétés anti-microbiennes
- Zones en tissu éponge sur les cales : évite les points de pression
- Construction fine et légère pour améliorer la respirabilité



TEAM EDITION CYCLING SOCKS

Intended use: OFF-ROAD, ROAD RACING

Calzini da ciclismo colorati e con design deciso progettati per mantenere i piedi asciutti e in movimento, dando al team fizik comfort e stile.

- Filato Techno PE: altamente assorbente con proprietà antimicrobiche
- Zone in spugna nell'area delle tacchette e sull'arcata plantare: evita punti di pressione
- Tallone e punta più spessi per migliorare il comfort
- Costruzione a coste sulla gamba

Chaussettes de cyclisme colorées et audacieuses conçues pour garder les pieds au sec et rouler en représentant l'équipe Fizik dans le confort et le style.

- Fil Techno PE : haute capacité d'évacuation de l'humidité et propriétés anti-microbiennes
- Zones en tissu éponge sur les cales et le cou-de-pied : évite les points de pression
- Talon et avant pied plus épais pour améliorer le confort
- Construction en côtes sur la jambe



OFF-ROAD CYCLING SOCKS

Intended use: OFF-ROAD

Calzini da ciclismo off-road comodi e resistenti, progettati per offrire una migliore traspirabilità e supporto duraturo durante grandi avventure lontano dall'asfalto.

- Filato Techno PE: altamente assorbente con proprietà antimicrobiche
- Zone in spugna nella zona delle tacchette e sull'arcata plantare: evita punti di pressione
- Tallone e punta più spessi per migliorare il comfort
- Costruzione a coste sulla gamba

Chaussettes de cyclisme tout-terrain confortables et résistantes, conçues pour offrir une meilleure respirabilité et un soutien durable lors des grandes aventures hors du bitume.

- Fil Techno PE : haute capacité d'évacuation de l'humidité et propriétés anti-microbiennes
- Zones en tissu éponge sur les cales et le cou-de-pied : évite les points de pression
- Talon et avant pied plus épais pour améliorer le confort
- Construction en côtes sur la jambe



ARTICLE	EAN	MODEL	COLOR	SIZE	MATERIAL	SRP (€)
FZKSOCKSRO1000	Various	Performance Cycling Socks	Black	S (35-39) M (40-43) L (44-47)	QSkin Yarn	18,90
FZKSOCKSRO2000	Various		White	S (35-39) M (40-43) L (44-47)		18,90
FZKSOCKSTE382000	Various	Team Edition Cycling Socks	Lilac-White	S (35-39) M (40-43) L (44-47)	Techno PE Yarn	18,90
FZKSOCKSOF7010	Various	Off-Road Cycling Socks	Grey-Black	S (35-39) M (40-43) L (44-47)	Techno PE Yarn	18,90

SHOES ACCESSORIES & PARTS

ARTICLE	EAN	MODEL	COLOR	SIZE	DESCRIPTION	SRP (€)
COVER						
FZTCW1000	-	Windproof Toe Cover	Black	XS (36-40) M (41-44) XL (45-48)	PU Cloth Main Fabric, Microfiber Toe Cap & Puller, Bottom PU Reinforced	25
FZSCWP109400	-	Waterproof Winter Overshoe	Black/ Reflective	S (36-39) M (40-43) L (44-46) XL (47-48)	WP and Windproof Upper, Rubberized Bottom for Better Grip, Reflective logo and Piping	59
KIT BOA® SHOES						
12002641000U	8058364168937	LI2 Dial C KIT left and right	Black	-	1 BOA® left + 1 BOA® right compatible with Vento Omna	37,50
12002572000U	8058364161334	LI2 Dial B KIT left and right	White	-	1 BOA® left + 1 BOA® right compatible with Stabilita Carbon	37,50
12002621000U	8058364161327	LI2 Dial B KIT left and right	Black	-	1 BOA® left + 1 BOA® right compatible with new Vento Infinito Carbon, Vento Infinito Knit Carbon and Stabilita Carbon, Vento Ferox Carbon, Tempo Decos Carbon	37,50
12002562000U	8058364161310	LI2 Dial A KIT left and right	White	-	1 BOA® left + 1 BOA® right compatible with Tempo Decos Carbon	37,50
12002601000U	8058364161341	IP1 KIT left and right	Black	-	1 BOA® left + 1 BOA® right compatible with all fi'zi:k R1M-BC, INFINITO R1, ARIA R3, OVERCURVE R4, OVERCURVE R5, TRIATHLON TRANSIRO R1 and R3 shoes, M3B (model from ss 2017 to 2018), M4B (model 2018), INFINITO X1 and VENTO OVERCURVE X3	25
12002592000U	8058364161358	IP1 KIT left and right	White/ Transparent	-	1 BOA® left + 1 BOA® right compatible with all fi'zi:k R1M-BC, INFINITO R1, ARIA R3, OVERCURVE R4, OVERCURVE R5, TRIATHLON TRANSIRO R1 and R3 shoes, M3B (model from ss 2017 to 2018), M4B (model 2018), INFINITO X1 and VENTO OVERCURVE X3	25
12002611000U	8058364161365	L6 KIT dial D left and right	Black	-	1 BOA® left + 1 BOA® right compatible with all fi'zi:k M4B (model 2017), TERRA X5 (model 2018) and M6B (model from 2017 to current), TERRA CLIMA X2, TERRA ARTICA X2, Terra Artica GTX and Tempo Artica GTX	19
12002551000U	8058364161303	LI2 Dial A KIT left and right	Black	-	1 BOA® left + 1 BOA® right compatible with Vento Ferox Carbon and Tempo Decos Carbon	37,50
12002631000U	8058364161389	L6 dial K KIT left and right W CS1	Black	-	1 BOA® left + 1 BOA® right compatible with all Terra Atlas shoes	19
12002582000U	8058364161372	L6 KIT dial D left and right	White	-	1 BOA® left + 1 BOA® right compatible with Tempo Artica GTX	19
TOE STUDS KIT						
KTOESTUD101000U	8058364147420	Toe Studs Kit	Black	-	Toe Studs Kit - Vento Ferox Carbon & Terra Atlas (pair)	7,99
KTOESTUD5B5B00U	8058364149127		Mint	-	Toe Studs Kit - Vento Ferox Carbon (pair)	7,99
KTOESTUD909000U	8058364149134		Yellow Fluo	-	Toe Studs Kit - Vento Ferox Carbon (pair)	7,99
SHOES SPARE PARTS						
FZHSPR1C1000	-	Heel Skid Plate		S-L	Heel Skid Plate (pair) R1B shoes	15
FZHSPR3C1000	-		Black	S-M-L	Heel Skid Plate (pair) R3B shoes	13
KHPVER21C1000	-			S-L	Heel Skid Plate Vento R2	15



HELMETS





KUDO new HELMET

Intended use: ROAD, XC, GRAVEL

Weight: 280g

MIPS Air Node

EPS: Poly Source - American Made

SHELL: PC

ROLL FIT: Property - Designed by Fizik

CFD & Wind Tunnel Tests

Kudo è il casco più leggero ed aerato della gamma fizik, ideale per affrontare lunghe salite di montagna o intense gare off-road.

La regolazione occipitale e frontale permette una calzata personalizzata senza precedenti, aumentando il comfort e la stabilità del casco.

L'imbottitura è sottile e leggera per migliorare la termoregolazione, mentre il sistema MIPS Air Node integrato aiuta a dissipare le forze rotazionali senza compromettere la ventilazione.

Il casco è dotato di luce posteriore removibile per migliorare la visibilità del ciclista in ogni momento della giornata.

Kudo est le casque le plus léger et le mieux ventilé de la gamme fizik, idéal pour affronter de longues montées en montagne ou des courses intenses tout-terrain.

La réglage occipitale et frontale permet un ajustement personnalisé sans précédent, augmentant le confort et la stabilité du casque.

Le rembourrage est fin et léger pour améliorer la thermorégulation, tandis que le système MIPS Air Node intégré aide à dissiper les forces rotationnelles sans compromettre la ventilation.

Le casque est équipé d'une lumière arrière amovible pour améliorer la visibilité du cycliste à tout moment de la journée.



ARTICLE	EAN	NEW	MODEL	COLOR	SIZE	SRP (€)
FHE000001002000S	8021890618900	new	Kudo	White	S	290
FHE000001002000M	8021890618917	new		White	M	290
FHE000001002000L	8021890618924	new		White	L	290
FHE000001001000S	8021890618931	new		Black	S	290
FHE000001001000M	8021890618948	new		Black	M	290
FHE000001001000L	8021890618955	new		Black	L	290
FHE000001003D00S	8021890618962	new		Bronze	S	290
FHE000001003D00M	8021890618979	new		Bronze	M	290
FHE000001003D00L	8021890618986	new		Bronze	L	290

KUDO AERO HELMET new

Intended use: ROAD, XC, GRAVEL

Weight: 290g

MIPS Air Node

EPS: Poly Source - American Made

SHELL: PC

ROLL FIT: Property - Designed by Fizik

CFD & Wind Tunnel Tested

Kudo Aero è un casco aerodinamico e leggero sviluppato in galleria del vento, la cui calotta integrata e lo spoiler posteriore aumentano l'efficienza aerodinamica.

Le aperture nella zona frontale e il grande diffusore posteriore permettono all'aria calda di uscire migliorando la termoregolazione.

L'imbottitura è sottile e leggera per migliorare la termoregolazione, mentre il sistema MIPS Air Node integrato aiuta a dissipare le forze rotazionali senza compromettere la ventilazione.

Il casco è dotato di luce posteriore removibile per migliorare la visibilità del ciclista in ogni momento della giornata.

Développé en soufflerie, Kudo Aero est un casque aérodynamique et léger avec une coque intégrée et un spoiler arrière pour augmenter l'efficacité aérodynamique.

Les ouvertures à l'avant et le grand diffuseur arrière permettent à l'air chaud de s'échapper, améliorant ainsi la thermorégulation.

La réglage occipitale et frontale permet un ajustement personnalisé sans précédent, augmentant le confort et la stabilité du casque.

Le rembourrage est fin et léger pour améliorer la thermorégulation, tandis que le système MIPS Air Node intégré aide à dissiper les forces rotationnelles sans compromettre la ventilation.

Le casque est équipé d'une lumière arrière amovible pour améliorer la visibilité du cycliste à tout moment de la journée.



ARTICLE	EAN	NEW	MODEL	COLOR	SIZE	SRP (€)
FHE000002002000S	8021890618993	new	Kudo Aero	White	S	290
FHE000002002000M	8021890619006	new		White	M	290
FHE000002002000L	8021890619013	new		White	L	290
FHE000002001000S	8021890619020	new		Black	S	290
FHE000002001000M	8021890619037	new		Black	M	290
FHE000002001000L	8021890619044	new		Black	L	290
FHE000002008000S	8021890619051	new		Silver	S	290
FHE000002008000M	8021890619068	new		Silver	M	290
FHE000002008000L	8021890619075	new		Silver	L	290

KASSIS new HELMET

Intended use: MTB

Weight: 360g

MIPS Air Node

EPS: Poly Source - American Made

SHELL: PC

ROLL FIT: Property - Designed by Fizik

Il casco Kassis è la scelta ideale per le avventure in MTB ed e-bike, offre una ventilazione eccezionale ed una protezione maggiore nella zona occipitale e laterale. La regolazione occipitale e frontale permette una calzata personalizzata senza precedenti, aumentando il comfort e la stabilità del casco.

L'imbottitura è sottile e leggera per migliorare la termoregolazione, mentre il sistema MIPS Air Node integrato aiuta a dissipare le forze rotazionali senza compromettere la ventilazione.

Il casco è dotato di luce posteriore removibile per migliorare la visibilità del ciclista in ogni momento della giornata.

Le casque Kassis est le choix idéal pour les aventures en VTT et en vélo électrique, offrant une ventilation exceptionnelle et une protection accrue dans les zones occipitale et latérale.

La réglage occipitale et frontale permet un ajustement personnalisé sans précédent, augmentant le confort et la stabilité du casque.

Le rembourrage est fin et léger pour améliorer la thermorégulation, tandis que le système MIPS Air Node intégré aide à dissiper les forces rotationnelles sans compromettre la ventilation.

Le casque est équipé d'une lumière arrière amovible pour améliorer la visibilité du cycliste à tout moment de la journée.



ARTICLE	EAN	NEW	MODEL	COLOR	SIZE	SRP (€)
FHE000004002000S	8021890619105	new	Kassis	White	S	200
FHE000004002000M	8021890619112	new		White	M	200
FHE000004002000L	8021890619129	new		White	L	200
FHE000004004B00S	8021890619136	new		Dark Navy	S	200
FHE000004004B00M	8021890619143	new		Dark Navy	M	200
FHE000004004B00L	8021890619150	new		Dark Navy	L	200
FHE000004853C00S	8021890619167	new		Mud/Sand	S	200
FHE000004853C00M	8021890619174	new		Mud/Sand	M	200
FHE000004853C00L	8021890619181	new		Mud/Sand	L	200

KUNÈE new HELMET

Intended use: TRIATHLON / TIME TRIAL

Weight: 330g (without visor)

EPS: Poly Source - American Made

SHELL: PC

ROLL FIT: Property - Designed by Fizik

CFD & Wind Tunnel Tested

Kunèe è il casco più aerodinamico della gamma fizik, pensato per eccellere nelle gare a cronometro e triathlon.

Grazie a studi in galleria del vento e test di fluidodinamica computazionale, sono stati adottati forme e componenti che migliorano il flusso d'aria intorno al casco.

L'efficienza aerodinamica risulta ottimale nelle posizioni in sella più performanti.

Il casco viene fornito con due visiere magnetiche removibili, specchiata e trasparente.

La regolazione occipitale permette di personalizzare la calzata, aumentando il comfort e la stabilità del casco.

L'imbottitura sottile e leggera e i fori di ventilazione migliorano la termoregolazione e il flusso d'aria interno.

Kunèe est le casque le plus aérodynamique de la gamme fizik, conçu pour exceller dans les contre-la-montre et les triathlons.

Grâce aux études en soufflerie et aux tests de dynamique des fluides computationnelle, des formes et des composants ont été adoptés pour améliorer le flux d'air autour du casque.

L'efficacité aérodynamique est optimale dans les positions en selle les plus performantes.

Le casque est fourni avec deux visières magnétiques amovibles, une miroir et une transparente.

La réglage occipitale permet de personnaliser l'ajustement, augmentant le confort et la stabilité.

Le rembourrage fin et léger et les orifices de ventilation améliorent la thermorégulation et le flux d'air interne.



ARTICLE	EAN	NEW	MODEL	COLOR	SIZE	SRP (€)
FHE0000300200SM	8021890619082	new	Kunèe	White	S, M	380
FHE0000300200ML	8021890619099	new		White	M, L	380

ACCESSORIES						
ARTICLE	EAN	NEW	MODEL	DESCRIPTION		SRP (€)
FHL0000A00000	8021890619815	new	Fizik Helmet Light	-		29

BARTAPES & GRIPS





TOUCH



TACKY

2mm / 2,7mm / 3,5mm

Finitura che offre una superficie ad alta aderenza e antiscivolo per un grip superiore in ogni condizione.

Finition qui présente une surface confortable et antidérapante pour une adhérence supérieure dans toutes les conditions.



CLASSIC

2mm / 3mm

Una texture durevole e traforata come la pelle, con un look tradizionale e una superficie liscia che agevola le transizioni tra le diverse posizioni di guida.

Une texture durable similaire à du cuir perforé, avec une esthétique traditionnelle et une surface lisse qui permet de glisser facilement par rapport à différentes positions de conduite.



SOFT

3mm

Una superficie dal look opaco e con finitura setosa, che assorbe l'umidità.

Une surface soyeuse, absorbant l'humidité, avec un aspect mat.

CONSTRUCTION

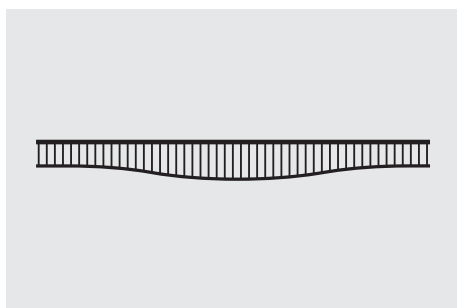

MICROTEX

2mm

La più sottile delle opzioni per una presa estremamente precisa e per il controllo.

La plus précise des options pour une adhérence et un contrôle précis.

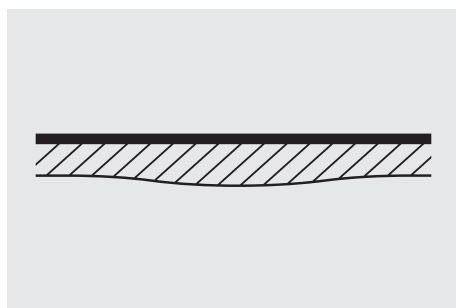

SOLOCUSH

2,7mm / 3,5mm

La nostra costruzione più filante e ammortizzata, una piattaforma imbottita monostrato su cui fare affidamento durante le uscite più lunghe senza scendere a compromessi con il peso.

Notre fabrication la plus profilée et la plus rembourrée, une plate-forme monocouche sur laquelle vous pouvez compter sur vos plus longues sorties, sans jamais compromettre le poids.

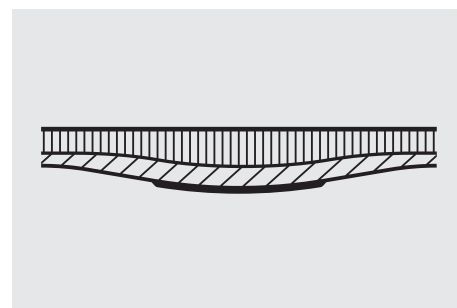

BONDCUSH

3mm

Una schiuma polimerica stratificata di media imbottitura che assorbe i microcolpi trasmessi dall'asfalto. Assieme allo strato esterno in Microtex, questo mix di materiali è la nostra opzione più valida per avere comfort, versatilità e durata.

Un rembourrage de mousse polymère stratifié qui absorbe les micro-coups transmis par l'asphalte. Avec la couche extérieure en Microtex, ce mélange de matériaux est notre meilleure option pour le confort, la polyvalence et la durabilité.

VENTO

MICROTEX TACKY

Intended use: ROAD RACING

Nastro manubrio da corsa in microtex, dello spessore di 2 mm. Alta aderenza al tatto per una presa ottimale in ogni condizione.

Guidoline de course en microtex, 2 mm d'épaisseur. Toucher collant pour une adhérence ultime dans toutes les conditions.



ARTICLE	EAN	MODEL	COLOR	CONSTRUCTION	TOUCH	THICKNESS	SRP (€)
BT09000A00042	8021890466457		Black				39,90
BT09000A00044	8021890466464		White				39,90
BT09000A00012	8021890466440		Red				39,90
BT09000A00047	8021890466488		Orange Fluo				39,90
BT09000A00050	8021890466495		Pink Fluo				39,90
BT09000A00046	8021890466471	Vento Microtex Tacky	Yellow Fluo	Microtex	Tacky	2mm	39,90
BT09000A00051	8021890466501		Lilla Fluo				39,90
BT09000A00009	8021890466433		Celeste				39,90
BT15000A20042	8021890482693		Black/Celeste				44,90
BT15000A40042	8021890482716		Black/White				44,90
BT15000A50042	8021890482723		Black/Red				44,90
BT15000A60042	8021890482730		Black/Grey				44,90

VENTO
SOLOCUSH TACKY

Intended use: ROAD RACING

Nastro manubrio pro realizzato in Solocush, dello spessore di 2,7 mm, alta aderenza al tatto.

Guidoline professionnelle en Solocush, 2,7 mm d'épaisseur, toucher collant.



ARTICLE	EAN	MODEL	COLOR	CONSTRUCTION	TOUCH	THICKNESS	SRP (€)
BT11000A00042	8021890466686		Black				44,90
BT11000A00044	8021890466693		White				44,90
BT11000A00055	8021890467034		Blue				44,90
BT11000A00025	8021890466679		Green				44,90
BT11000A00012	8021890466655		Red				44,90
BT11000A00011	8021890466648		Pink				44,90
BT11000A00014	8021890466662		Yellow				44,90
BT11000A00047	8021890466716	Vento Solocush Tacky	Orange Fluo	Solocush	Tacky	2,7mm	44,90
BT11000A00050	8021890466723		Pink Fluo				44,90
BT11000A00046	8021890466709		Yellow Fluo				44,90
BT11000A00051	8021890466730		Lilla Fluo				44,90
BT11000A00009	8021890466631		Celeste				44,90
BT11000A00057	8021890498885		Light Grey				44,90
BT11000A00058	8021890498892		Dark Grey				44,90
BT11000A00059	8021890498908		Mint Green				44,90

TEMPO

MICROTEX CLASSIC

Intended use: ROAD

Nastro manubrio performance realizzato in microtex, dello spessore di 2 mm, aderenza classica al tatto.

Une guidoline performante en microtex, 2 mm d'épaisseur, toucher classique.



ARTICLE	EAN	MODEL	COLOR	CONSTRUCTION	TOUCH	THICKNESS	SRP (€)
BT10000A00032	8021890466600	Tempo Microtex Classic	Black	Microtex	Classic	2mm	19,90
BT10000A00010	8021890466549		White				19,90
BT10000A00055	8021890467027		Blue				19,90
BT10000A00025	8021890466594		Green				19,90
BT10000A00012	8021890466563		Red				19,90
BT10000A00011	8021890466556		Pink				19,90
BT10000A00014	8021890466570		Yellow				19,90
BT10000A00045	8021890466617		Orange				19,90
BT10000A00018	8021890466587		Honey				19,90
BT10000A00006	8021890466525		Silver				19,90
BT10000A00009	8021890466532		Celeste				19,90

TEMPO

BOND CUSH CLASSIC

Intended use: ROAD

Nastro manubrio per ciclismo realizzato in Bondcush, una schiuma polimerica di imbottitura media per smorzare le vibrazioni della strada. Aderenza classica al tatto in una texture resistente, perforata e simile alla pelle. 3 mm di spessore.

Guidoline fabriquée à partir de Bondcush, une mousse polymère qui aide à absorber les aspérités de la route. Toucher classique dans une texture durable, perforée, semblable au cuir. 3 mm d'épaisseur



TEMPO

BOND CUSH SOFT

Intended use: ROAD

Nastro manubrio per bici da strada realizzato in Bondcush, dello spessore di 3 mm, con un aspetto matt, setoso e morbido al tatto, con una superficie che assorbe l'umidità.

Guidoline fabriquée à partir de Bondcush, 3mm d'épaisseur, d'aspect mat et soyeux, au toucher doux, avec une surface absorbant l'humidité.



ARTICLE	EAN	MODEL	COLOR	CONSTRUCTION	TOUCH	THICKNESS	SRP (€)
BT13000A00032	8021890466891	Tempo Bondcush Classic	Black	Bondcush	Classic	3mm	24,90
BT13000A00010	8021890466839		White				24,90
BT13000A00018	8021890466877		Honey				24,90
BT14000A00002	8021890466914	Tempo Bondcush Soft	Black	Bondcush	Soft	3mm	29,90
BT14000A00012	8021890466969		Red				29,90

TERRA

SOLOCUSH TACKY new

Intended use: GRAVEL

Nastro manubrio pensato per il gravel, dove comfort e grip sono fondamentali. La nostra costruzione Solocush è leggera e morbida, con uno spessore aumentato a 3.5mm ideale durante le uscite più lunghe ma senza mai scendere a compromessi con il peso. La finitura Tacky produce una superficie aderente e antiscivolo con una struttura in rilievo per una presa superiore in ogni condizione.

Guidoline conçue pour le gravel, où le confort et l'adhérence sont essentiels. Notre construction Solocush est légère et souple, avec une épaisseur accrue de 3,5 mm idéale pour les longues sorties sans jamais compromettre le poids. La finition Tacky produit une surface collante et antidérapante avec une structure texturée pour une adhérence supérieure dans toutes les conditions.



ARTICLE	EAN	NEW	MODEL	COLOR	CONSTRUCTION	TOUCH	THICKNESS	SRP (€)
BT17000A00057	8021890619198	new	Terra Solocush Tacky	Light Grey	Solocush Tacky	Tacky	3,5mm	44,90
BT17000A00002	8021890619204	new		Black				44,90
BT17000A00016	8021890619211	new		White				44,90
BT17000A00012	8021890619228	new		Red				44,90
BT17000A00052	8021890619235	new		Dark Blue				44,90
BT17000A00053	8021890619242	new		Green / Blue				44,90
BT17000A00054	8021890619259	new		Brown				44,90

VENTO

MICROTEX TACKY 2mm BOX 10 KITS (20 ROLLS)

1 kit contiene:

- 2 rotoli di nastro Vento Microtex Tacky 2mm nero
- 2 strisce di nastro extra
- 2 tappi manubrio
- 2 nastri di finitura

1 kit contient :

- 2 rouleaux de ruban adhésif noir Vento Microtex Tacky 2mm
- 2 bandes de ruban adhésif supplémentaires
- 2 bouchons de cintre
- 2 rubans de finition



TEMPO

BONDCUSH SOFT 3mm BOX 10 KITS (20 ROLLS)

1 kit contiene:

- 2 rotoli di nastro Tempo Bondcush 3mm Soft nero
- 2 strisce di nastro extra
- 2 tappi manubrio
- 2 nastri di finitura

1 kit contient :

- 2 rouleaux de ruban adhésif noir souple Tempo Bondcush 3mm
- 2 bandes de ruban adhésif supplémentaires
- 2 bouchons de cintre
- 2 rubans de finition



BAR GEL KIT

- 2 strisce di gel curve tagliate su misura
- 2 strisce di gel retilinee tagliate su misura
- 2 strisce di chiusura superiori

- 2 pièces de gel cintrées ajustables à la dimension souhaitée
- 2 pièces de gel droites ajustables à la dimension souhaitée
- 2 bandes adhésives pour les extrémités



ARTICLE	EAN	MODEL	COLOR	CONSTRUCTION	TOUCH	THICKNESS	SRP (€)
FZKTAPE000000	8021890579638	Vento Microtex Tacky 10 Kits (20 rolls)	Black	Microtex	Tacky	2mm	-
FZKTAPE020000	8021890579652	Tempo Bondcush Soft 10 Kits (20 rolls)	Black	Microtex Bondcush	Soft	3mm	-
BG02000A10003	8021890580634	Bar Gel Kit	4 Pieces of Gel (2 curved + 2 straight) + 2 wrap strips				20

COMFORTFEEL GRIPS new

Intended use: TRAIL / ENDURO / E-MTB

Weight: 95g (pair w/ lockring)

Locked-on design: la configurazione a morsetto singolo espande la superficie utilizzabile della manopola e ne estende il comfort fino al bordo esterno.

Ribbed for riding: un motivo scanalato speciale offre un'eccezionale attenuazione delle vibrazioni, mentre gli inviti ergonomici per le dita massimizzano la presa e il controllo della bici.

Palm cushioning: un ritaglio nascosto nel nucleo interno accresce l'ammortizzazione senza aumentare il diametro.

Locked-on design: la configuration avec un anneau de blocage unique élargit la surface de préhension utilisable et étend le confort jusqu'au bord extérieur de la poignée.
Ribbed for riding: un motif nervuré spécial permet d'amortir les vibrations de manière exceptionnelle, tandis que les stries ergonomiques maximisent l'adhérence et le contrôle du vélo.

Palm cushioning: une découpe cachée sur la partie centrale intérieure permet d'accroître l'amorti sans augmenter le diamètre.



RACEFEEL GRIPS new

Intended use: TRAIL / ENDURO / DH

Weight: 79g (pair w/ lockring)

Locked-on design: la configurazione a morsetto singolo espande la superficie utilizzabile della manopola e ne estende il comfort fino al bordo esterno.

Low profile, high control: forma affusolata e scanalature ergonomiche massimizzano il contatto per un migliore controllo della bici.

Palm cushioning: un ritaglio nascosto nel nucleo interno accresce l'ammortizzazione senza aumentare il diametro.

Locked-on design: la configuration avec un anneau de blocage unique élargit la surface de préhension utilisable et étend le confort jusqu'au bord extérieur de la poignée.
Low profile, high control: la forme profilée et les stries ergonomiques maximisent le contact pour un meilleur contrôle du vélo.

Palm cushioning: une découpe cachée sur la partie centrale intérieure permet d'accroître l'amorti sans augmenter le diamètre.



ARTICLE	EAN	NEW	MODEL	COLOR	DIAMETER	LENGTH	SRP (€)
FG02000A01846	8021890619495	new	Comfortfeel Grips	Black	32mm	135mm	29,90
FG02000A01847	8021890619990	new		Kaki			29,90
FG02000A01848	8021890620002	new		Burgundy			29,90
FG02000A01849	8021890620019	new		Lavander			29,90
FG01000A01846	8021890619471	new	Racefeel Grips	Black	29mm	135mm	29,90
FG01000A01847	8021890619969	new		Kaki			29,90
FG01000A01848	8021890619976	new		Burgundy			29,90
FG01000A01849	8021890619983	new		Lavander			29,90



crankbrothers





CRANKBROTHERS



PEDALS

A REVOLUTION IN TERMS OF PERFORMANCE AND RELIABILITY

NUOVI MODELLI, TECNOLOGIE AVANZATE E COMPONENTI D'ALTA GAMMA SI COMBINANO NELLA NOSTRA LINEA DI PEDALI, LA PIÙ INNOVATIVA DI SEMPRE.

DE NOUVEAUX MODÈLES, DES TECHNOLOGIES INNOVANTES ET DES COMPOSANTS HAUT DE GAMME CARACTÉRISENT NOTRE LIGNE DE PÉDALES, LE TOUT DANS UN NIVEAU DE FINITION JAMAIS ATTEINT.



LONGEVITY, DURABILITY AND PERFORMANCE PREMIUM INTERNAL COMPONENTS

ENDURO CARTRIDGE BEARING*

SISTEMA DI CUSCINETTI ESTERNI PREMIUM

- Progettati in modo specifico per pedali (bassa velocità, alto valore di coppia)
- Materiali, lubrificante e guarnizioni di qualità premium
- Maggior resistenza alla corrosione
- Tolleranze maggiori per un fit più preciso

(*) In tutti i nuovi pedali prodotti verrà installato al posto dell'Enduro Bearing l'Enduro Max cartridge bearing, ancora più affidabile.



ROULEMENT EXTERNE PREMIUM

- Conçu spécifiquement pour les pédales (basse vitesse, couple élevé)
- Matériaux, roulements et graisse de qualité supérieure
- Résistance à la corrosion
- Tolérances supérieures pour un ajustement précis

(*) Pour toute la nouvelle production de pédales, le roulement à cartouche Enduro Max, encore plus fiable, sera monté à la place du roulement Enduro.

IGUS LL-GLIDE BEARING

SISTEMA DI CUSCINETTI INTERNO PREMIUM

- Sviluppato in esclusiva per Crankbrothers
- Una performance otto volte superiore dai test in laboratorio di igus
- Una performance fino a 74 volte migliore dai test condotti da Crankbrothers
- Ottime prestazioni anche in condizioni avverse



ROULEMENT INTERNE PREMIUM

- Développés en exclusivité pour Crankbrothers
- Une performance 8 fois supérieure selon les tests de laboratoire aigus
- Une performance 74 fois supérieure selon nos derniers tests en interne.
- Effectué dans les conditions les plus extrêmes

DOUBLE SEAL SYSTEM

GUARNIZIONE INTERNA DOUBLE-LIP E GUARNIZIONE ESTERNA

- Impedisce l'entrata di sporco e acqua all'interno del pedale
- Test di laboratorio e su strada condotti in condizioni estreme
- Previene dalla corrosione dei pedali e ne aumenta la durata nel tempo

JOINT INTERNE DOUBLE-LIP ET JOINT EXTÉRIEUR

- Empêche l'eau et la boue de pénétrer à l'intérieur de la pédale
- Testé en laboratoire et sur le terrain dans les pires conditions
- Protège de la corrosion et prolonge la vie de la pédale



guarnizione interna double-lip
joint interne double-lip

guarnizione esterna
joint extérieur



CLIP-IN PEDALS MALLET DH

MALLET DH 11



MALLET DH



MALLET E

MALLET E 11



MALLET E



Ora disponibili solo nella versione Long Spindle.
Disponible uniquement dans la version Long Spindle.

Ora disponibili solo nella versione Long Spindle.
Disponible uniquement dans la version Long Spindle.

ARTICLE	UPC	MODEL	BODY COLOR	SPRING COLOR	WEIGHT*	WING MATERIAL	Q-FACTOR	PRICE (€)
16096	641300160966	Mallet DH 11	Black	Gold	445g	Titanium	57mm	350
16094	641300160942	Mallet DH	Black	Black	479g	Cast Steel	57mm	190
16095	641300160959		Red	Red				
16093	641300160935	Mallet E 11	Black	Gold	385g	Titanium	57mm	350
15990	641300159908	Mallet E	Black	Black	419g	Cast Steel	57mm	190
15991	641300159915		Electric Blue	Blue				
16080	641300160805		Blue	Black				

(*) Tutti i pesi sono intesi per coppia di pedali | Tous les poids indiqués sont par paire de pédales



CLIP-IN PEDALS MALLET TRAIL

MALLET TRAIL

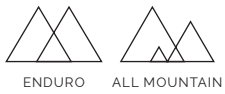

MALLET 3-2

MALLET 3



MALLET 2



ARTICLE	UPC	MODEL	BODY COLOR	SPRING COLOR	WEIGHT*	WING MATERIAL	Q-FACTOR	PRICE (€)
16759	641300167590		Black	Black				190
16760	641300167606	Mallet Trail	Champagne	Black	344g	Cast Steel	57mm	190
16761	641300167613		Purple	Black				190
15988	641300159885	Mallet 3	Raw/Black	Blue	499g	Cast Steel	52mm	150
15986	641300159861	Mallet 2	Raw/Silver	Black	508g	Stamped Steel	52mm	100

(*) Tutti i pesi sono intesi per coppia di pedali | Tous les poids indiqués sont par paire de pédales



CYCLOCROSS

XC

TRAIL

CLIP-IN PEDALS

CANDY

CANDY 11



CANDY 7



CANDY 3



ARTICLE	UPC	MODEL	BODY COLOR	SPRING COLOR	WEIGHT*	WING MATERIAL	TRACTION PADS	PRICE (€)
15984	641300159847	Candy 11	Gold	Gold	249g	Titanium	Integrated	500
16178	641300161789		Black/Electric Blue	Black				190
15981	641300159816	Candy 7	Black	Black	320g	Cast Steel	Integrated	190
15982	641300159823		Red	Red				190
16175	641300161758	Candy 3	Black	Black	340g	Cast Steel	Included	150
16176	641300161765		Slate Blue	Blue				150

(*) Tutti i pesi sono intesi per coppia di pedali | Tous les poids indiqués sont par paire de pédales

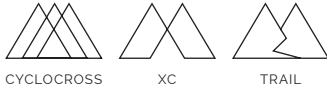

CYCLOCROSS

XC

TRAIL

CLIP-IN PEDALS

CANDY

CANDY 2



CANDY 1



ARTICLE	UPC	MODEL	BODY COLOR	SPRING COLOR	WEIGHT*	WING MATERIAL	TRACTION PADS	PRICE (€)
16173	641300161734	Candy 2	Dark Grey	Black	355g	Stamped Steel	Optional	100
16634	641300166340		Red	Black				100
16169	641300161697	Candy 1	Black	Black	294g	Stamped Steel	Not compatible	60
16171	641300161710		Light Blue	Blue				60
16170	641300161703		Red	Red				60
16172	641300161727		Pink	Pink				60

(*) Tutti i pesi sono intesi per coppia di pedali | Tous les poids indiqués sont par paire de pédales



CYCLOCROSS

XC

TRAIL

CLIP-IN PEDALS EGGBEATER

EGGBEATER 11



EGGBEATER 3

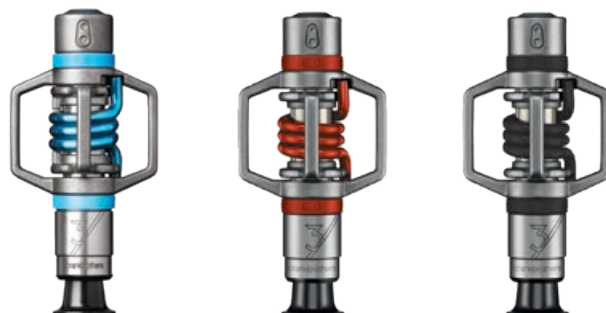

EGGBEATER 2



EGGBEATER 1

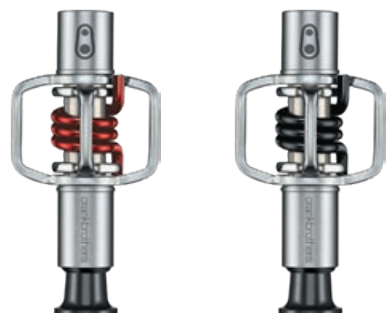

ARTICLE	UPC	MODEL	BODY COLOR	SPRING COLOR	WEIGHT*	WING MATERIAL	TRACTION PADS	PRICE (€)
11495	641300114952	Eggbeater 11	Gold	Gold	179g	Titanium	1mm included	500
16098	641300160980		Light Blue	Electric Blue				150
15319	641300153197	Eggbeater 3	Red	Red	280g	Cast Steel	1mm included	150
15859	641300158598		Black	Black				150
15317	641300153173	Eggbeater 2	Black	Black	285g	Stamped Steel	Optional	100
15985	641300159854		Black	Green				100
14792	641300147929	Eggbeater 1	Silver	Red	290g	Stamped Steel	Not compatible	60
14791	641300147912		Silver	Black				60

(*) Tutti i pesi sono intesi per coppia di pedali | Tous les poids indiqués sont par paire de pédales



MTB



CITY



TREKKING

HYBRID PEDALS DOUBLE SHOT

DOUBLE SHOT 3



CLIP-IN SIDE



FLAT SIDE

DOUBLE SHOT 2



CLIP-IN SIDE



FLAT SIDE

DOUBLE SHOT 1



CLIP-IN SIDE



FLAT SIDE

ARTICLE	UPC	MODEL	BODY COLOR	SPRING COLOR	WEIGHT*	BODY MATERIAL	PINS	Q-FACTOR	PRICE (€)
16111	641300161116	Double Shot 3	Black	Black	403g	Aluminum	8 Adjustable	57mm	150
16110	641300161109		Red/Black	Black					150
16006	641300160065		Black/Silver	Blue					100
16007	641300160072	Double Shot 2	Orange/Black	Orange	395g	Aluminum	8 Molded	57mm	100
16077	641300160775		Blue/Black	Black					100
16179	641300161796		Black	Black					60
16181	641300161819	Double Shot 1	Blue	Black	331g	Composite	8 Molded	57mm	60
16180	641300161802		Red	Black					60

(*) Tutti i pesi sono intesi per coppia di pedali | Tous les poids indiqués sont par paire de pédales

FLAT PEDALS

FIND YOUR PERFECT SIZE

OPTIMAL SURFACE AREA

- Basato sull'analisi delle misure delle scarpe e della superficie delle soles
 - Due misure, ciascuna con una superficie ottimizzata in base alla taglia
 - Aumento del grip, del supporto e del contatto con il pedale
 - Riduce il peso e l'area d'impatto con le rocce
- Basée sur l'analyse des dimensions des chaussures et la surface des semelles
 - Deux différentes tailles avec des surfaces optimales pour les diverses gammes de tailles de chaussures
 - Optimise l'adhérence, le support et l'interface avec la pédale
 - Réduit considérablement le poids et prévient des chocs avec le terrain

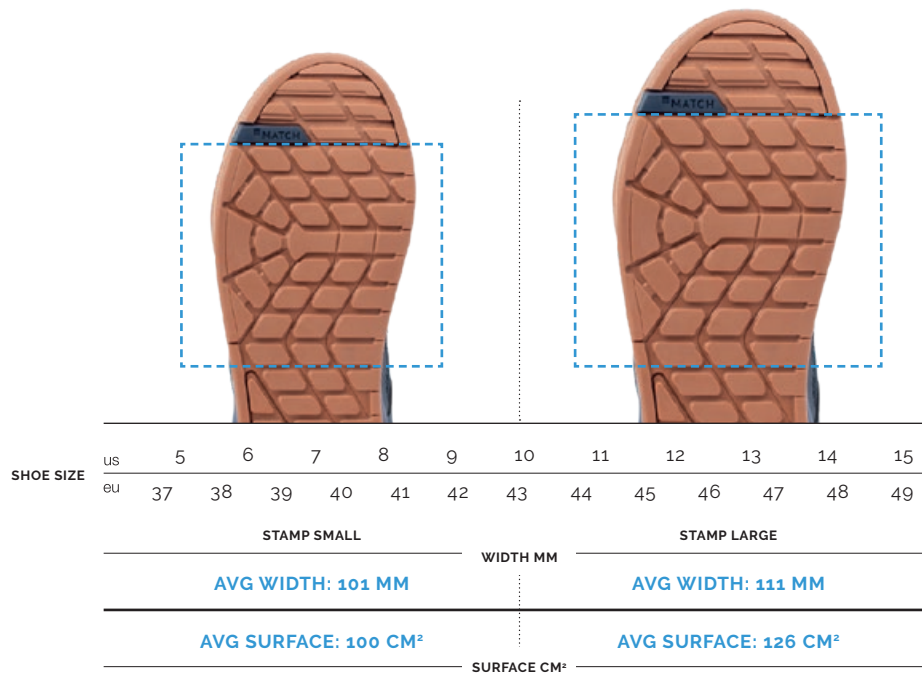
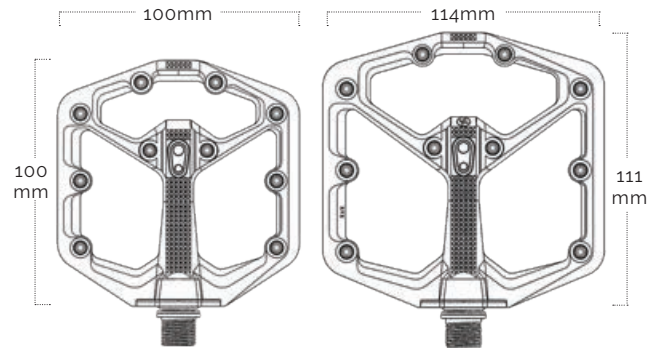

MINIMUM PROFILE/MAXIMUM CONCAVITY

- Profilo minimal, 11-13 mm (Stamp 11 & 7);
13.5 - 15.5 mm (Stamp 1 Gen 2)
 - Un profilo più fino rispetto alla concorrenza
 - Riduce il peso e l'impatto con le rocce
 - La piattaforma concava garantisce una presa più salda del piede sul pedale
 - Una piattaforma più concava rispetto alla concorrenza
- Profil minimal, 11-13 mm (Stamp 11 & 7);
13.5 - 15.5 mm (Stamp 1 Gen 2)
 - Profil plus mince que les produits de la concurrence
 - Réduit le poids et les chocs avec le terrain
 - Plate forme concave, positionnement du pied plus sûr
 - Concavité supérieure aux produits de la concurrence

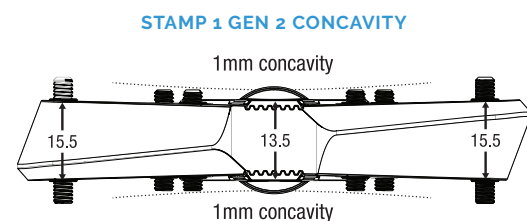
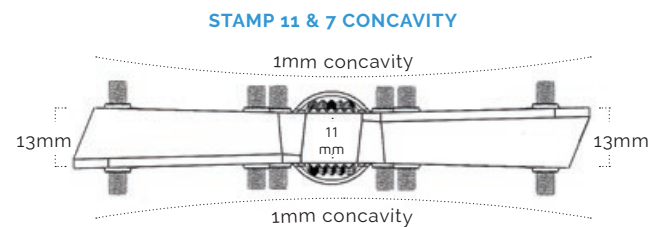



FLAT PEDALS
STAMP



STAMP 11



STAMP 7



ARTICLE	UPC	MODEL	SIZE	BODY COLOR	WEIGHT*	BODY MATERIAL	THICKNESS	PRICE (€)
16165	641300161659	Stamp 11	Large	Black/Gold	325g	Aluminum	11/13 mm	300
16166	641300161666		Small	Black/Gold	299g	Aluminum	11/13 mm	300
16002	641300160027	Stamp 7	Large	Black	375g	Aluminum	11/13 mm	180
16003	641300160034		Large	Red	375g	Aluminum	11/13 mm	180
16635	641300166357		Large	Electric Blue	375g	Aluminum	11/13 mm	180
16746	641300167460		Large	High Polish Silver	375g	Aluminum	11/13 mm	190
16004	641300160041		Small	Black	345g	Aluminum	11/13 mm	180
16005	641300160058		Small	Red	345g	Aluminum	11/13 mm	180
16636	641300166364		Small	Electric Blue	345g	Aluminum	11/13 mm	180
16747	641300167477	Small	High Polish Silver	345g	Aluminum	11/13 mm	190	

(*) Tutti i pesi sono intesi per coppia di pedali | Tous les poids indiqués sont par paire de pédales



FLAT PEDALS

STAMP



STAMP 3



STAMP 2



ARTICLE	UPC	MODEL	SIZE	BODY COLOR	WEIGHT*	BODY MATERIAL	THICKNESS	PRICE (€)
16366	641300163660	Stamp 3	Large	Black Magnesium	386g	Magnesium	16 mm	140
16367	641300163677		Large	Grey Magnesium	386g	Magnesium	16 mm	140
16368	641300163684		Small	Black Magnesium	351g	Magnesium	16 mm	140
16369	641300163691		Small	Grey Magnesium	351g	Magnesium	16 mm	140
16362	641300163622	Stamp 2	Large	Raw Silver	494g	Die Cast Aluminum	16 mm	100
16363	641300163639		Large	Black	494g	Die Cast Aluminum	16 mm	100
16364	641300163646		Small	Raw Silver	439g	Die Cast Aluminum	16 mm	100
16365	641300163653		Small	Black	439g	Die Cast Aluminum	16 mm	100

(*) Tutti i pesi sono intesi per coppia di pedali | Tous les poids indiqués sont par paire de pédales



FLAT PEDALS STAMP 1 GEN 2



STAMP 1 GEN 2



STAMP 1 GEN 2 | KEY FEATURES

- Profilo minimale
- 10 perni pedale sostituibili
- Corpo in composito rinforzato
- Mandrino in acciaio Cromolly
- Cuscinetti e sistema sigillato di qualità superiore
- Garanzia di 5 anni

- Profil minimal
- 10 picots remplaçables par pédale
- Corps en composite renforcé
- Axe en acier Chromoly
- Roulements et système d'étanchéité Premium
- Garantie 5 ans

ARTICLE	UPC	MODEL	SIZE	BODY COLOR	WEIGHT*	BODY MATERIAL	THICKNESS	PRICE (€)
16809	641300168092	Stamp 1 - Gen 2	Large	Black	348g	Reinforced Composite	13.5/15.5mm	60
16811	641300168115		Large	Red	348g	Reinforced Composite	13.5/15.5mm	60
16813	641300168139		Large	Orange	348g	Reinforced Composite	13.5/15.5mm	60
16815	641300168153		Large	Navy Blue	348g	Reinforced Composite	13.5/15.5mm	60
16817	641300168177		Large	Purple	348g	Reinforced Composite	13.5/15.5mm	60
16810	641300168108		Small	Black	299g	Reinforced Composite	13.5/15.5mm	60
16812	641300168122		Small	Red	299g	Reinforced Composite	13.5/15.5mm	60
16814	641300168146		Small	Orange	299g	Reinforced Composite	13.5/15.5mm	60
16816	641300168160		Small	Navy Blue	299g	Reinforced Composite	13.5/15.5mm	60
16818	641300168184		Small	Purple	299g	Reinforced Composite	13.5/15.5mm	60

(*) Tutti i pesi sono intesi per coppia di pedali | Tous les poids indiqués sont par paire de pédales

PEDALS ACCESSORIES

CLEAT COLLECTION

STANDARD RELEASE 6° FLOAT CLEAT

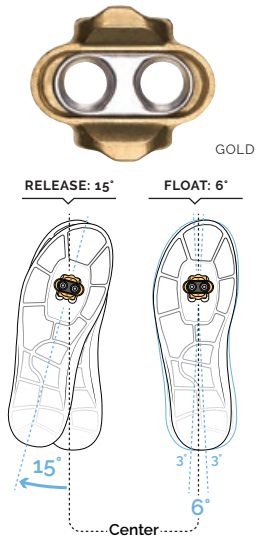

STANDARD RELEASE 0° FLOAT CLEAT

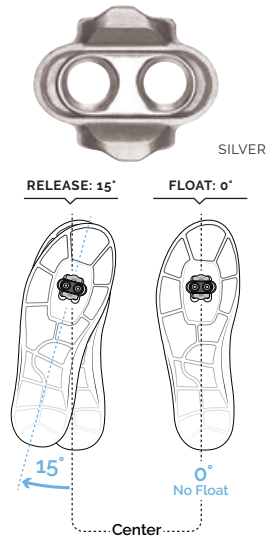

EASY RELEASE 6° FLOAT CLEAT

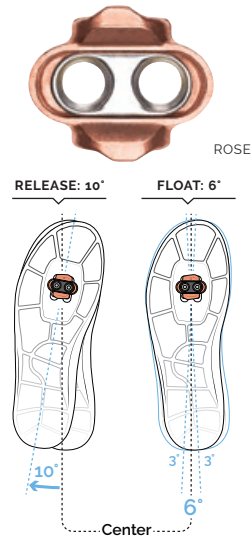

EASY RELEASE 0° FLOAT CLEAT

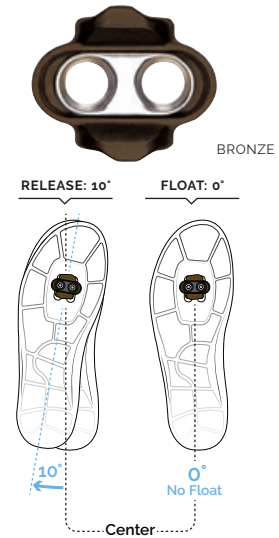

CLEAT TOOL



CLEAT ACCESSORIES



CLEAT POP KIT (INCLUDES 16 PAIRS OF CLEATS)



ARTICLE	UPC	NEW	COLLECTION	MODEL	PRICE (€)
10060	641300600127			Cleat Standard Release 6 degree	27
15338	641300153388			Cleat Standard Release 0 degree	27
16275	641300162755		Cleat Collection	Cleat Easy Release 6 degree	27
16276	641300162762			Cleat Easy Release 0 degree	27
17033	641300170330	new	Cleat Tool	Cleat Tool Grey V2	6
16685	641300166852		Cleat Accessories	Match Shoe Shim 1,5mm - Grey	5
16917	641300169174	new		Match Shoe Shim 1,0mm - Black	5
16351	641300163516		Cleat Pop Kit	Cleat Kit 16 Units with Fitting Tool and Display French	-
16354	641300163547			Cleat Kit 16 Units with Fitting Tool and Display Italian	-



PEDALS ACCESSORIES

CLEAT AND PEDAL ACCESSORIES



METAL SHOE SHIELDS



3 HOLE ROAD CLEAT



CANDY 7/11 TRACTION PADS



CANDY 2/3 TRACTION PADS
2017 - 2018



MALLET E/DH TRACTION PADS



EGGBEATER 2/3/11 TRACTION PADS

REFRESH KIT COLLECTION



LONG SPINDLE KIT



TITANIUM SPINDLE KIT



REFRESH KIT



REFRESH KIT
EGGBEATER 11 / CANDY 11

new

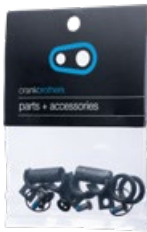

REFRESH KIT
STAMP 1 GEN 2



REFRESH KIT
STAMP 7 / 11



REFRESH KIT
DOUBLE SHOT 2 / 3



10MM PIN KIT



8MM PIN KIT

ARTICLE	UPC	NEW	COLLECTION	MODEL	PRICE (€)
10000	641300670007			Metal Shoes Shields/Pair	10
15289	641300152893			3 Hole Cleat Kit	30
16057	641300160577		Cleat and Pedal Accessories	Candy 7/11 Traction Pads	15
16217	641300162175			Candy 2/3 Traction Pads (Model 2017)	10
16058	641300160584			Mallet E/DH Traction Pads	15
16509	641300165091			Eggbeater 2/3/11 Traction Pads	10
16067	641300160676			Long Spindle Upgrade Kit	50
16068	641300160683		Titanium Spindle Upgrade Kit	180	
16051	641300160515			Pedal Refresh Kit - All*	30
16229	641300162298			Pedal Refresh Kit - For Candy 11 & Eggbeater 11 only	30
16957	641300169570	new	Refresh Kit Collection	Pedal Refresh Kit - For Stamp 1 Gen 2	25
16273	641300162731			Pedal Refresh Kit - For Stamp 7/11	25
16274	641300162748			Pedal Refresh Kit - For Double Shot 2/3	30
13890	641300138903			Flats 10mm Pin Kit	12
13891	641300138910		Flats 8mm Pin Kit	12	

(*) Compatibility: Eggbeater 2/3, Candy 2/3, Split Body (V1 2010-2017) / 7, Mallet 2 / 3 / E / DH / Trail, Stamp 1 / 2 / 3 (V1, 2017-2019), 5050 2 / 3



FOOTWEAR

THE CRANKBROTHERS SHOE COLLECTION

LA LINEA DI SCARPE CRANKBROTHERS E' STATA CREATA CON L'OBIETTIVO DI MIGLIORARE L'ESPERIENZA IN BICI DI OGNI RIDER: LA TECNOLOGIA MATCH SYSTEM, INFATTI, È STATA SVILUPPATA PER OFFRIRE LA MIGLIORE INTERFACCIA SCARPA/PEDALE E GARANTIRE UN CONTROLLO E UNA SICUREZZA SUPERIORI SUI SENTIERI, SIA CHE TU SCELGA DI USARE I PEDALI A SGANCIO RAPIDO SIA CHE PREFERISCA QUELLI FLAT.

LA LIGNE DE CHAUSSURES CRANKBROTHERS A ÉTÉ CRÉÉE POUR AMÉLIORER CHAQUE SORTIE. LA TECHNOLOGIE MATCH SYSTEM A ÉTÉ DÉVELOPPÉE POUR OFFRIR LA MEILLEURE INTERFACE CHAUSSURE/PÉDALE, GARANTISSANT UNE SÉCURITÉ ET UN CONTRÔLE SUPÉRIEURS SUR LES TRAILS, QUE L'ON UTILISE DES PÉDALES AUTOMATIQUES OU PLATES.



MATCH SYSTEM



PER ABBINARE IL PEDALE CON LA SCARPA POUR ACCOUPPLER LA PÉDALE À LA CHAUSSURE

MATCH È UN APPROCCIO DI DESIGN INTEGRATO CHE CONSIDERA IL PEDALE E LA SCARPA COME UN SISTEMA UNICO CHE ASSICURA L'INTERFACCIA OTTIMALE.

MATCH EST UNE APPROCHE DE CONCEPTION INTÉGRÉE QUI CONSIDÈRE LA PÉDALE ET LA CHAUSSURE COMME UN SYSTÈME UNIFIÉ POUR FOURNIR L'INTERFACE OPTIMALE.

MATCH SHIM CHART



SPD



CRANKBROTHERS



CLEAT ONLY

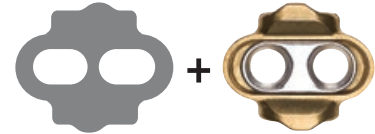

SHIM + CLEAT

OTTIMIZZATO PER OGNI SISTEMA DI AGGANCO DELLE MTB
OPTIMISÉ POUR TOUT SYSTÈME DE PÉDALES AUTOMATIQUES DE VTT

INGAGGIO OTTIMIZZATO PER SISTEMI DI AGGANCO CRANKBROTHERS
 INGAGGIO DUREVOLE CON I PEDALI CRANKBROTHERS

OPTIMISÉ POUR L'ENCLÈNCHÉMENT DES PÉDALES CRANKBROTHERS ENCLÈNCHÉMENT DURABLE
 AVEC LES PÉDALES CRANKBROTHERS

SHIM THICKNESS CHART:		PEDALS			
GREY: 1.5mm BLACK: 1mm BLACK: 1mm					
		MALLET DH	MALLET E	MALLET TRAIL	CANDY
SHOES					X
	MALLET	PRE-INSTALLED	PRE-INSTALLED	USE BLACK SHIM INCLUDED WITH PEDALS / USE #16917 (AVAILABLE SEPARATELY)	SHIM NOT RECOMMENDED
					X
	MALLET E	PRE-INSTALLED	PRE-INSTALLED	USE BLACK SHIM INCLUDED WITH PEDALS / USE #16917 (AVAILABLE SEPARATELY)	SHIM NOT RECOMMENDED
MALLET TRAIL	INCLUDED IN SHOE PACKAGING	INCLUDED IN SHOE PACKAGING	PRE-INSTALLED	PRE-INSTALLED	
	X	X			
CANDY XC	SHIM NOT RECOMMENDED	SHIM NOT RECOMMENDED	USE BLACK SHIM INCLUDED WITH PEDALS / USE #16917 (AVAILABLE SEPARATELY)	USE BLACK SHIM INCLUDED WITH PEDALS / USE #16917 (AVAILABLE SEPARATELY)	



MATCH BOX



ACCESSO E USCITA FACILI
ENCLÈNEMENT ET DÉENCLÈNEMENT FACILES

PRONTI DA USARE | PRÊT À ROULER



ESPERIENZA D'ACQUISTO MIGLIORATA

TACCHETTA PREINSTALLATA IN POSIZIONE NEUTRALE SU TUTTE LE SCARPE CLIP-IN
AD ECCEZIONE DEL MODELLO CANDY.

EXPÉRIENCE D'ACHAT AMÉLIORÉE

LA CALE EST PRÉ-INSTALLÉE EN POSITION NEUTRE SUR TOUTES LES CHAUSSURES CLIP-IN,
À L'EXCEPTION DU MODÈLE CANDY.

TRAIL SHOES COLLECTION

BOA® SYSTEM E STRAP

CARATTERISTICHE DELLA TOMAIA | CARACTERISTIQUES DE L'EMPEIGNE



CLIP-IN OUTSOLE

MATCH OUTSOLE

- Disegno del battistrada progettato per offrire trazione anche mentre si cammina
- Tacchetti sulla punta e sul tallone orientati in modo angolato e distanziato per garantire trazione durante le escursioni su terreni ripidi in salita o discesa
- Punta inclinata per una camminata migliore
- Struttura rigida in nylon rinforzato da fibra per un efficiente trasferimento di potenza
- Rivestimento in gomma della parte anteriore per una protezione extra della punta
- Motif de la bande de roulement conçu pour l'adhérence en dehors du vélo
- Les ergots directionnels angulaires et espacés au niveau des orteils et du talon offrent une bonne adhérence pour les randonnées sur terrains escarpés
- Bout en forme de rampe pour une marche facilité
- Tige rigide en nylon renforcé de fibres pour le transfert de puissance
- Caoutchouc enveloppé à l'avant pour une protection supplémentaire des orteils

MATCH COMPOUND

- Composto in gomma MC1 a media aderenza che consente un facile inserimento e sgancio del pedale
- Resistenza migliorata all'usura e agli strappi
- Tacchetti arrotondati per diminuire l'abrasione
- Le composé de caoutchouc MC1 à friction moyenne facilite l'entrée et la sortie de la pédale
- Résistance accrue à l'usure et à la déchirure
- Cosses arrondies pour une meilleure résistance à l'abrasion



LACE UP

CARATTERISTICHE DELLA TOMAIA | CARACTERISTIQUES DE L'EMPEIGNE



FLAT OUTSOLE



MATCH OUTSOLE

- I tasselli profondi, posizionati in modo uniforme, sono progettati per garantire una presa sicura sui pin
- I tasselli della punta e del tallone sono inclinati e spaziosi in modo direzionale per offrire trazione durante la salita o la discesa su terreni ripidi
- Il disegno del battistrada è progettato per garantire trazione mentre si cammina
- La punta inclinata permette una camminata migliore
- Intersuola in Eva per smorzare le vibrazioni
- Rivestimento in gomma nella parte anteriore per una protezione extra delle dita dei piedi
- Les ergots profonds et régulièrement placés sont conçus pour sécuriser les picots
- Les ergots directionnels et espacés au niveau des orteils et du talon offrent l'adhérence pour les randonnées en terrain escarpé
- La bande de roulement est conçue pour la traction en dehors du vélo
- Le bout de la chaussure est arrondi pour faciliter la marche
- Semelle intermédiaire Eva pour amortir les vibrations
- Avant enveloppé en caoutchouc pour une protection supplémentaire des orteils

MATCH COMPOUND

- La mescola è ottimizzata per una presa solida e una maggiore durata
- Ha un elevato grip per aderire al meglio al corpo del pedale e una bassa capacità di rimbalzo per smorzare le vibrazioni
- I tasselli sono arrotondati per resistere all'abrasione
- Composé optimisé pour l'adhérence et la durabilité
- Possède un fort coefficient de friction pour adhérer au corps de la pédale et de faibles propriétés de rebond pour amortir les vibrations
- Les ergots sont arrondis pour résister à l'abrasion

CLIP-IN SHOES

MALLET TRAIL BOA®



new

MALLET TRAIL SPEEDLACE



MALLET TRAIL LACE



ARTICLE	NEW	MODEL	STYLE	COLOR	OUSOLE	CLOSURE	SIZE	WEIGHT	PRICE (€)
MTB41080A		Mallet Trail BOA®	Clip-in	Black/Gold	Gum	BOA® + Strap	37-49	410g (Single - Size 42)	220
MTS47682A	new	Mallet Trail	Clip-in	Sand/Brown	Gum	Speedlace	37-49	405g (Single - Size 42)	180
MTS45476A	new	Speedlace		Green/Sand	Gum				
MTL41010A				Black/Black	Gum				170
MTL42095A		Mallet Trail Lace	Clip-in	White/Purple	Purple	Lace	37-49	385g (Single - Size 42)	170
MTL44040A				Blue/Blue	Gum				170

Tutti i modelli sono disponibili nelle taglie piene | Tous les modèles sont disponibles en tailles pleines



FLAT SHOES

STAMP TRAIL BOA®



STAMP TRAIL LACE



ARTICLE	MODEL	STYLE	COLOR	OUSOLE	CLOSURE	SIZE	WEIGHT	PRICE (€)
TRB41080A	Stamp Trail BOA®	Flat	Black/Gold	Gum	BOA® + Strap	37-49	320g (Single - Size 42)	200
TRL41010A			Black/Black	Gum				150
TRL42095A	Stamp Trail Lace	Flat	White/Purple	Purple	Lace	35-49	295g (Single - Size 42)	150
TRL44040A			Blue/Blue	Gum				150

Tutti i modelli sono disponibili nelle taglie piene | Tous les modeles sont disponibles en tailles pleines

MALLET, MALLET E, STAMP COLLECTION

LACE UP

CARATTERISTICHE DELLA TOMAIA | CARACTERISTIQUES DE L'EMPEIGNE



MATERIALI PREMIUM | MATÉRIAUX DE QUALITÉ SUPÉRIEURE

TRASPIRABILITÀ/RESPIRABILITÉ

Materiali traforati e inserti ventilanti in mesh garantiscono massima traspirabilità. Les matériaux perforés et les ouvertures en mesh ventilé assurent la respirabilité.

PROTEZIONE/PROTECTION

Punta realizzata in materiali rinforzati per protezione dagli impatti. Les matériaux renforcés au niveau des orteils offrent une protection contre les impacts.

COMFORT/CONFORT

Linguetta e fodera tallone imbottite per massimo comfort durante tutta la giornata. La languette et les talons rembourrés offrent un confort tout au long de la journée et un ajustement supérieur.

TRE TIPOLOGIE DI CHIUSURA | TROIS OPTIONS DE FERMETURE



BOA® SYSTEM & STRAP



SPEEDLACE & STRAP



LACE



CLIP-IN SHOES
MALLET BOA®



MALLET SPEEDLACE



MALLET LACE



LIMITED EDITION



LIMITED EDITION

ARTICLE	MODEL	STYLE	COLOR	OUSOLE	CLOSURE	SIZE	WEIGHT	PRICE (€)
MAB01080A	Mallet BOA®	Clip-in	Black/Gold	Black	BOA® + Strap	37-49	429g (Single - Size 42)	200
MAS01020A	Mallet Speedlace	Clip-in	Black/White	Black	Speedlace + Strap	37-48	428g (Single - Size 42)	170
MAL01030A	Mallet Lace	Clip-in	Black/Red	Black	Lace	40-47	415g (Single - Size 42)	150
MAL17040S	Mallet Lace Limited Edition	Clip-in	Grey/Blue*	Gum	Lace	40-47	415g (Single - Size 42)	150
MAL15152S			Petrol/Lime*					150

Tutti i modelli sono disponibili nelle taglie piene | Tous les modèles sont disponibles en tailles pleines

(*) Fino ad esaurimento scorte | Jusqu'à épuisement des stocks

CLIP-IN SHOES
MALLET E SPEEDLACE



MALLET E LACE



ARTICLE	MODEL	STYLE	COLOR	OUSOLE	CLOSURE	SIZE	WEIGHT	PRICE (€)
MES05443A	Mallet E Speedlace	Clip-in	Green/Blue*	Gum	Speedlace + Strap	41-45	437g (Single - Size 42)	170
MEL01043A	Mallet E Lace	Clip-in	Black/Blue*	Black	Lace	38-45	432g (Single - Size 42)	150

Tutti i modelli sono disponibili nelle taglie piene | Tous les modeles sont disponibles en tailles pleines

(*) Fino ad esaurimento scorte | Jusqu'à épuisement des stocks



FLAT SHOES
STAMP BOA®



STAMP SPEEDLACE



ARTICLE	MODEL	STYLE	COLOR	OUSOLE	CLOSURE	SIZE	WEIGHT	PRICE (€)
STB01080A	Stamp BOA®	Flat	Black/Gold	Black	BOA® + Strap	37-49	379g (Single - Size 42)	180
STS21020A			Black/White	Black		37-48		150
STS29546A	Stamp Speedlace	Flat	Purple/Teal Blue	Gum	Speedlace	37-48	383g (Single - Size 42)	150
STS05435A			Green/Orange*	Black	+ Strap	38-48		150
STS07030A			Grey/Red*	Black		41-48		150

Tutti i modelli sono disponibili nelle taglie piene | Tous les modèles sont disponibles en tailles pleines

(*) Fino ad esaurimento scorte | Jusqu'à épuisement des stocks

FLAT SHOES
STAMP LACE



LIMITED EDITION



LIMITED EDITION

STAMP STREET LACE



STREET

ARTICLE	MODEL	STYLE	COLOR	OUSOLE	CLOSURE	SIZE	WEIGHT	PRICE (€)
STL01081A			Black/Silver			35-48		130
STL02086A	Stamp Lace	Flat	White/White	Gum	Lace	35-48	376g (Single - Size 42)	130
STL04281A			Navy/Silver			37-49		130
STL17040S	Stamp Lace		Grey/Blue*					130
STL15152S	Limited Edition	Flat	Petrol/Lime*	Gum	Lace	38-47	376g (Single - Size 42)	130
SSL11080F	Stamp		Black/Gold					130
SSL12080F	Street Lace	Flat	White/Gold	Gum	Lace	35-48	570g (Single - Size 42)	130

Tutti i modelli sono disponibili nelle taglie piene | Tous les modèles sont disponibles en tailles pleines

(*) Fino ad esaurimento scorte | Jusqu'à épuisement des stocks



CANDY LACE SHOES COLLECTION

LACE UP

CARATTERISTICHE DELLA TOMAIA | CARACTERISTIQUES DE L'EMPEIGNE



LASER-CUT MATERIALS
AND PERFORATED TONGUE
FOR BREATHABILITY

LACE CLOSURE SYSTEM,
WITH ELASTIC RETENTION LOOP
TO KEEP THINGS IN CHECK

PU FILM FOR ABRASION
RESISTANCE AND EASY
CLEANING

TPU TOE
PROTECTION



CLIP-IN OUTSOLE

MATCH OUTSOLE

- Suola in gomma e disegno del battistrada progettati per garantire trazione anche mentre si cammina
- Lungo canale centrale per un inserimento fluido del pedale e per facilitare la rimozione del fango
- Possibilità di scegliere la posizione ottimale delle tacchette grazie a una pista di 35 mm
- Zona antiscivolo nel caso in cui il pedale non venga agganciato
- La semelle extérieure en caoutchouc et la bande de roulement sont conçues pour la traction en dehors du vélo
- Long canal central pour un accès ininterrompu à la pédale et une évacuation de la boue
- Possibilité de choisir la position optimale de la cale grâce à un espace de cale étendu de 35 mm
- Zone antidérapante si vous ne vous engagez pas sur la pédale

MATCH COMPOUND

- Il composto di gomma MC1 a media aderenza consente un facile inserimento e sgancio del pedale
- Resistenza migliorata all'usura e alle sollecitazioni
- Tacchetti arrotondati per resistere all'abrasione
- Le composé de caoutchouc MC1 à friction moyenne facilite l'entrée et la sortie de la pédale.
- Résistance accrue à l'usure et à la déchirure
- Cosses arrondies pour résister à l'abrasion





CLIP-IN SHOES
CANDY GRAVEL / XC LACE



new colour

ARTICLE	NEW	MODEL	STYLE	COLOR	OUSOLE	CLOSURE	SIZE	WEIGHT	PRICE (€)
CGL41010A		Candy Gravel/ Xc Lace	Clip-in	Black/Black	Gum				160
CGL42070A				White/Grey	Grey	Lace	37-49	340g (Single - Size 42)	160
CGL45454A	new			Green/Dark Green	Green				160

Tutti i modelli sono disponibili nelle taglie piene | Tous les modèles sont disponibles en tailles pleines

SOCKS
ICON MTB SOCKS



WHITE / RED / BLACK



BLACK / GOLD / GREY



WHITE / BROWN / BLACK



BLUE / WHITE

LACES
BOA® REPLACEMENT KIT



LACES
SPEEDLACE



PINK BLACK RED ORANGE



LIGHT BLUE WHITE SILVER

LACES
ROUNDED LACE



PINK BLACK RED ORANGE LIGHT BLUE WHITE SILVER



LACES
FLAT LACE



ARTICLE	UPC	MODEL	COLOR	SIZE	PRICE (€)
81254	641300812544	Icon Mtb Sock	White/Red/Black	Small/Medium	15,90
81255	641300812551		White/Red/Black	Large/X-Large	15,90
81223	641300812230		Black/Gold/Grey	Small/Medium	15,90
81224	641300812247		Black/Gold/Grey	Large/X-Large	15,90
81230	641300812308		White/Brown/Black	Small/Medium	15,90
81231	641300812315		White/Brown/Black	Large/X-Large	15,90
81228	641300812285		Navy Blue/White	Small/Medium	15,90
81229	641300812292		Navy Blue/White	Large/X-Large	15,90
16751	641300167514	BOA® Li2 Replacement Kit	Black	TU	30,00
16638	641300166388	BOA® L6 Replacement Kit	Black	TU	22,00
16738	641300167385	Speedlace	Pink	TU	10,90
16639	641300166395		Black	TU	10,90
16640	641300166401		Red	TU	10,90
16641	641300166418		Orange	TU	10,90
16642	641300166425		Light Blue	TU	10,90
16643	641300166432		White	TU	10,90
16644	641300166449		Silver	TU	10,90
16736	641300167361	Rounded Lace	Pink	Small/Medium	5,90
16737	641300167378		Pink	Large/X-Large	5,90
16645	641300166456		Black	Small/Medium	5,90
16657	641300166579		Black	Large/X-Large	5,90
16646	641300166463		Red	Small/Medium	5,90
16658	641300166586		Red	Large/X-Large	5,90
16647	641300166470		Orange	Small/Medium	5,90
16659	641300166593		Orange	Large/X-Large	5,90
16648	641300166487		Light Blue	Small/Medium	5,90
16660	641300166609		Light Blue	Large/X-Large	5,90
16649	641300166494		White	Small/Medium	5,90
16661	641300166616		White	Large/X-Large	5,90
16650	641300166500		Silver	Small/Medium	5,90
16662	641300166623		Silver	Large/X-Large	5,90
16729	641300167293	Flat Lace	Black	Small/Medium	5,90
16730	641300167309		White	Small/Medium	5,90
16740*	641300167408		White	Large/X-Large	5,90
16731	641300167316		Sage Green	Small/Medium	5,90
16741*	641300167415		Sage Green	Large/X-Large	5,90
16732	641300167323		Silver	Small/Medium	5,90
16742*	641300167422		Silver	Large/X-Large	5,90
16733	641300167330		Orange	Small/Medium	5,90
16743*	641300167439		Orange	Large/X-Large	5,90
16734	641300167347		Blue	Small/Medium	5,90
16744*	641300167446		Blue	Large/X-Large	5,90
16735	641300167354		Pink	Small/Medium	5,90
16745*	641300167453		Pink	Large/X-Large	5,90

(*) Fino ad esaurimento scorte | Jusqu'à épuisement des stocks



WHEELS

SYNTHESIS

WHEEL SYSTEM

LE RUOTE SYNTHESIS CARBON HANNO UNA GARANZIA A VITA.
DETTAGLI SU [CRANKBROTHERS.COM](https://www.crankbrothers.com)

LES ROUES SYNTHESIS CARBON OFFRENT UNE GARANTIE À VIE.
POUR PLUS D'INFORMATIONS ALLEZ SUR [CRANKBROTHERS.COM](https://www.crankbrothers.com)



TUNED WHEEL SYSTEM

STRUTTURA RUOTA ANTERIORE

- Ridotto numero di raggi
- Tensione sui raggi inferiore
 - Raggi alleggeriti
 - Cerchio alleggerito
- Canale del cerchio più largo

STRUCTURE ROUE AVANT

- Nombre de rayons réduit
- Tension des rayons inférieure
 - Rayons allégés
 - Jante allégée
- Profil intérieur de la jante plus large

STRUTTURA RUOTA POSTERIORE

- Maggiore numero di raggi
- Tensione sui raggi maggiore
- Maggiore robustezza del raggio
 - Cerchio più resistente
- Canale del cerchio più stretto

STRUCTURE ROUE ARRIÈRE

- Nombre de rayons plus élevés
- Tension des rayons supérieure
 - Rayons renforcés
 - Jante plus résistante
- Profil intérieur de la jante plus étroit

CONTROLLO NELLE CURVE | MAITRISE EN COURBE

COMPLIANT FRONT WHEEL



MANEGGEVOLEZZA OTTIMIZZATA

- Smorza le vibrazioni sui trail
- Riduce la stanchezza del biker
- Attutisce e assorbe gli impatti

CONDUITE PLUS MANIABLE

- Amortit les vibrations
- Réduit la fatigue du pilote
- Diminue et absorbe les chocs



TRAIETTORIE SICURE

- Migliora l'aderenza
- Migliora l'ingresso in curva in velocità
- Tiene la copertura attaccata al suolo

TRAJECTOIRES MAITRISEES

- Améliore l'adhérence
- Améliore la vitesse en courbe
- Maintient l'accroche du pneu au sol



CANALE DEL CERCHIO A LARGHEZZA MAGGIORATA

- Aumenta il volume d'aria della copertura per una migliore aderenza
- Il profilo arrotondato della copertura migliora le sterzate
- Supporta le coperture di grossa sezione sull'anteriore

PROFIL INTÉRIEUR DE LA JANTE PLUS LARGE

- Augmentation du volume d'air du pneu améliorant l'adhérence
- Le profil arrondi du pneu facilite le guidage en virage
- Supporte le montage de pneus de grosse section sur la roue avant

STABILITÀ E CONTROLLO IN VELOCITÀ | STABILITÉ ET CONTRÔLE À VITESSE ÉLEVÉE

STIFF REAR WHEEL

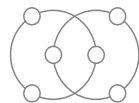

CARICHI DIREZIONALI / RADIALI TOLLERATI PERFETTAMENTE

- Reattività
- Mantiene velocità e momento di inerzia
 - Stabilità
- Tollera le compressioni
- Ancora il biker al centro di gravità

SUPPORTE PARFAITEMENT LES CHARGES DIRECTIONNELLES ET RADIALES

- Réactivité
- Vitesse maintenue et moment d'inertie
 - Stabilité
- Absorbe les pics de compression
- Maintient le centre de gravité du pilote



CANALE DEL CERCHIO PIÙ STRETTO

- Riduce le pizzicature
- Migliora la resistenza al rotolamento
- Tassellatura più pronunciata per l'aderenza

PROFIL INTÉRIEUR DE LA JANTE PLUS ÉTROIT

- Réduit la zone de contact
- Diminue la résistance au roulement
- Améliore l'adhérence du pneu

Queste informazioni si riferiscono all'intera famiglia Synthesis, ad eccezione di Synthesis Gravel.
Ces informations concernent l'ensemble de la famille Synthesis, à l'exception de Synthesis Gravel.



CARBON SINGLE WHEEL SYNTHESIS DH 11

new

PRECISA IN VELOCITÀ | GUIDAGE PRECIS A HAUTE VITESSE

HUB
INDUSTRY NINE HYDRA HUB

ENGAGEMENT
0.52" QUICK ENGAGEMENT / SIX PAWLS

SPOKES
SAPIM CX-RAY (FRONT)
SAPIM CX-SPRINT (REAR)



FRONT



REAR

COMPLIANT FRONT WHEEL

SPOKE COUNT: 28
INNER RIM WIDTH: 31.5

STIFF REAR WHEEL

SPOKE COUNT: 32
INNER RIM WIDTH: 31.5

OUTER RIM WIDTH

OUTER RIM WIDTH FRONT: 38.7 MM
REAR: 39.5 MM

ARTICLE	UPC	NEW	MODEL	DIAMETER	HUB	DRIVER BODY	FRONT AXLE	REAR AXLE	RIM	WEIGHT	PRICE (€)
16961	641300169617	new	Synthesis DH 11	27.5" Front	Boost i9 Hydra	-	20x110mm	-	Carbon Premium	865g	1000
16962	641300169624	new		27.5" Rear	Boost i9 Hydra	XD	-	157x12mm	Carbon Premium	1075g	1400
16963	641300169631	new		27.5" Rear	Boost i9 Hydra	Shimano HG	-	157x12mm	Carbon Premium	1075g	1400
17006	641300170064	new		27.5" Rear	Boost i9 Hydra	XD	-	148x12mm	Carbon Premium	1116g	1400
17007	641300170071	new		27.5" Rear	Boost i9 Hydra	Shimano HG	-	148x12mm	Carbon Premium	1116g	1400
16964	641300169648	new		29" Front	Boost i9 Hydra	-	20x110mm	-	Carbon Premium	899g	1000
16965	641300169655	new		29" Rear	Boost i9 Hydra	XD	-	157x12mm	Carbon Premium	1203g	1400
16966	641300169662	new		29" Rear	Boost i9 Hydra	Shimano HG	-	157x12mm	Carbon Premium	1203g	1400
17008	641300170088	new		29" Rear	Boost i9 Hydra	XD	-	148x12mm	Carbon Premium	1164g	1400
17009	641300170095	new		29" Rear	Boost i9 Hydra	Shimano HG	-	148x12mm	Carbon Premium	1164g	1400



CARBON SINGLE WHEEL SYNTHESIS XCT 11

new

PRECISA IN VELOCITÀ | GUIDAGE PRECIS A HAUTE VITESSE

HUB
INDUSTRY NINE HYDRA HUB

ENGAGEMENT
0.52" QUICK ENGAGEMENT / SIX PAWLS

SPOKES
SAPIM CX-RAY (FRONT)
SAPIM CX-RAY (REAR)



FRONT



REAR

COMPLIANT FRONT WHEEL

SPOKE COUNT: 28 INNER RIM WIDTH: 26.5

STIFF REAR WHEEL

SPOKE COUNT: 32 INNER RIM WIDTH: 24.5

OUTER RIM WIDTH

OUTER RIM WIDTH FRONT: 31.1 MM OUTER RIM WIDTH REAR: 29.5 MM

ARTICLE	UPC	NEW	MODEL	DIAMETER	HUB	DRIVER BODY	FRONT AXLE	REAR AXLE	RIM	WEIGHT	PRICE (€)
16967	641300169679	new		29" Front	Boost i9	-	15x110mm	-	Carbon Premium	700g	1000
16968	641300169686	new	Synthesis XCT 11	29" Rear	Boost i9	XD	-	148x12mm	Carbon Premium	970g	1400
16970	641300169709	new		29" Rear	Boost i9	Shimano MS	-	148x12mm	Carbon Premium	970g	1400



CARBON SINGLE WHEEL SYNTHESIS E 11

new

CONTROLLO E STABILITÀ PER L'ENDURO | CONTRÔLE ET STABILITÉ EN PRATIQUE ENDURO

HUB
INDUSTRY NINE HYDRA HUB

ENGAGEMENT
0.52" QUICK ENGAGEMENT / SIX PAWLS

SPOKES
SAPIM CX-RAY (FRONT)
SAPIM CX-SPRINT (REAR)



FRONT



REAR

COMPLIANT FRONT WHEEL

SPOKE COUNT: 28 INNER RIM WIDTH: 31.5

STIFF REAR WHEEL

SPOKE COUNT: 32 INNER RIM WIDTH: 29.5

OUTER RIM WIDTH

OUTER RIM WIDTH FRONT: 37.5 MM OUTER RIM WIDTH REAR: 36.5 MM

ARTICLE	UPC	NEW	MODEL	DIAMETER	HUB	DRIVER BODY	FRONT AXLE	REAR AXLE	RIM	WEIGHT	PRICE (€)
16971	641300169716	new	Synthesis E 11	27.5" Front	Boost i9	-	15x110mm	-	Carbon Premium	830g	1000
16972	641300169723	new		27.5" Rear	Boost i9	XD	-	148x12mm	Carbon Premium	1025g	1400
16974	641300169747	new		27.5" Rear	Boost i9	Shimano MS	-	148x12mm	Carbon Premium	1025g	1400
16975	641300169754	new		27.5" Rear	Super Boost i9	XD	-	157x12mm	Carbon Premium	1035g	1400
16977	641300169778	new		27.5" Rear	Super Boost i9	Shimano MS	-	157x12mm	Carbon Premium	1035g	1400
16978	641300169785	new		29" Front	Boost i9	-	15x110mm	-	Carbon Premium	864g	1000
16979	641300169792	new		29" Rear	Boost i9	XD	-	148x12mm	Carbon Premium	1060g	1400
16981	641300169815	new		29" Rear	Boost i9	Shimano MS	-	148x12mm	Carbon Premium	1060g	1400
16982	641300169822	new		29" Rear	Super Boost i9	XD	-	157x12mm	Carbon Premium	1070g	1400
16984	641300169846	new		29" Rear	Super Boost i9	Shimano MS	-	157x12mm	Carbon Premium	1070g	1400



CARBON SINGLE WHEEL

SYNTHESIS E i9 1/1

new

CONTROLLO E STABILITÀ PER L'ENDURO | CONTRÔLE ET STABILITÉ EN PRATIQUE ENDURO

HUB
INDUSTRY NINE 1/1

ENGAGEMENT
4"

SPOKES
SAPIM D-LIGHT (FRONT)
SAPIM RACE (REAR)



FRONT



REAR

COMPLIANT FRONT WHEEL

SPOKE COUNT: 28
INNER RIM WIDTH: 31.5

STIFF REAR WHEEL

SPOKE COUNT: 32
INNER RIM WIDTH: 29.5

OUTER RIM WIDTH

OUTER RIM WIDTH FRONT: 37.5 MM
REAR: 36.5 MM

ARTICLE	UPC	NEW	MODEL	DIAMETER	HUB	DRIVER BODY	FRONT AXLE	REAR AXLE	RIM	WEIGHT	PRICE (€)
17010	641300170101	new	Synthesis E i9 1/1	27.5" Front	Boost i9 1/1	-	15x110mm	-	Carbon Premium	860g	850
17011	641300170118	new		27.5" Rear	Boost i9 1/1	XD	-	148x12mm	Carbon Premium	1035g	1150
17013	641300170132	new		27.5" Rear	Boost i9 1/1	Shimano MS	-	148x12mm	Carbon Premium	1035g	1150
17014	641300170149	new		27.5" Rear	Super Boost i9 1/1	XD	-	157x12mm	Carbon Premium	1045g	1150
17016	641300170163	new		27.5" Rear	Super Boost i9 1/1	Shimano MS	-	157x12mm	Carbon Premium	1045g	1150
17017	641300170170	new		29" Front	Boost i9 Hydra	-	15x110mm	-	Carbon Premium	869g	850
17018	641300170187	new		29" Rear	Boost i9 Hydra	XD	-	148x12mm	Carbon Premium	1145g	1150
17019	641300170194	new		29" Rear	Boost i9 Hydra	Shimano HG	-	148x12mm	Carbon Premium	1145g	1150
17020	641300170200	new		29" Rear	Boost i9 Hydra	Shimano MS	-	148x12mm	Carbon Premium	1145g	1150
17021	641300170217	new		29" Rear	Super Boost i9 1/1	XD	-	157x12mm	Carbon Premium	1153g	1150
17023	641300170231	new		29" Rear	Super Boost i9 1/1	Shimano MS	-	157x12mm	Carbon Premium	1153g	1150



CARBON SINGLE WHEEL
SYNTHESIS XCT CB RATCHET

new

PRECISA IN VELOCITÀ | GUIDAGE PRECIS A HAUTE VITESSE

HUB
 CB RATCHET

ENGAGEMENT
 10°

SPOKES
 SAPIM D-LIGHT



FRONT



REAR

COMPLIANT FRONT WHEEL

SPOKE COUNT: 28 INNER RIM WIDTH: 26.5

STIFF REAR WHEEL

SPOKE COUNT: 32 INNER RIM WIDTH: 24.5

OUTER RIM WIDTH

OUTER RIM WIDTH FRONT: 31.1 MM OUTER RIM WIDTH REAR: 29.5 MM

ARTICLE	UPC	NEW	MODEL	DIAMETER	HUB	DRIVER BODY	FRONT AXLE	REAR AXLE	RIM	WEIGHT	PRICE (€)
16985	641300169853	new	Synthesis XCT CB Ratchet	29" Front	Boost CB Ratchet	-	15x110mm	-	Carbon Premium	735g	750
16986	641300169860	new		29" Rear	Boost CB Ratchet	XD	-	148x12mm	Carbon Premium	1014g	850
16988	641300169884	new		29" Rear	Boost CB Ratchet	Shimano MS	-	148x12mm	Carbon Premium	1014g	850



CARBON SINGLE WHEEL
SYNTHESIS E CB RATCHET

new

PRECISA IN VELOCITÀ | GUIDAGE PRECIS A HAUTE VITESSE

HUB
CB RATCHET

ENGAGEMENT
10°

SPOKES
SAPIM D-LIGHT (FRONT)
SAPIM RACE (REAR)



FRONT



REAR

COMPLIANT FRONT WHEEL

STIFF REAR WHEEL

OUTER RIM WIDTH

SPOKE COUNT: 28
INNER RIM WIDTH: 31.5

SPOKE COUNT: 32
INNER RIM WIDTH: 29.5

OUTER RIM WIDTH FRONT: 37.5 MM
REAR: 36.5 MM

ARTICLE	UPC	NEW	MODEL	DIAMETER	HUB	DRIVER BODY	FRONT AXLE	REAR AXLE	RIM	WEIGHT	PRICE (€)
16989	641300169891	new	Synthesis E CB Ratchet	27.5" Front	Boost CB Ratchet	-	15x110mm	-	Carbon Premium	865g	750
16990	641300169907	new		27.5" Rear	Boost CB Ratchet	XD	-	148x12mm	Carbon Premium	1069g	850
16992	641300169921	new		27.5" Rear	Boost CB Ratchet	Shimano MS	-	148x12mm	Carbon Premium	1069g	850
16993	641300169938	new		29" Front	Boost CB Ratchet	-	15x110mm	-	Carbon Premium	899g	750
16994	641300169945	new		29" Rear	Boost CB Ratchet	XD	-	148x12mm	Carbon Premium	1104g	850
16996	641300169969	new		29" Rear	Boost CB Ratchet	Shimano MS	-	148x12mm	Carbon Premium	1104g	850



CARBON SINGLE WHEEL SYNTHESIS E-BIKE

new

COSTRUITE PER E-MTB | CONSTRUIT POUR E-MTB

HUB
CB RATCHET

ENGAGEMENT
10°

SPOKES
SAPIM E-LIGHT (FRONT)
SAPIM STRONG (REAR)



FRONT
SIZES: 27.5 - 29



REAR
SIZE: 27.5+

COMPLIANT FRONT WHEEL

SPOKE COUNT: 28
INNER RIM WIDTH: 31.5

STIFF REAR WHEEL

SPOKE COUNT: 32
INNER RIM WIDTH: 31.5

OUTER RIM WIDTH

OUTER RIM WIDTH FRONT: 37.5 MM
REAR: 36.5 MM

ARTICLE	UPC	NEW	MODEL	DIAMETER	HUB	DRIVER BODY	FRONT AXLE	REAR AXLE	RIM	WEIGHT	PRICE (€)
16997	641300169976	new	Synthesis E-Bike	27.5" Front	Boost CB Ratchet	-	15x110mm	-	Carbon Premium	912g	750
16998	641300169983	new		27.5" Rear	Boost CB Ratchet	XD	-	148x12mm	Carbon Premium	1179g	850
16999	641300169990	new		27.5" Rear	Boost CB Ratchet	Shimano HG	-	148x12mm	Carbon Premium	1178g	850
17000	641300170002	new		27.5" Rear	Boost CB Ratchet	Shimano MS	-	148x12mm	Carbon Premium	1178g	850
17002	641300170026	new		29" Front	Boost CB Ratchet	-	15x110mm	-	Carbon Premium	947g	750
17003	641300170033	new		29" Rear	Boost CB Ratchet	XD	-	148x12mm	Carbon Premium	1197g	850
17004	641300170040	new		29" Rear	Boost CB Ratchet	Shimano HG	-	148x12mm	Carbon Premium	1207g	850
17005	641300170057	new		29" Rear	Boost CB Ratchet	Shimano MS	-	148x12mm	Carbon Premium	1207g	850



CARBON SINGLE WHEEL
SYNTHESIS GRAVEL CARBON

DOVE IL COMFORT INCONTRA LA PERFORMANCE | QUAND LE CONFORT RENCONTRE LA PERFORMANCE

HUB
 SYNTHESIS RATCHET

ENGAGEMENT
 10°

SPOKES
 SAPIM D-LIGHT

SIZES
 700 C / 650 B

WEIGHT
 700 C: 1544g / 650 B: 1517G

TUBELESS READY

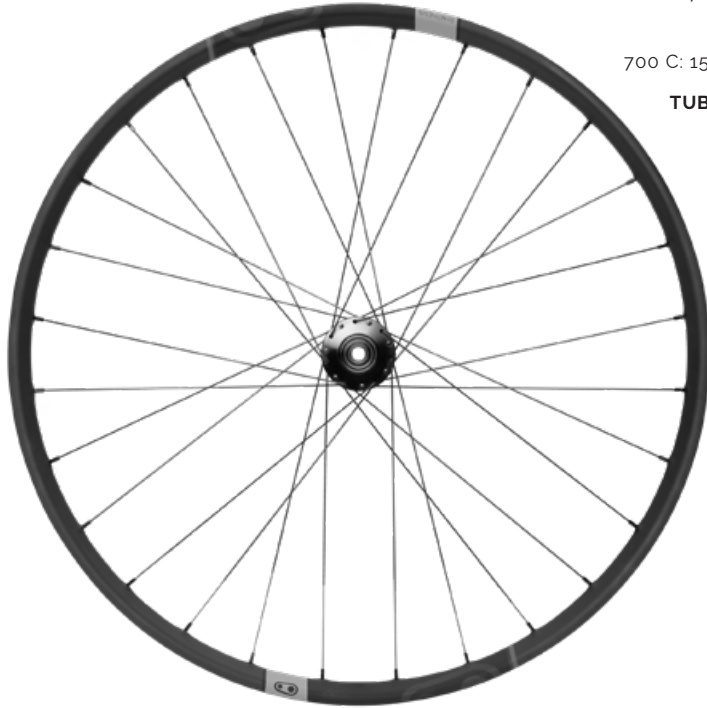

FRONT



REAR

FRONT WHEEL

SPOKE COUNT: 28 INNER RIM WIDTH: 26.5

REAR WHEEL

SPOKE COUNT: 28 INNER RIM WIDTH: 26.5

ARTICLE	UPC	MODEL	DIAMETER	HUB	DRIVER BODY	FRONT AXLE	REAR AXLE	RIM	WEIGHT	PRICE (€)
16825	641300168252	Synthesis Gravel Carbon	700C Front	CB Ratchet	-	12x100mm	-	26.5	730g	750
16826	641300168269		700C Rear	CB Ratchet	XDR	-	142x12mm	26.5	836g	850
16827	641300168276		700C Rear	CB Ratchet	HGR	-	142x12mm	26.5	846g	850
16828	641300168283		650B Front	CB Ratchet	-	12x100mm	-	26.5	695g	750
16829	641300168290		650B Rear	CB Ratchet	XDR	-	142x12mm	26.5	825g	850
16830	641300168306		650B Rear	CB Ratchet	HGR	-	142x12mm	26.5	835g	850



ALLOY SINGLE WHEEL SYNTHESIS XCT ALLOY

PRECISA IN VELOCITÀ | GUIDAGE PRECIS A HAUTE VITESSE

HUB
SYNTHESIS STANDARD HUB

ENGAGEMENT
4"

SPOKES
SAPIM D-LIGHT (FRONT)
SAPIM RACE (REAR)



FRONT



REAR

COMPLIANT FRONT WHEEL

SPOKE COUNT: 28 INNER RIM WIDTH: 26.5

STIFF REAR WHEEL

SPOKE COUNT: 32 INNER RIM WIDTH: 24.5

ARTICLE	UPC	MODEL	DIAMETER	HUB	DRIVER BODY	FRONT AXLE	REAR AXLE	RIM	WEIGHT	PRICE (€)
16418	641300164186	Synthesis XCT Alloy	29" Front	Boost	-	110x15mm	-	26.5	841g	240
16419	641300164193		29" Rear	Boost	XD	-	148x12mm	24.5	998g	360
16421	641300164216		29" Rear	Boost	Shimano MS	-	148x12mm	24.5	998g	360



ALLOY SINGLE WHEEL
SYNTHESIS E ALLOY

CONTROLLO E STABILITÀ PER L'ENDURO | CONTRÔLE ET STABILITÉ EN PRATIQUE ENDURO

HUB
SYNTHESIS STANDARD HUB

ENGAGEMENT
4°
17°

SPOKES
SAPIM D-LIGHT (FRONT)
SAPIM RACE (REAR)



FRONT



REAR

COMPLIANT FRONT WHEEL

SPOKE COUNT: 28 INNER RIM WIDTH: 31.5

STIFF REAR WHEEL

SPOKE COUNT: 32 INNER RIM WIDTH: 29.5

ARTICLE	UPC	MODEL	DIAMETER	HUB	DRIVER BODY	FRONT AXLE	REAR AXLE	RIM	WEIGHT	PRICE (€)
16406	641300164063	Synthesis Enduro Alloy	27.5" Front	Boost	-	110x15mm	-	31.5	877g	240
16407	641300164070		27.5" Rear	Boost	XD	-	148x12mm	29.5	1062g	360
16409	641300164094		27.5" Rear	Boost	Shimano MS	-	148x12mm	29.5	1062g	360
16410	641300164100		29" Front	Boost	-	110x15mm	-	31.5	902g	240
16411	641300164117		29" Rear	Boost	XD	-	148x12mm	29.5	1095g	360
16413	641300164131		29" Rear	Boost	Shimano MS	-	148x12mm	29.5	1095g	360



ELECTRIC

ALLOY SINGLE WHEEL SYNTHESIS E-BIKE ALLOY

COSTRUITA PER E-MTB | CONSTRUIT POUR E-MTB

HUB

SYNTHESIS STANDARD HUB

ENGAGEMENT

17"

SPOKES

S APIM E-LIGHT (FRONT)

S APIM STRONG (REAR)



FRONT

SIZES: 27.5 - 29



REAR

SIZE: 27.5*

COMPLIANT FRONT WHEEL

SPOKE COUNT:
28

INNER RIM
WIDTH:
31.5

STIFF REAR WHEEL

SPOKE COUNT:
32

INNER RIM
WIDTH:
31.5

COMPLIANT FRONT WHEEL

SPOKE COUNT:
28

INNER RIM
WIDTH:
35.5

STIFF REAR WHEEL

SPOKE COUNT:
32

INNER RIM
WIDTH:
35.5

ARTICLE	UPC	NEW	MODEL	DIAMETER	HUB	DRIVER BODY	FRONT AXLE	REAR AXLE	RIM	WEIGHT	PRICE (€)
16422*	641300164223			27.5" Plus/Front	Boost	-	110x15mm	-	35.5	928g	300
16431	641300164315	new		27.5" Rear	Boost	XD	-	148x12mm	31.5	1174g	400
16432	641300164322	new		27.5" Rear	Boost	Shimano HG	-	148x12mm	31.5	1174g	400
16433	641300164339	new	Synthesis E-MTB Alloy	27.5" Rear	Boost	Shimano MS	-	148x12mm	31.5	1174g	400
16426	641300164261			29" Front	Boost	-	110x15mm	-	31.5	980g	300
16427	641300164278			29" Rear	Boost	XD	-	148x12mm	31.5	1238g	400
16429	641300164292			29" Rear	Boost	Shimano MS	-	148x12mm	31.5	1238g	400

(*) Fino ad esaurimento scorte | Jusqu'à épuisement des stocks



ALLOY SINGLE WHEEL
SYNTHESIS GRAVEL ALLOY

DOVE IL COMFORT INCONTRA LA PERFORMANCE | QUAND LE CONFORT RENCONTRE LA PERFORMANCE

HUB
 SYNTHESIS STANDARD

ENGAGEMENT
 17°

SPOKES
 SAPIM D-LIGHT

SIZES
 700 C / 650 B

WEIGHT
 700 C: 1917g / 650 B: 1769g

TUBELESS READY

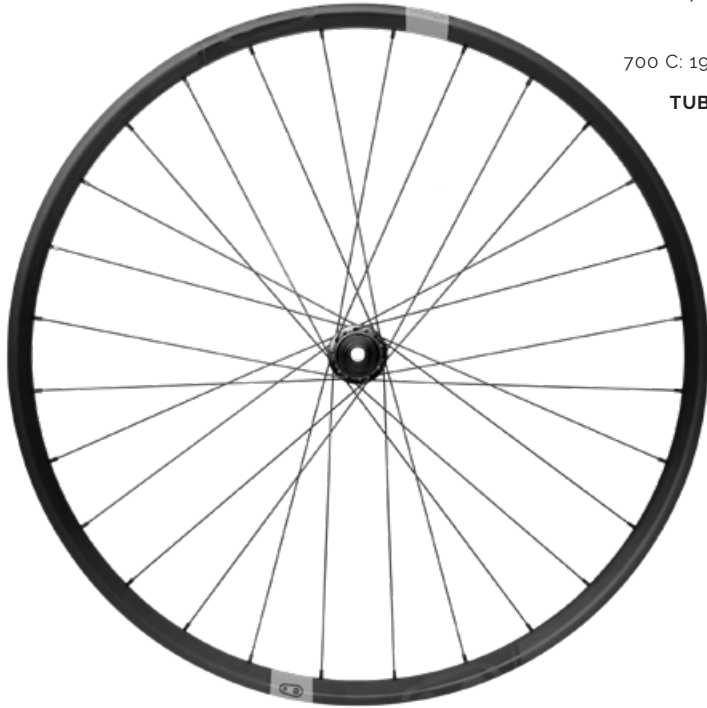

FRONT



REAR

FRONT WHEEL

SPOKE COUNT: 28 INNER RIM WIDTH: 26.5

REAR WHEEL

SPOKE COUNT: 28 INNER RIM WIDTH: 26.5

ARTICLE	UPC	MODEL	DIAMETER	HUB	DRIVER BODY	FRONT AXLE	REAR AXLE	RIM	WEIGHT	PRICE (€)
16831	641300168313	Synthesis Gravel Alloy	700C Front	CB Ratchet	-	12x100mm	-	26.5	869g	240
16832	641300168320		700C Rear	CB Ratchet	XDR	-	142x12mm	26.5	1050g	360
16833	641300168337		700C Rear	CB Ratchet	HG	-	142x12mm	26.5	1058g	360
16834	641300168344		650B Front	CB Ratchet	-	12x100mm	-	26.5	792g	240
16835	641300168351		650B Rear	CB Ratchet	XDR	-	142x12mm	26.5	977g	360
16836	641300168368		650B Rear	CB Ratchet	HG	-	142x12mm	26.5	985g	360

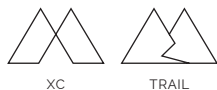

ALLOY WHEELSETS

COBALT 2

COBALT 2
ALUMINIUM

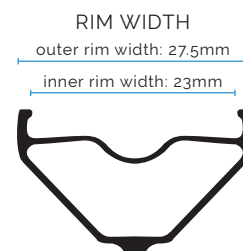

WHEEL
ACCESSORIES



XD DRIVER BODY
SYNTHESIS & ALLOY WHEELSETS

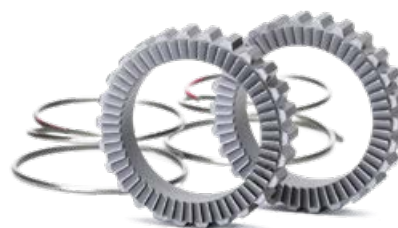

new

RATCHET HUBS 6.6° ENGAGEMENT UPGRADE KIT
UPGRADES RATCHED HUBS ENGAGEMENT FROM 10 TO 6 DEGREES

ALLOY WHEELSETS										
ARTICLE	UPC	MODEL	DIAMETER	HUB	DRIVER BODY	FRONT AXLE	REAR AXLE	COLOR	WEIGHT	PRICE (€)
16140*	641300161406	Cobalt 2	29"	Standard	Shimano HG	100x15 mm	142x12 mm	Black/Grey	1735g	600
WHEEL ACCESSORIES										
ARTICLE	UPC	NEW	COLLECTION	MODEL KIT	PRICE (€)					
15538	641300155382		Wheel	Wheel Synthesis and Alloy XD Driver Body for: Level 2,3 E 11 (from Range 2017)	100					
17045	641300170453	new	Accessories	Wheel Pawl Ring 54t 2pcs & Spring 2pcs Ratchet Gravel Hubs Rear	130					

(*) Fino ad esaurimento scorte | Jusqu'à épuisement des stocks





DROPPER SEATPOST

HIGHLINE DROPPER SEATPOST

IL NOSTRO REGGISSELLA TELESCOPICO CON PESO PIU' CONTENUTO,
GRAZIE AI SUOI MATERIALI PREMIUM CHE RISPARMIANO GRAMMI.

LA PLUS LÉGÈRE DE NOS TIGES DE SELLE RÉALISÉE À PARTIR DE MATÉRIAUX
DE HAUTE QUALITÉ POUR UN GAIN DE POIDS MAXIMUM.



DROPPER SEATPOST

HIGHLINE 11 DROPPER SEATPOST

GUARNIZIONI PREMIUM TRELLEBORG, ESCLUSIVI CUSCINETTI E CALOTTE IGUS, CAVO JAGWIRE & UNA CARTUCCIA IDRAULICA INDIPENDENTE CHE OFFRE QUALITÀ E AFFIDABILITÀ INDISCUSSE IN QUESTO SETTORE.

JOINT D'ÉTANCHÉITÉ PREMIUM TRELLEBORG, ROULEMENTS ET CLES EXCLUSIFS IGUS, TRANSMISSION JAGWIRE & ET UNE CARTOUCHE HYDRAULIQUE AUTONOME PROCURENT UNE QUALITÉ ET UNE FIABILITÉ DE POINTE.



LOW STACK HEIGHT
47 mm

QUICK-SADDLE
INSTALLATION SYSTEM

CARBON QUILL

IFP HYDRAULIC
CARTRIDGE

QUICK-CONNECT LINEAR
PULL ACTUATOR

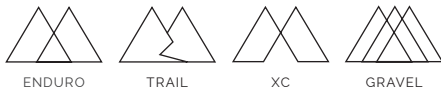

HIGHLINE 11
100mm
125mm
150mm
170mm



ARTICLE	UPC	MODEL	TRAVEL	DIAMETER	LENGTH	WEIGHT*	PRICE (€)
16481	641300164810	Highline 11* (No Remote Lever included)	100mm	30.9	367mm	398g	400
16482	641300164827			31.6		418g	400
16483	641300164834		125mm	30.9	417mm	429g	400
16484	641300164841			31.6		449g	400
16485	641300164858		150mm	30.9	467mm	465g	400
16486	641300164865			31.6		486g	400
16487	641300164872		170mm	30.9	507mm	488g	400
16488	641300164889			31.6		509g	400

(*) Il peso include solo il reggisella. La guaina aggiunge tra i 20 e i 60 grammi in base alla lunghezza.
Le poids comprend seulement la tige de selle. Le logement extérieur ajoute 25-60 g en fonction de la longueur.

DROPPER SEATPOST

HIGHLINE 7 & 3 DROPPER SEATPOST



7

HIGHLINE 7
100mm
125mm
150mm
170mm
200mm

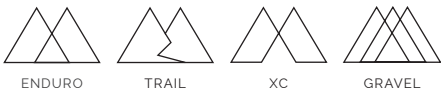

3

HIGHLINE 3
80mm
100mm
125mm
150mm
170mm
200mm





DROPPER SEATPOST

HIGHLINE XC/GRAVEL DROPPER SEATPOST

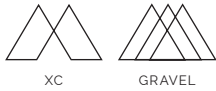

HIGHLINE XC/GRAVEL Ø 27,2mm
 60mm
 80mm
 100mm
 125mm



ARTICLE	UPC	MODEL	TRAVEL	DIAMETER	LENGTH	WEIGHT*	PRICE (€)
16378	641300163783	Highline 7 (No Remote Lever included)	100mm	30.9	367mm	474g	300
16379	641300163790			31.6		490g	300
16380	641300163806		125mm	30.9	417mm	515g	300
16381	641300163813			31.6		525g	300
16382	641300163820		150mm	30.9	467mm	550g	300
16383	641300163837			31.6		572g	300
16384	641300163844		170mm	30.9	507mm	583g	300
16385	641300163851			31.6		604g	300
16621	641300166210	200mm	31.6	567mm	679g	300	
16501	641300165015	Highline 3 (No Remote Lever included)	80mm	30.9	418mm	540g	200
16502	641300165022			31.6		564g	200
16370	641300163707		100mm	30.9	370mm	484g	200
16371	641300163714			31.6		503g	200
16469	641300164698		125mm	34.9	421mm	603g	200
16372	641300163721			30.9		525g	200
16373	641300163738		150mm	31.6	469mm	545g	200
16471	641300164711			34.9		645g	200
16374	641300163745	170mm	30.9	509mm	565g	200	
16375	641300163752		31.6		587g	200	
16472	641300164728	200mm	34.9	569mm	699g	200	
16376	641300163769		30.9		585g	200	
16377	641300163776	200mm	31.6	569mm	609g	200	
16473	641300164735		34.9		735g	200	
16523	641300165237	200mm	31.6	569mm	686g	200	
16489	641300164896	Highline XC/Gravel (No Remote Lever included)	60mm short	27.2	297mm	369g	250
16490	641300164902		60mm long	27.2	387mm	410g	250
16500	641300165008		80mm	27.2	407mm	434g	250
16468	641300164681		100mm	27.2	427mm	459g	250
16470	641300164704		125mm	27.2	452mm	467g	250

(*) Il peso include solo il reggisella. La guaina aggiunge tra i 20 e i 60 grammi in base alla lunghezza.
 Le poids comprend seulement la tige de selle. Le logement extérieur ajoute 25-60 g en fonction de la longueur.

HIGHLINE REMOTE KIT

WORLD'S MOST ERGONOMIC REMOTE

IL CONTROLLO REMOTO DELL'HIGHLINE È CARATTERIZZATO DA UN SISTEMA DI REGOLAZIONE SFERICO, CON UNA CAPACITÀ DI ROTAZIONE QUASI COMPLETA E LA POSSIBILITÀ DI REGOLARE L'INCLINAZIONE PER UNA PERFETTA ERGONOMIA.

LA COMMANDE DE L'HIGHLINE SE CARACTÉRISE PAR UN SYSTÈME D'AJUSTEMENT SPHÉRIQUE UNIQUE EN SON GENRE. IDÉALE SUR LE PLAN ERGONOMIQUE, ELLE PERMET À CHAQUE PILOTE DE LA POSITIONNER SUR LE CINTRE À LA POSITION PARFAITE.



HIGHLINE EVO
FLATBAR DROPPER POST REMOTE KIT
MATCHMAKER



HIGHLINE EVO
FLATBAR DROPPER POST REMOTE KIT
22.2 CLAMP



HIGHLINE EVO
FLATBAR DROPPER POST REMOTE KIT
I-SPEC EV



HIGHLINE
FLATBAR DROPPER POST REMOTE KIT
22.2 CLAMP



HIGHLINE
DROPBAR DROPPER POST REMOTE KIT V2

ARTICLE	EX CODE	UPC	MODEL	PRICE (€)
16754		641300167545	Highline EVO - Flatbar Dropper Post Remote Kit 22.2 Clamp	70
16755		641300167552	Highline EVO - Flatbar Dropper Post Remote Kit Matchmaker	70
16756		641300167569	Highline EVO - Flatbar Dropper Post Remote Kit I-Spec Ev	70
16066		641300160669	Highline Remote Kit 22.2 Clamp	60
16824	16566	641300168245	Highline Dropbar Remote Kit V2	50



GRIPS COBALT

COBALT
GRIPS

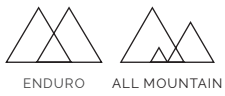

IODINE

IODINE
GRIP



ARTICLE	UPC	MODEL	COLOR	material	WIDTH	WEIGHT	PRICE (€)
15279*	641300152794		Silver				30
14918*	641300149183	Cobalt Grips	Gold	High Density Foam	130mm	67g	30
14919*	641300149190		Red				30
14920	641300149206	Iodine Grip	Black	Krayton Rubber	130mm	95g	30

(*) Fino ad esaurimento scorte | Jusqu'à épuisement des stocks



TOOLS

LA LINEA DI TOOLS CRANKBROTHERS È STATA PROGETTATA PER SODDISFARE LE ESIGENZE DI OGNI RIDER, SIA CHE PREFERISCA PORTARE I MULTITOOL NELLO ZAINO O IN TASCA, SIA CHE PREFERISCA AVERLI INSTALLATI SULLA BICI PER NON DIMENTICARLI A CASA. DAI CLASSICI M-TOOLS, AI LEGGERI F-TOOLS, FINO ALLA NUOVA LINEA SOS, OGNI RIDER POTRÀ TROVARE LA SOLUZIONE PIÙ ADATTA ALLE PROPRIE NECESSITÀ.

LA GAMME D'OUTILS CRANKBROTHERS EST CONÇUE POUR RÉPONDRE AUX BESOINS DE TOUS LES CYCLISTES, QU'ILS LES TRANSPORTENT DANS UN SAC À DOS OU UNE POCHE OU QU'ILS LES MONTENT SUR LE VÉLO POUR NE PAS LES OUBLIER À LA MAISON. CHAQUE RIDER PEUT TROUVER LA SOLUTION LA MIEUX ADAPTÉE À SES BESOINS, DES OUTILS M CLASSIQUES AUX OUTILS F LÉGERS, EN PASSANT PAR LA NOUVELLE LIGNE SOS.



S.O.S TOOLS

A COMPLETE SOLUTION FOR CYCLING'S MOST COMMON MECHANICALS

RANGE OVERVIEW



TT17 TWIN TUBE TOOL KIT

BC2 BOTTLE CAGE+

BC18 BOTTLE CAGE TOOL KIT

TS2 TUBE STASH+

TS18 TUBE STASH TOOL KIT

UNIQUE FEATURES



MULTI-TOOL S.O.S.

- La nostra interpretazione versatile del multi-tool può essere utilizzata come un'impugnatura a T, un cacciavite in linea o come un tipico set di chiavi a L.
- Si può aumentare un po' la leva estendendo l'attrezzo con il tubo in lega del tool o lasciandolo attaccato allo smagliacatena CO2.
- Porta con te una maglia catena di ricambio grazie al supporto magnetico.

S.O.S. MULTI-TOOL

- Notre version polyvalente du multi-tool peut être utilisé comme un manche en T, un tournevis en ligne, ou d'un ensemble typique d'outils à clé en L.
- Obtenez un effet de levier supplémentaire en prolongeant l'outil à l'aide du tool tube en alliage ou en le laissant attaché au dérive chaîne CO2.
- Stockez un maillon de chaîne de rechange grâce au support magnétique.



SMAGLIA-CATENA S.O.S. CO2

- Questo attrezzo è utile per gonfiare gli pneumatici, per serrare le valvole e i raggi allentati. La leva caccia-copertoni diventa una robusta impugnatura per riparare la catena.

S.O.S. CO2 DERIVE CHAINE

- Cet outil permet de gonfler les pneus, de desserrer les valves et les rayons. La fixation du démonte-pneu sert de poignée solide pour réparer les chaînes.



GLI ATTREZZI ADATTI PER LE GOMME

- Capaci leve per gli pneumatici e tappi per le gomme in abbondanza assicurano di avere gli attrezzi necessari.
- Aria compressa! La maggior parte dei Tool S.O.S. può alloggiare una piccola/grande cartuccia di CO2 o una pompa Klic HV di Crankbrothers.

DES OUTILS APPROPRIÉS POUR LES PNEUS

- Les démonte-pneus et les mèches garantissent que vous aurez les outils nécessaires.
- Gonflez ! La plupart des outils S.O.S. peuvent contenir une petite/grande cartouche de CO2 ou une pompe Crankbrothers Klic HV.



SPAZIO PER I RICAMBI (O PER QUELLO CHE VUOI)

- I Tool Kit TS2 Tube Stash+ e il TS18 Tube Stash si distinguono per la versatile chiusura in velcro.
- Il tubo di stoccaggio è incluso nel modello di Tool Kit TT17 Twin Tube.

UN ENDROIT POUR TRANSPORTER DES PIÈCES DE RECHANGE (OU AUTRE)

- Les kits d'outils TS2 Tube Stash+ et TS18 Tube Stash sont dotés d'une sangle polyvalente.
- Le tube de rangement est inclus dans le kit d'outils TT17 Twin.

S.O.S. TOOL FUNCTION OVERVIEW

	HEX 2	HEX 2.5	HEX 3	HEX 4	HEX 5	HEX 6	HEX 8	FLAT	TORX 10	TORX 25	TIRE PLUG TECH	TIRE PLUGS	TIRE LEVER	CHAIN TOOL	#0, 1, 2 SPOKE WRENCH	VALVE CORE TOOL	CO2 HEAD + STORAGE
TT17 Twin Tube Tool Kit	●	●	●	●	●	●	●	●		●	●	●	●	●	●	●	●
BC2 Bottle Cage+											●	●	●				
BC18 Bottle Cage Tool Kit	●	●	●	●	●	●	●	●	●	●	●	●	●	●	●	●	●
TS2 Tube Stash+											●	●	●				
TS18 Tube Stash Tool Kit	●	●	●	●	●	●	●	●	●	●	●	●	●	●	●	●	●

S.O.S TOOLS



S.O.S. TT17 TWIN TUBE TOOL KIT



S.O.S. BC18 BOTTLE CAGE TOOL KIT



S.O.S. TS18 TUBE STASH TOOL KIT



LEVER FRONT LEVER BACK



S.O.S. BC2 BOTTLE CAGE+



S.O.S. TS2 TUBE STASH+

ARTICLE	UPC	MODEL	WEIGHT	PRICE (€)
16774	641300167743	tool S.O.S. TT17 twin tube tool kit	247g	120
16776	641300167767	tool S.O.S. BC18 bottle cage kit	247g	100
16778	641300167781	tool S.O.S. TS18 tube stash tool kit	229g	90
16775	641300167750	tool S.O.S. BC2 bottle cage +	73g	40
16777	641300167774	tool S.O.S. TS2 tube stash +	53g	30



S.O.S TOOLS

BC18 BOTTLE CAGE TOOL KIT

QUALE PARTE DELLA NOSTRA NUOVA GAMMA DI TOOL KIT S.O.S (SAVE OUR SHRED), IL BC18 OFFRE UN AFFIDABILE SUPPORTO MECCANICO IN BICI PER QUEI MOMENTI IMPREVISTI SUI TRAIL, UNITO A UN PORTABORRACCIA REVERSIBILE PER SODDISFARE LE TUE ESIGENZE DI IDRATAZIONE DURANTE LA CORSA. PROGETTATO PER INTEGRARSI COMPLETAMENTE AL TELAIO DELLA BICICLETTA, QUESTO KIT TI GARANTISCE UN FACILE ACCESSO AGLI STRUMENTI ESSENZIALI PER RIPARAZIONI RAPIDE E ASSISTENZA SULLA STRADA, IN MODO CHE TU POSSA MANTENERE IL FLOW E CONTINUARE A PEDALARE.

FAISANT PARTIE DE NOTRE NOUVELLE GAMME D'OUTILS S.O.S (SAVE OUR SHRED), LE BC18 OFFRE UNE ASSISTANCE MÉCANIQUE FIABLE EMBARQUÉE POUR LES MOMENTS INATTENDUS SUR LES SENTIERS, COMBINÉE À UN PORTE-BIDON RÉVERSIBLE POUR RÉPONDRE À VOS BESOINS D'HYDRATATION À MI-PARCOURS. CONÇU POUR S'INTÉGRER PARFAITEMENT AU CADRE DE VOTRE VÉLO, CE KIT GARANTIT UN ACCÈS FACILE AUX OUTILS ESSENTIELS POUR LES RÉPARATIONS RAPIDES ET L'ASSISTANCE SUR LES SENTIERS, AFIN QUE VOUS PUISSIEZ RESTER DANS LE FLOW ET CONTINUER À PÉDALER.



FEATURES

- Portaborraccia reversibile con accesso da sinistra o destra
- Chiavi a brugola 2, 2.5, 3, 4, 5, 6 + adattatore da 8mm
- Chiavi torx T25 e T10
- Cacciavite a taglio
- Strumento per riparazione pneumatici + 4 tappi
- Leva caccia-copertoni
- Smaglia-catena
- Chiavi per raggi 0, 1, 2
- Strumento per il nucleo valvola
- Testina CO2
- Tubo di stoccaggio degli attrezzi
- Può contenere una maglia catena di ricambio + una cartuccia CO2 da 16g/20g/25g o una pompa a mano Klic HV, vendute separatamente.

- Porte-bidon réversible à gauche ou à droite
- Clé allen hexagonale 2, 2.5, 3, 4, 5, 6 + adaptateur 8mm
- Outils torx T25 et T10
- Tournevis plat
- Outil pour reboucher les pneus + 4 bouchons
- Démonte-pneu
- Dérive chaîne
- Clé à rayons 0, 1, 2
- Outil de valve
- Embout CO2
- Tube de rangement
- Contient un maillon de chaîne de recharge + une cartouche de CO2 de 16g/20g/25g ou une pompe à main Klic HV, vendue séparément.



TOOLS



M20



M19



M17



M13



M10

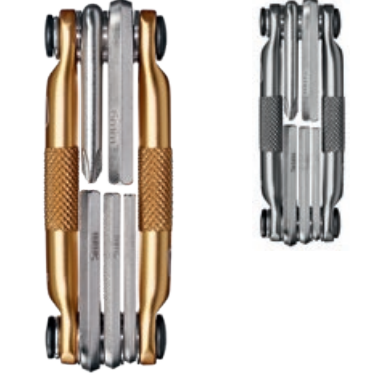

M5

ARTICLE	UPC	MODEL	COLOR	WEIGHT	PRICE (€)
16403	641300164032	Multi 20	Matte Black	203g	40
16402	641300164025		Nickel		40
16405	641300164056		Gold		40
16404	641300164049		Matte Black/Red		40
11465	641300352194	Multi 19	Nickel	175g	38
10758	641300351197		Gold		38
10752	641300350176	Multi 17	Nickel	168g	30
10755	641300351173		Gold		30
16399	641300163998	Multi 13	Matte Black	164g	28
16398	641300163981		Nickel		28
16401	641300164018		Gold		28
16400	641300164001		Matte Black/Red		28
10747	641300350107	Multi 10	Nickel	124g	20
10750	641300351104		Gold		20
10743	641300350053	Multi 5	Nickel	85g	15
10745	641300351050		Gold		15



TOOLS



F16

F11



F15

F10+

CIGAR TOOL

SLIDER TIRE LEVER KIT

TOOL BITS

	HEX 2	HEX 2.5	HEX 3	HEX 4	HEX 5	HEX 6	HEX 8	PHIL #1	PHIL #2	FLAT	TORX 10	TORX 25	OPEN WRENCH 8MM	OPEN WRENCH 10MM	ROTOR ALIGNMENT	CHAIN TOOL	SPOKE WRENCH	VALVE CORE TOOL	TIRE PLUG TECH	
M5 85c			●	●	●	●			●											
M10 150c	●	●	●	●	●	●	●		●	●		●								
M13 164c	●	●	●	●	●	●	●	●	●	●	●	●						●		●
M17 168c	●	●	●	●	●	●	●		●	●		●	●			●	●			
M19 175c	●	●	●	●	●	●	●	●	●	●	●	●	●	●		●	●			
M20 203c	●	●	●	●	●	●	●	●	●	●	●	●	●		●	●	●	●		●
F10 116c	●	●	●	●	●	●	●		●	●		●								
F11 131c	●	●	●	●	●	●	●		●	●		●								●
F15 164c	●	●	●	●	●	●	●		●	●		●				●	●			
F16 179c	●	●	●	●	●	●	●		●	●		●				●	●			●

ARTICLE	UPC	NEW	MODEL	COLOR	WEIGHT	PRICE (€)
16753	641300167538		F16	Black	179g	60
16752	641300167521		F11	Black	131g	50
16092	641300160928		F15	Black/Silver	169g	50
16091	641300160911		F10+	Black/Silver	121g	40
16570	641300165701		Tool Cigar	Black/Silver	55g	30
17024	641300170248	new	Tool Slider Tire Lever Kit	Black	57g	10
16637	641300166371		Tire Plug Refill Kit (10 pieces)	-	-	5



PUMPS & CO₂

THE WORKSHOP ESSENTIAL



FLOOR PUMPS

POMPA A TERRA | POMPES A PIEDS



SERBATOIO REMOVIBILE

Installa e gonfia coperture tubeless con facilità.

RÉSERVOIR AMOVIBLE

Montage et gonflage des pneus tubeless aisé.



TUBO NASCOSTO

Viene riposta ordinatamente quando non utilizzata.

TUYAU FLEXIBLE INTÉGRÉ

Rangement pratique des éléments dans le corps de la pompe, après utilisation.



CONNESSIONE MAGNETICA VELOCE

Interfaccia facile per il beccuccio e per il serbatoio.

CONNECTION MAGNÉTIQUE ULTRA RAPIDE

Interface tuyau flexible/réservoir facile.



KLIC



STERLING



SAPPHIRE

ARTICLE	UPC	MODEL	COLOR	PSI / BAR	HEAD	BASE	PRICE (€)
16198*	641300161987	Klic W/ Analog Gauge + Canister	Silver	160 psi / 11 bar	Universal Presta / Schrader	-	220
16168	641300161680	Sterling	Silver	160 psi / 11 bar	Universal Presta / Schrader	Alloy	80
16303	641300163035	Sapphire	Black	160 psi / 11 bar	Universal Presta / Schrader	Steel	60

(*) Fino ad esaurimento scorte | Jusqu'à épuisement des stocks

HAND PUMPS

POMPE A MANO KLIC | POMPE A MAIN KLIC



PRESTA / SCHRADER READY

Svita e inverti la testa per passare da Presta a Schrader.

PRESTA / SCHRADER READY

Dévisser la tête pour basculer entre Presta et Schrader.



MANOMETRO

Preciso e facile da leggere.

MANOMÈTRES

Jauge très précise et facile à lire.

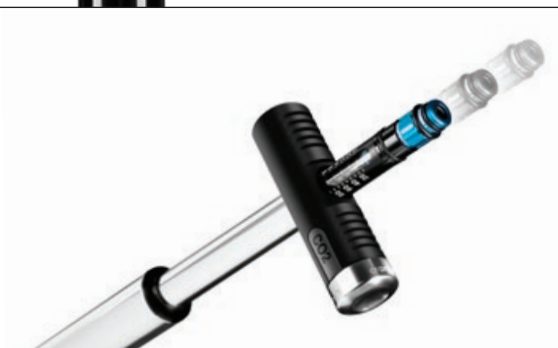

TESTA MAGNETICA ORIENTABILE

Testa magnetica orientabile a 360 gradi per evitare allo sporco di penetrare. Manichetta magnetica per installare la testa velocemente.

TÊTE MAGNETIQUE ORIENTABLE

Tête magnétique orientable à 360° évitant la pénétration de saletés. Extrémité du raccord magnétique permettant un montage rapide et facile sur la tête.

MANICHETTA FLESSIBILE/MANIGLIA BLOCCABILE /ADATTATORE CO2

La maniglia pieghevole permette di estrarre la manichetta. La testa magnetica con collarino orientabile per evitare allo sporco di penetrare. Adattatore CO2 integrato in alcuni modelli.

RACCORD FLESSIBILE ET ADAPTATEUR CO2 INCORPORE DANS LA POIGNE

Déverrouillage de la poignée pliable pour extraire le raccord. Tête magnétique orientable évitant la pénétration de saletés. Adaptateur CO2 intégré sur certains modèles.

KLIC HP

ROAD SPECIFIC HIGH PRESSURE: 120 PSI / 8.3 BAR



KLIC HV

MTB SPECIFIC HIGH VOLUME: 110 PSI / 7.6 BAR





HAND PUMPS

POMPE A MANO GEM | POMPE A MAIN GEM

130+ PSI / 9+ BAR

- Pompa premium, con adattatore alta pressione/alto volume brevettato per un gonfiaggio facilitato.
- Testa intelligente che si adatta automaticamente alla valvola presta o schrader.
- Disponibile in due lunghezze, con o senza manometro.
- Pompes premium avec interrupteur haute pression/haut volume breveté, pour un gonflage facile.
- Embout compatible pour adaptation sur valve Presta ou Schrader.
- Disponible en deux longueurs, avec ou sans manomètre.



CO2

CO2 CARTRIDGE



HAND PUMPS							
ARTICLE	UPC	MODEL	DESCRIPTION	COLOR	LENGTH	WEIGHT	PRICE (€)
16116*	641300161161	Klic HP	Klic HP Gauge W/ CO2	Silver	260mm	142g	60
16112*	641300161123		Klic HP		260mm	102g	40
16117*	641300161178	Klic HV	Klic HV Gauge W/ CO2	Silver	260mm	145g	60
16115*	641300161154		Klic HV Gauge		260mm	135g	50
16113*	641300161130		Klic HV		260mm	105g	40
14683	641300146830	Gem S	-	Red	176mm	131g	25
14685	641300146854		-	Green			25
14681	641300146816		-	Silver			25
CO2 CARTRIDGE							
ARTICLE	UPC	MODEL	WEIGHT	DESCRIPTION	PRICE (€)		
16235	641300162359	CO2 Cartridge	CO2 25g Cartridge	20 Units Bulk Pack	121		
16232	641300162328		CO2 25g Cartridge	(2 Units) W/ Inflator	20		
16230	64130016230		CO2 16g Cartridge	(2 Units) W/ Inflator	16		

(*) Fino ad esaurimento scorte | Jusqu'à épuisement des stocks

Continental 
The Future in Motion

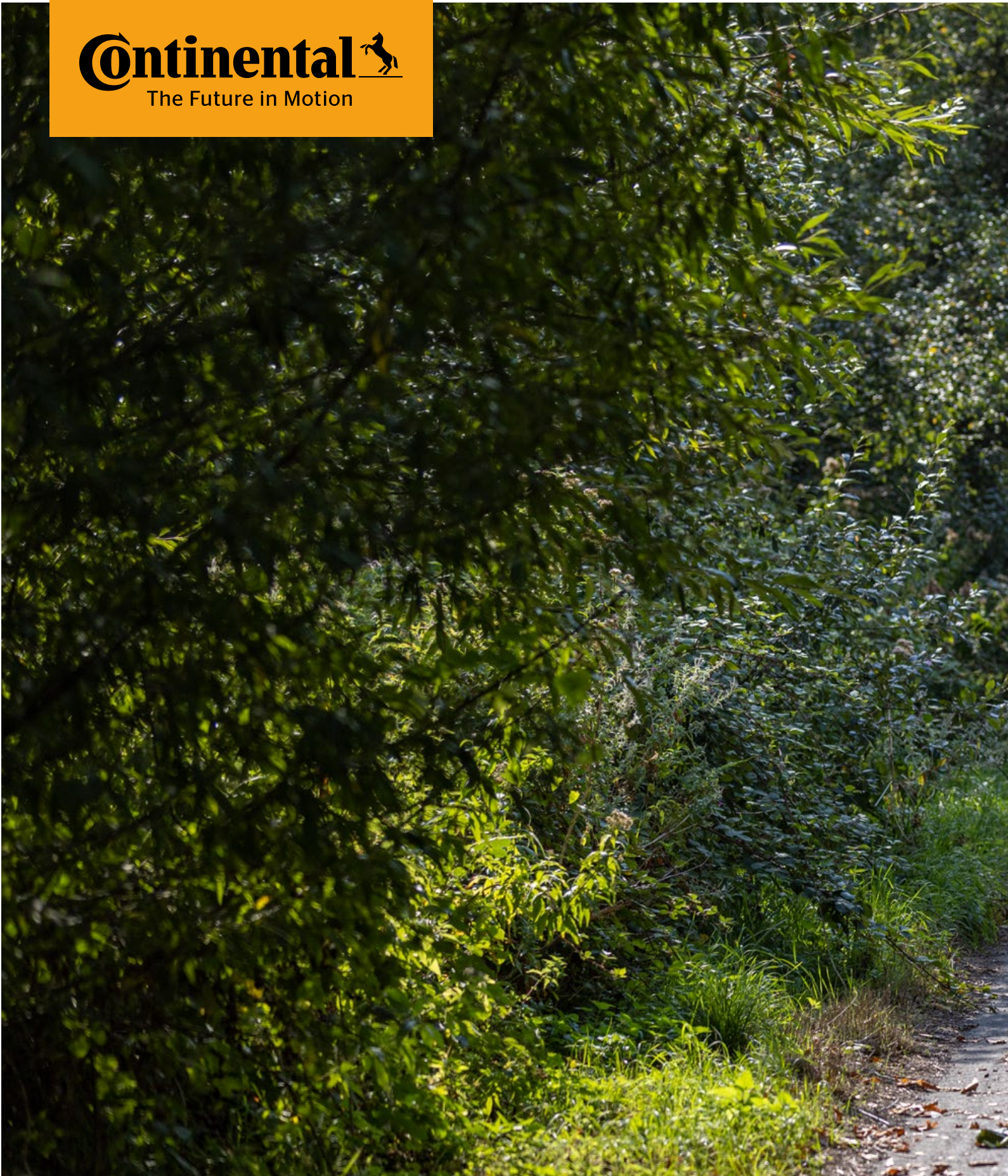



CONTINENTAL





ROAD & TUBULAR



PER IL CHILOMETRO IN PIÙ

Il più resistente Grand Prix 5000: dà fiducia in tutte le condizioni meteorologiche e aumenta la tua sicurezza.

POUR L'EXTRA MILE

Le plus puissant Grand Prix 5000 : crée la confiance par tous les temps et renforce votre protection.



ARTICLE	EAN	ETRTO	DIMENSION	COLOR/SIDEWALL	TECHNOLOGY	WEIGHT	BAR	MAX.BAR	PRICE (€)
C0101910	4019238056754	25-622	28" 700x25 C	black/black reflex skin fold.	Vectran B./LazerGrip	250g	5,0	7,5	104,99
C0101911	4019238056815	28-622	28" 700x28 C	black/black reflex skin fold.	Vectran B./LazerGrip	280g	5,2	6,5	104,99
C0101912	4019238056914	32-622	28" 700x32 C	black/black reflex skin fold.	Vectran B./LazerGrip	325g	3,5	5,0	104,99
C0101913	4019238056990	35-622	28" 700x35 C	black/black reflex skin fold.	Vectran B./LazerGrip	325g	2,5	4,5	104,99
C0101901	4019238056716	25-622	28" 700x25 C	black/cream reflex skin fold.	Vectran B./LazerGrip	250g	5,1	7,5	99,99
C0101902	4019238056792	28-622	28" 700x28 C	black/cream reflex skin fold.	Vectran B./LazerGrip	280g	5,3	6,5	99,99
C0101903	4019238056884	32-622	28" 700x32 C	black/cream reflex skin fold.	Vectran B./LazerGrip	315g	3,5	5,1	99,99
C0101904	4019238056952	35-622	28" 700x35 C	black/cream reflex skin fold.	Vectran B./LazerGrip	315g	2,5	4,5	99,99



VERSIONE TUBELESS

Il nuovo Grand Prix 5000 S Tubeless Ready: più leggero, più veloce e con fianchi più resistenti. Il nuovo standard della tecnologia tubeless ready su strada. Più velocità, più comfort e una maggiore protezione dalle forature per le tue uscite in bici. Fatto per migliorare le tue prestazioni.

VERSION TUBELESS

Le nouveau Grand Prix 5000 S Tubeless Ready : Plus léger, plus rapide et avec des flancs plus résistants. La nouvelle norme en matière de technologie Tubeless Ready pour la route. Roulez plus vite, plus confortablement et avec une protection accrue contre les crevaisons. Conçu pour vous rendre meilleur.



ARTICLE	EAN	ETRTO	DIMENSION	COLOR/SIDEWALL	TECHNOLOGY	WEIGHT	BAR	MAX.BAR	PRICE (€)
C0101866	4019238054439	25-622	28" 700x25C	black/black skin fold.	Vectran B./LazerGrip/ACT	245g	5,0	7,5	87,99
C0101873	4019238055559	25-622	28" 700x25C	black/transparent fold.	Vectran B./LazerGrip/ACT	295g	5,0	7,5	87,99
C0101867	4019238054422	28-622	28" 700x28C	black/black skin fold.	Vectran B./LazerGrip/ACT	270g	5,0	6,5	87,99
C0101874	4019238055580	28-622	28" 700x28C	black/transparent fold.	Vectran B./LazerGrip/ACT	315g	5,0	6,5	87,99
C0101868	4019238 054415	30-622	28" 700x30C	black/black fold.	Vectran B./LazerGrip/ACT	300g	4,0	5,0	87,99
C0101869	4019238054408	32-622	28" 700x32C	black/black skin fold.	Vectran B./LazerGrip/ACT	320g	3,5	5,0	87,99
C0101876	4019238055641	32-622	28" 700x32C	black/transparent fold.	Vectran B./LazerGrip/ACT	375g	3,5	5,0	87,99



È IL TUO MOMENTO

La nuova era nel ciclismo: il miglior allrounder del settore, portato ad un livello di prestazioni completamente nuovo.

C'EST VOTRE TEMPS

La nouvelle ère du cyclisme - Le meilleur acteur sur le terrain, permet d'atteindre le plus haut niveau de performance.



ARTICLE	EAN	ETRTO	DIMENSION	COLOR/SIDEWALL	TECHNOLOGY	WEIGHT	BAR	MAX.BAR	PRICE (€)
Grand Prix 5000									
C0101624	4019238007824	25-622	28" 700x25 C	black/black skin foldable	Vectran B./LazerGrip/ACT	215g	6,50	8,50	74,99
C0101895	4019238056235	25-622	28" 700x25 C	black/transparent fold.	Vectran B./LazerGrip/ACT	225g	6,50	8,50	74,99
C0101947	4019238 064711	25- 622	28" 700x25C	black/cream foldable	Vectran B./LazerGrip/ACT	260g	6,50	8,50	74,99
C0101625	4019238007848	28-622	28" 700x28 C	black/black skin foldable	Vectran B./LazerGrip/ACT	235g	6,50	8,00	74,99
C0101896	4019238056242	28-622	28" 700x28 C	black/transparent fold.	Vectran B./LazerGrip/ACT	235g	6,50	8,50	74,99
C0101948	4019238 064728	28-622	28" 700x28C	black/cream foldable	Vectran B./LazerGrip/ACT	290g	6,50	8,00	74,99
C0101813	4019238041972	30-622	28" 700x30 C	black/black skin foldable	Vectran B./LazerGrip/ACT	260g	6,00	7,00	74,99
C0101626	4019238007855	32-622	28" 700x32 C	black/black skin foldable	Vectran B./LazerGrip/ACT	290g	6,00	7,00	74,99



PRONTO PER OGNI STAGIONE

L'elevata protezione dalle forature e la lunga durata caratterizzano il Grand Prix 4-Season. Oltre che per durevolezza questo pneumatico si impone per un'ottima aderenza. Che si trovi in una competizione piuttosto che in un tour, chi lo usa beneficia della grande resistenza del tessuto DuraSkin della carcassa, un compagno affidabile per il ciclista assiduo.

ÉQUIPÉ POUR TOUTES LES SAISONS

Le Grand Prix 4-Season étonne par sa résistance aux contraintes extrêmes et ses performances kilométriques élevées. Il offre également une excellente adhérence sur le mouillé et en conditions hivernales à basse température. Sa double protection Vectran™ et son renfort de carcasse DuraSkin® vous met à l'abri des crevaisons et coupures. Un pneu excellent pour les grandes randos comme pour la compétition et pas uniquement en hiver!



ARTICLE	EAN	ETRTO	DIMENSION	COLOR/SIDEWALL	TECHNOLOGY	WEIGHT	BAR	MAX.BAR	PRICE (€)
Grand Prix 4-Season									
C0100175	4019238409116	25-622	700x25 C	black DuraSkin fold.	Double Vectran Breaker	230g	6,5	8,5	74,99
C0101105	4019238674620	28-622	700x28 C	black DuraSkin fold.	Double Vectran Breaker	295g	6,5	8,0	74,99
C0101095	4019238668131	32-622	700x32 C	black DuraSkin fold.	Double Vectran Breaker	340g	6,0	7,0	74,99



ALL-ROUNDER CONFORTEVOLE

Grand Prix è un classico all-rounder con un battistrada dal design moderno. È destinato alle biciclette da passeggio e da città. Offre una combinazione perfetta tra protezione dalle forature, comfort e scorrevolezza. Caratterizzato da una durata molto elevata, rende ogni tour un piacere puro. Uno strumento polivalente, con tante qualità.

POLYVALENCE ET CONFORT

Le Grand Prix est un classique synonyme de qualité et de performance. Il apporte une symbiose incontestable entre protection anti-crevaisson, résistance à l'usure, performance et adhérence. Le profil moderne et le témoin d'usure complètent ses atouts. Un pneu très qualitatif qui apporte beaucoup de plaisir en randonnée.



ARTICLE	EAN	ETRTO	DIMENSION	COLOR/SIDEWALL	TECHNOLOGY	WEIGHT	BAR	MAX.BAR	PRICE (€)
Grand Prix									
C0100506	4019238564617	23-622	700x23 C	black foldable	PolyX Breaker	225g	7,5	8,5	49,99
C0100637	4019238581409	25-622	700x25 C	black foldable	PolyX Breaker	230g	7,5	8,5	49,99
C0101109	4019238674590	28-622	700x28 C	black foldable	PolyX Breaker	275g	6,5	8,0	49,99



ALL-ROUNDER NEL SEGMENTO PERFORMANCE

Lo pneumatico Grand Sport Race ti porta al massimo rendimento. La combinazione perfetta di elevata protezione dalle forature, alto comfort e scorrevolezza lo rendono ideale per le competizioni e i tour. Ulteriori punti a favore sono il massimo grip in curva e la lunga durata. È un all-rounder pronto per qualsiasi sfida, anche la più impegnativa.

LE MODÈLE POLYVALENT DU SEGMENT PERFORMANCE

Le Grand Sport Race pousse à la performance. C'est un pneu complet et équilibré avec une protection anticrevaillon et suffisamment de PureGrip Compound sur la surface de roulement qui lui permettent d'avaler sans effort les nombreux kilomètres de courses et d'entraînement. Il offre une adhérence maximale en courbes et un roulement confortable: ce multi-talents est prêt à relever tous les défis, quels qu'ils soient.



ARTICLE	EAN	ETRTO	DIMENSION	COLOR/SIDEWALL	TECHNOLOGY	WEIGHT	BAR	MAX.BAR	PRICE (€)
Grand Sport Race									
C0150001	4019238586565	23-622	700x23 C	black foldable	NyTech Breaker	230g	7,5	8,5	39,99
C0150027	4019238587319	25-622	700x25 C	black foldable	NyTech Breaker	270g	6,5	8,5	39,99
C0150118	4019238621105	28-622	700x28 C	black foldable	NyTech Breaker	330g	5,5	8,0	39,99



PNEUMATICI MODERNI PER CHI SI AVVICINA ALLE GARE IN BICICLETTA

Gomme adatte per il ciclismo in genere e per le competizioni. Un assortimento completo per allestire al meglio la tua bici con un eccellente rapporto qualità/prezzo. Disponibili in molte sezioni e colorazioni.

NOUVELLE GÉNÉRATION DE PNEU POUR QUI DÉCOUVRE LE VÉLO

Pneus pour toutes pratiques route et compétitions. Assortiment complet pour améliorer votre vélo avec un rapport qualité-prix exceptionnel. Disponible dans de nombreuses tailles et couleurs.



ARTICLE	EAN	ETRTO	DIMENSION	COLOR/SIDEWALL	TECHNOLOGY	WEIGHT	BAR	MAX.BAR	PRICE (€)
Ultra Sport III									
C0150449	4019238026641	23-622	700x23 C	black skin foldable	Performance	320g	7,5	8,5	29,99
C0150457	4019238026849	25-622	700x25 C	black skin foldable	Performance	270g	6,5	8,5	29,99
C0150466	4019238026917	28-622	700x28 C	black skin foldable	Performance	420g	5,5	8,0	29,99





ALL-ROUNDER NELLA CORSA PROFESSIONISTICA

Competition è un all-rounder di utilizzo professionale all'altezza del livello World Tour. È un versatile tuttofare, veloce ed agile, che emerge al termine delle maggiori competizioni al mondo grazie al carattere sempre combattivo. Spicca per la valida miscela sviluppata specificamente da Continental e per l'inserito di protezione dalle forature.

LE MODÈLE POLYVALENT DU MONDE DES PROS

Le Competition est un multi-talents qui répond à toute les exigences des ProTour et autres compétitions. Ce boyau s'adapte à toutes les conditions de route et apporte agilité et vitesse. Il fait preuve d'un caractère des plus combatifs. Le mélange de gomme performant développé par Continental combiné à une protection anti-crevaison ultra efficace lui fait prendre le rôle d'un avant-gardiste.



ARTICLE	EAN	ETRTO	DIMENSION	COLOR/SIDEWALL	TECHNOLOGY	WEIGHT	BAR	MAX.BAR	PRICE (€)
Competition									
C0196189	4019238549126	-	28"x25 mm	black	Vectran Breaker	280g	8,0	12,0	130,99



UN CLASSICO PER LE GRANDI CLASSICHE

A suo agio sulle strade del Giro delle Fiandre, della Parigi-Roubaix o della Milano-Sanremo. È uno pneumatico che si caratterizza per durata, per resistenza anche su fondi dissestati e per l'elevata protezione dalle forature. Incamera grandi quantità d'aria, ad ulteriore garanzia di sicurezza, scorrevolezza e comfort, anche negli attraversamenti veloci sul pavé.

LE CHASSEUR CLASSIQUE PASSIONNÉ

Le Sprinter Gatorskin est chez lui sur les routes de Flandre, de Roubaix ou de San Remo. Ce boyau développé spécialement pour les courses classiques sait convaincre par sa grande résistance aux crevaisons et sa longévité kilométrique. Son volume important assure une sécurité supplémentaire et un roulement encore meilleur. Tout cela offre un grand confort sur la route même à pleine vitesse sur les pavés.



ARTICLE	EAN	ETRTO	DIMENSION	COLOR/SIDEWALL	TECHNOLOGY	WEIGHT	BAR	MAX.BAR	PRICE (€)
Sprinter Gatorskin									
C0196187	4019238549089	-	28"x25 mm	black	SafetySystem Breaker	300g	8,0	12,0	84,99



A CACCIA DI VITTORIE

Lo Sprinter è caratterizzato da eccezionali proprietà di rotolamento grazie alla carcassa morbida. Offre il massimo nelle gare a circuito o nel triathlon. È la risposta giusta per chi chiede massima accelerazione e a questo aggiunge un peso ridotto e una manovrabilità equilibrata, grazie al suo profilo perfettamente slick.

LA CHASSE AUX POINTS

Le Sprinter se distingue par ses excellentes propriétés de roulement grâce à sa carcasse souple. Il joue ses atouts surtout dans le domaine des critériums. On peut se fier à ce boyau quand il est question d'accélération maximale. Ce boyau de compétition se distingue par son faible poids et sa conduite équilibrée.



ARTICLE	EAN	ETRTO	DIMENSION	COLOR/SIDEWALL	TECHNOLOGY	WEIGHT	BAR	MAX.BAR	PRICE (€)
Sprinter									
C0196244	4019238674576	-	28"x25 mm	black	SafetySystem Breaker	295g	8,0	12,0	66,99



COMPAGNO DI ALLENAMENTO PER PRINCIPIANTI

Il tubolare Giro spicca per la durata elevata e per l'eccellente rapporto prezzo/prestazione/durata. Ottime le sue proprietà di rotolamento e per la robustezza garantita anche dopo molti chilometri di allenamento. Questo pneumatico è il compagno perfetto nell'allenamento e nei tour di chi vuole avvicinarsi in modo serio al ciclismo.

LE PARTENAIRE D'ENTRAÎNEMENT POUR LES DÉBUTANTS

Le Giro fait sensation grâce à sa grande capacité de kilométrage et son excellent rapport qualité-prix. Il se distingue par ses excellentes propriétés de roulage et sa robustesse et il est toujours prêt même après de nombreux kilomètres d'entraînement. Ce boyau est le compagnon idéal pour les débutants, pour l'entraînement et en randonnées.

ARTICLE	EAN	ETRTO	DIMENSION	COLOR/SIDEWALL	TECHNOLOGY	WEIGHT	BAR	MAX.BAR	PRICE (€)
Giro									
C0196017	4019238107715	-	28"x22 mm	black/transparent	Performance	390g	8,0	10,0	39,99



GRAVEL



SCEGLI UNA STRADA DIVERSA, SCEGLI TERRA

Per la tua traccia fuori strada. Per più comfort. Per l'avventura. Che sia un giro lungo, o la scorciatoia per la strada di casa. La nuova serie gravel Terra di Continental ti porta proprio dove vuoi arrivare. Terra Speed è il modello più veloce della nostra gamma. Fatto per accompagnarti tra l'asfalto e la sabbia. Fatto per accompagnarti tra percorsi sconnessi o veloci. Scegli una strada diversa, scegli Terra.

CHOISISSEZ UNE AUTRE ROUTE, CHOISISSEZ TERRA

Pour vos parcours en dehors de la route. Pour plus de confort. Pour l'aventure. Que ce soit un long trajet, ou le raccourci vers la maison. Le nouveau pneu Gravel Terra de Continental vous emmène là où vous souhaitez aller. Terra Speed est le modèle le plus rapide de notre gamme. Fait pour vous accompagner entre l'asphalte et le sable. Fait pour vous accompagner sur les itinéraires accidentés ou rapides. Choisissez un autre chemin, choisissez Terra.



ARTICLE	EAN	ETRTO	DIMENSION	COLOR/SIDEWALL	TECHNOLOGY	WEIGHT	BAR	MAX.BAR	PRICE (€)
Terra Speed									
C0101720	4019238029772	35-584	650x35 B 27.5x1.35	black/cream skin fold.	ProTaction	350g	3,0	5,0	69,99
C0101718	4019238029611	40-584	650x40 B 27.5x1.50	black/cream skin fold.	ProTaction	420g	3,0	5,0	69,99
C0101700	4019238026955	35-622	700x35 C 28x1.35	black/cream skin fold.	ProTaction	360g	3,0	5,0	69,99
C0101702	4019238027020	40-622	700x40 C 28x1.50	black/cream skin fold.	ProTaction	440g	3,0	5,0	69,99
C0101837	4019238052053	40-622	700x40 C 28x1.50	black/transp. skin fold.	ProTaction	440g	3,0	5,0	69,99
C0102007	4019238083439	45-622	700x45 C 28x1.70	black/transp. skin fold.	ProTaction	490g	3,0	5,0	69,99
C0101719	4019238029796	35-584	650x35 B 27.5x1.35	black/black foldable	ProTaction	390g	3,0	5,0	69,99
C0101693	4019238027013	35-622	700x35 C 28x1.35	black/black foldable	ProTaction	410g	3,0	5,0	69,99
C0101717	4019238029635	40-584	650x40 B 27.5x1.50	black/black foldable	ProTaction	420g	3,0	5,0	69,99
C0101694	4019238027099	40-622	700x40 C 28x1.50	black/black foldable	ProTaction	440g	3,0	5,0	69,99



SCEGLI UNA STRADA DIVERSA, SCEGLI TERRA

Per la tua traccia fuori strada. Per più comfort. Per l'avventura. Che sia un giro lungo, o la scorciatoia per la strada di casa. La nuova serie gravel Terra di Continental ti porta proprio dove vuoi arrivare. Il modello Terra Trail è il più nobile della nostra gamma. Fatto per accompagnarti tra percorsi sconnessi o veloci. Scegli una strada diversa, scegli Terra.

CHOISISSEZ UNE AUTRE ROUTE, CHOISISSEZ TERRA

Pour vos parcours en dehors de la route. Pour plus de confort. Pour l'aventure. Que ce soit un long trajet, ou le raccourci vers la maison. Le nouveau pneu Gravel Terra de Continental vous emmène là où vous souhaitez aller. Le modèle Terra Trail est le plus noble de notre gamme. Fait pour vous accompagner sur les itinéraires accidentés ou rapides. Choisissez un autre chemin, choisissez Terra.



ARTICLE	EAN	ETRTO	DIMENSION	COLOR/SIDEWALL	TECHNOLOGY	WEIGHT	BAR	MAX.BAR	PRICE (€)
Terra Trail									
C0101716	4019238029659	40-584	650x40 B 27.5x1.50	black/cream skin fold.	ProTecton	440g	3,0	5,0	69,99
C0101701	4019238027044	40-622	700x40 C 28x1.50	black/cream skin fold.	ProTecton	440g	3,0	5,0	69,99
C0101836	4019238052060	40-622	700x40 C 28x1.50	black/transp. skin fold.	ProTecton	440g	3,0	5,0	69,99
C0101715	4019238029673	40-584	650x40 B 27.5x1.50	black/black skin fold.	ProTecton	440g	3,0	5,0	69,99
C0101697	4019238027075	40-622	700x40 C 28x1.50	black/black skin fold.	ProTecton	460g	3,0	5,0	69,99
C0150509	4019238038507	47-584	650x47 B 27.5x1.75	black/black skin fold.	ShieldWall Syst.	520g	2,5	4,5	39,99
C0150508	4019238038538	47-584	650x47 B 27.5x1.75	black/cream skin fold.	ShieldWall Syst.	510g	2,5	4,5	39,99
C0150503	4019238038460	35-622	700x35 C 28x1.35	black/black skin fold.	ShieldWall Syst.	425g	3,0	5,0	39,99
C0150505	4019238038491	35-622	700x35 C 28x1.35	black/cream skin fold.	ShieldWall Syst.	445g	3,0	5,0	39,99
C0150507	4019238038545	40-622	700x40 C 28x1.50	black/black skin fold.	ShieldWall Syst.	495g	3,0	5,0	39,99
C0150673	4019238064506	40-622	700x40 C 28x1.50	black/brown skin fold.	ShieldWall Syst.	440g	3,0	5,0	39,99
C0150675	4019238064476	45-622	700x45 C 28x1.70	black/black skin fold.	ShieldWall Syst.	500g	2,5	4,5	39,99



MTB

KRYPTOTAL^{Fr}Umido
Terrain Mixte

LA SCELTA PER TERRENI E CONDIZIONI MISTI

Progettato per abbinarsi perfettamente al Kryptotal Re e ottimizzato per manovrabilità e agilità della ruota anteriore. Ideale per terreni misti e per l'impiego Trail, Enduro o DH Gravity.

CONÇU POUR LES TERRAINS ET CONDITIONS MIXTES

Conçu pour fonctionner avec le Kryptotal Re et optimiser la maniabilité et l'agilité de la roue avant. Idéal sur les terrains mixtes en trail, enduro et descente.



ARTICLE	EAN	ETRTO	DIMENSION	COLOR/SIDEWALL	TECHNOLOGY	WEIGHT	BAR	MAX.BARPRICE (€)
Kryptotal-FR 2.4								
C0101957	4019238070491	60-622	29" 29x2.40	black/black fold. skin	Downhill/Super Soft Comp.	1290g	2,5 3,5	99,00
C0150694	4019238074116	60-584	27.5" 27.5x2.40	black/black fold. skin	Enduro/Soft Comp.	1080g	2,5 3,5	85,00
C0150696	4019238074079	60-622	29" 29x2.40	black/black fold. skin	Enduro/Soft Comp.	1125g	2,5 3,5	85,00
C0150695	4019238074093	60-584	27.5" 27.5x2.40	black/black fold. skin	Trail/Endurance Comp.	1000g	2,5 3,5	73,00
C0150697	4019238074055	60-622	29" 29x2.40	black/black fold. skin	Trail/Endurance Comp.	1040g	2,5 3,5	73,00

KRYPTOTAL^{Re}Umido
Terrain Mixte

LA SCELTA PER TERRENI E CONDIZIONI MISTI

Ottimizzato per la ruota posteriore, questo pneumatico offre massima versatilità ed equilibrio tra aderenza, trazione in frenata e resistenza al rotolamento. Nato per eccellere sui terreni misti, è la scelta ideale per raidare al limite nella tua disciplina preferita: Trail, Enduro o DH Gravity.

CONÇU POUR LES TERRAINS ET CONDITIONS MIXTES

Conçu pour la roue arrière, ce pneu polyvalent est le parfait équilibre entre stabilité, motricité et résistance au roulement. Idéal pour repousser vos limites en trail, enduro ou en descente.



ARTICLE	EAN	ETRTO	DIMENSION	COLOR/SIDEWALL	TECHNOLOGY	WEIGHT	BAR	MAX.BARPRICE (€)
Kryptotal-RE 2.4								
C0101991	4019238080780	60-584	27.5" 27.5x2.40	black/black fold. skin	Downhill/Soft Comp.	1220g	2,5 3,5	95,00
C0101992	4019238080773	60-622	29" 29x2.40	black/black fold. skin	Downhill/Soft Comp.	1290g	2,5 3,5	95,00
C0101993	4019238080766	60-584	27.5" 27.5x2.40	black/black fold. skin	Enduro/Soft Comp.	1080g	2,5 3,5	85,00
C0150634	4019238063127	60-622	29" 29x2.40	black/black fold. skin	Enduro/Soft Comp.	1125g	2,5 3,5	85,00
C0150637	4019238063059	60-584	27.5" 27.5x2.40	black/black fold. skin	Trail/Endurance Comp.	1000g	2,5 3,5	73,00
C0150638	4019238063042	60-622	29" 29x2.40	black/black fold. skin	Trail/Endurance Comp.	1040g	2,5 3,5	73,00
Kryptotal-RE 2.6								
C0150635	4019238063097	65-584	27.5" 27.5x2.60	black/black fold. skin	Enduro/Soft Comp.	1220g	2,0 3,0	89,00
C0150636	4019238063080	65-622	29" 29x2.60	black/black fold. skin	Enduro/Soft Comp.	1275g	2,0 3,0	89,00
C0150639	4019238063011	65-584	27.5" 27.5x2.60	black/black fold. skin	Trail/Endurance Comp.	1100g	2,0 3,0	81,00
C0150640	4019238063004	65-622	29" 29x2.60	black/black fold. skin	Trail/Endurance Comp.	1200g	2,0 3,0	81,00



ARGOTAL

Bagnato
Terrain Meuble

LA SCELTA PER TERRENI MORBIDI

Ideale per terreni smossi, questo pneumatico offre massima stabilità in curva e maggiore aderenza laterale. Il disegno aperto del battistrada aumenta la capacità autopulente, l'ideale per spingere al massimo tra sterrati e polvere.

CONÇU POUR LES TERRAINS MEUBLES

Pneu idéal pour les terrains meubles, avec une adhérence latérale accrue pour une bonne stabilité dans les virages. La bande de roulement ouverte permet un auto-nettoyage afin que vous puissiez repousser vos limites de conduite sur terrains la poussiéreux et meubles.



ARTICLE	EAN	ETRTO	DIMENSION	COLOR/SIDEWALL	TECHNOLOGY	WEIGHT	BAR	MAX.BAR	PRICE (€)
Argotal 2.4									
C0150684	4019238068016	60-584	27.5" 27.5x2.40	black/black fold. skin	Enduro/Soft Comp.	1080g	2,5	3,5	85,00
C0150686	4019238068078	60-622	29" 29x2.40	black/black fold. skin	Enduro/Soft Comp.	1160g	2,5	3,5	85,00
C0150689	4019238067972	60-584	27.5" 27.5x2.40	black/black fold. skin	Trail/Endurance Comp.	1000g	2,5	3,5	73,00
C0150691	4019238068030	60-622	29" 29x2.40	black/black fold. skin	Trail/Endurance Comp.	1040g	2,5	3,5	73,00
Argotal 2.6									
C0150685	4019238067910	65-584	27.5" 27.5x2.60	black/black fold. skin	Enduro/Soft Comp.	1220g	2,0	3,0	89,00
C0150688	4019238067958	65-622	29" 29x2.60	black/black fold. skin	Enduro/Soft Comp.	1275g	2,0	3,0	89,00
C0150690	4019238067897	65-584	27.5" 27.5x2.60	black/black fold. skin	Trail/Endurance Comp.	1100g	2,0	3,0	81,00
C0150692	4019238067934	65-622	29" 29x2.60	black/black fold. skin	Trail/Endurance Comp.	1200g	2,0	3,0	81,00



Asciutto
Terrain Dur



LA SCELTA PER TERRENI COMPATTI E CONDIZIONI DI ASCIUTTO

Perfetto per superfici dure e rocciose. Bassa resistenza al rotolamento e bordi di contatto studiati per migliorare la trazione e la frenata. Ideale per le uscite gravity veloci, quando serve maggiore grip e maggiore sicurezza.

CONÇU POUR LES TERRAINS DURS ET LES CONDITIONS SÈCHES

Parfait pour les surfaces dures et rocailleuses. Profiter d'un roulage rapide et d'un freinage puissant en toute confiance grâce à une adhérence continue lorsque vous en avez le plus besoin.



ARTICLE	EAN	ETRTO	DIMENSION	COLOR/SIDEWALL	TECHNOLOGY	WEIGHT	BAR	MAX.BAR	PRICE (€)
Xynotal 2.4									
C0150646	4019238063257	60-584	27.5" 27.5x2.40	black/black fold. skin	Trail/Endurance Comp.	1000g	2,5	3,5	73,00
C0150647	4019238063240	60-622	29" 29x2.40	black/black fold. skin	Trail/Endurance Comp.	1040g	2,5	3,5	73,00

4 NAMES, 5 PATTERNS,

The all Gravity

CAS

TERRAIN

	TRAIL				ENDURO	
HARD PACK	27.5" X 2.4 XY XYNOTAL	29" X 2.4 XY XYNOTAL			27.5" X 2.4 XY XYNOTAL	29" X 2.4 XY XYNOTAL
MIXED	27.5" X 2.4 ^{Fr} KR KRYPTOTAL	29" X 2.4 ^{Fr} KR KRYPTOTAL			27.5" X 2.4 ^{Fr} KR KRYPTOTAL	29" X 2.4 ^{Fr} KR KRYPTOTAL
LOOSE	27.5" X 2.4 ^{Re} KR KRYPTOTAL	27.5" X 2.6 ^{Re} KR KRYPTOTAL	29" X 2.4 ^{Re} KR KRYPTOTAL	29" X 2.6 ^{Re} KR KRYPTOTAL	27.5" X 2.4 ^{Re} KR KRYPTOTAL	27.5" X 2.6 ^{Re} KR KRYPTOTAL
MUD	27.5" X 2.4 AR ARGOTAL	27.5" X 2.6 AR ARGOTAL	29" X 2.4 AR ARGOTAL	29" X 2.6 AR ARGOTAL	27.5" X 2.4 AR ARGOTAL	27.5" X 2.6 AR ARGOTAL

TERRAIN













COMPOUND



INFINITE POSSIBILITIES

ty Range

ING

		DOWNHILL SOFT 		DOWNHILL SUPER SOFT 	
		27.5" X 2.4	29" X 2.4	27.5" X 2.4	29" X 2.4
		XY XYNOTAL	XY XYNOTAL	XY XYNOTAL	XY XYNOTAL
				27.5" X 2.4 	29" X 2.4 
				KR KRYPTOTAL	KR KRYPTOTAL
29" X 2.4 	29" X 2.6 	27.5" X 2.4 	29" X 2.4 	27.5" X 2.4 	29" X 2.4 
KR KRYPTOTAL	KR KRYPTOTAL	KR KRYPTOTAL	KR KRYPTOTAL	KR KRYPTOTAL	KR KRYPTOTAL
29" X 2.4	29" X 2.6	27.5" X 2.4	29" X 2.4	27.5" X 2.4	29" X 2.4
AR ARGOTAL	AR ARGOTAL	AR ARGOTAL	AR ARGOTAL	AR ARGOTAL	AR ARGOTAL

RIDING



CASING







UN ALL-ROUNDER PRIMO DELLA CLASSE, COLLAUDATO ANCHE NELLE COMPETIZIONI

- pneumatico versatile per la gara e il trail, stabile in curva e comodo
- buona aderenza, declinato con varie tecnologie
- pneumatico scorrevole, il suo battistrada si adatta a qualsiasi terreno

UN MODÈLE POLYVALENT DE PREMIÈRE CLASSE QUI A ÉGALEMENT FAIT SES PREUVES EN COMPÉTITION

- pneu versatile, aussi à l'aise en compétition que sur piste, très adhérent dans les virages et confortable
- bonne adhérence, avec plusieurs technologies disponibles
- roulement souple qui s'adapte à tous types de terrain grâce à une bande de roulement spéciale



ARTICLE	EAN	ETRTO	DIMENSION	COLOR/SIDEWALL	TECHNOLOGY	WEIGHT	BAR	MAX.BAR	PRICE (€)
Cross-King 2.2 ProTecton									
C0101483	4019238798036	55-559	26x2.2	black skin foldable	ProTecton	590g	3,0	4,0	67,90
C0101465	4019238798050	55-584	27.5x2.2	black skin foldable	ProTecton	620g	3,0	4,0	67,90
C0101965	4019238071474	55-584	27.5x2.2	black/transp. fold.	ProTecton	630g	3,0	4,0	67,90
C0101471	4019238798043	55-622	29x2.2	black skin foldable	ProTecton	660g	3,0	4,0	67,90
C0101966	4019238071467	55-622	29x2.2	black/transp. fold.	ProTecton	670g	3,0	4,0	67,90
Cross King 2.2 ShieldWall									
C0150303	4019238797480	55-559	26x2.2	black skin foldable	ShieldWall System	700g	3,0	4,0	36,90
C0150291	4019238797503	55-584	27.5x2.2	black skin foldable	ShieldWall System	740g	3,0	4,0	36,90
C0150295	4019238797497	55-622	29x2.2	black skin foldable	ShieldWall System	790g	3,0	4,0	36,90
Cross King 2.3 ProTecton									
C0101463	4019238798364	58-584	27.5x2.3	black foldable	ProTecton	730g	2,8	3,8	67,90
C0101475	4019238798418	58-622	29x2.3	black foldable	ProTecton	770g	2,8	3,8	67,90
Cross King 2.3 ShieldWall									
C0150302	4019238798319	58-559	26x2.3	black foldable	ShieldWall System	730g	2,8	3,8	36,90
C0150290	4019238798296	58-584	27.5x2.3	black foldable	ShieldWall System	780g	2,8	3,8	36,90
C0150297	4019238798326	58-622	29x2.3	black foldable	ShieldWall System	830g	2,8	3,8	36,90
Cross King 2.6 ShieldWall									
C0150337	4019238003581	65-584	27.5x2.60	black skin foldable	ShieldWall System	920g	2,0	3,0	40,99
C0150502	4019238037258	65-622	29x2.60	black skin foldable	ShieldWall System	995g	2,0	3,0	40,99
Cross-King 2.6 ProTecton									
C0101384	4019238773606	65-584	27.5x2.6	black foldable	ProTecton	810g	2,0	3,0	89,99
Cross-King 2.8 ShieldWall									
C0150336	4019238003611	70-584	27.5x2.80	black skin foldable	ShieldWall System	1040g	1,8	2,8	40,99



SICURO A SPASSO TRA LA NATURA

Il Mountain King dà il meglio di sé sulle biciclette da all mountain. La scolpitura direzionale e antisdrucchiolevole lo rendono un ideale pneumatico anteriore, visto che i tasselli centrali mordono, mentre quelli laterali aderiscono ed offrono un buon grip su qualsiasi terreno. È il compagno perfetto per le uscite sportive.

TRAVERSER LES TERRAINS EN TOUTE SÉCURITÉ

Le Mountain King révèle ses qualités en All Mountain. Grâce à la géométrie ouverte et à bonne adhérence de son profil, c'est le pneu avant idéal. Le mordant de ses crampons médians et l'adhérence de ses crampons latéraux lui donne un très bon grip sur tous les terrains. Ce pneu est le compagnon idéal pour les virées sportives.



ARTICLE	EAN	ERTRO	DIMENSION	COLOR/SIDEWALL	TECHNOLOGY	WEIGHT	BAR	MAX.BAR	PRICE (€)
Mountain King 2.3 ProTaction									
C0101461	4019238798371	58-584	27.5x2.3	black skin foldable	ProTaction	730g	2,8	3,8	69,90
C0101469	4019238798432	58-622	29x2.3	black skin foldable	ProTaction	770g	2,8	3,8	69,90
Mountain King III 2.3 ShieldWall									
C0150301	4019238798333	58-559	26x2.3	black skin foldable	ShieldWall System	730g	2,8	3,8	36,99
C0150289	4019238798302	58-584	27.5x2.3	black skin foldable	ShieldWall System	770g	2,8	3,8	36,99
C0150294	4019238798340	58-622	29x2.3	black skin foldable	ShieldWall System	820g	2,8	3,8	36,99
Mountain King 2.6/2.8 ShieldWall									
C0150335	4019238003598	65-584	27.5x2.6	black skin foldable	ShieldWall System	935g	2,0	3,0	40,99
C0150334	4019238003628	70-584	27.5x2.8	black skin foldable	ShieldWall System	1020g	1,8	2,8	40,99
Mountain King 2.6 ProTaction									
C0101583	4019238003543	65-584	27.5x2.6	black foldable	ProTaction	810g	2,0	3,0	79,90



UN CLASSICO PER GLI AGONISTI

Il Race King è un classico tipo da competizione. È gettonatissimo nelle gare di cross-country o nelle marathons e si addice sia alle front che alle full suspended. Spicca per la bassa resistenza al rotolamento, ha una carcassa voluminosa e un'ottima capacità di smorzare i colpi. Il battistrada garantisce i requisiti più utili per il biker assiduo.

LE PREMIER CHOIX DES COUREURS

Le Race King est le type même du classique de compétition. Ce pneu est utilisé dans les courses de cross country ou les marathons et est également adapté aux hardtails et aux races fullys. Il sait convaincre par sa faible résistance au roulement, sa carcasse volumineuse et son excellent amortis. Son profil offre les meilleures conditions aux cyclistes assidus.



ARTICLE	EAN	ETRTO	DIMENSION	COLOR/SIDEWALL	TECHNOLOGY	WEIGHT	BAR	MAX.BAR	PRICE (€)
Race King 2.0 ShieldWall									
C0150309	4019238797527	50-584	27.5x2.0	black foldable	ShieldWall System	630g	3,5	4,5	36,90
C0150307	4019238797534	50-622	29x2.0	black foldable	ShieldWall System	660g	3,5	4,5	36,90
Race King 2.2 ProTaction									
C0101486	4019238798111	55-559	26x2.2	black skin foldable	ProTaction	560g	3,0	4,0	67,90
C0101467	4019238798135	55-584	27.5x2.2	black skin foldable	ProTaction	590g	3,0	4,0	67,90
C0101962	4019238071504	55-584	27.5x2.2	black/transp. fold.	ProTaction	590g	3,0	4,0	67,90
C0101473	4019238798128	55-622	29x2.2	black skin foldable	ProTaction	620g	3,0	4,0	67,90
C0101963	4019238071498	55-622	29x2.2	black/transp. fold.	ProTaction	630g	3,0	4,0	67,90
Race King 2.2 ShieldWall									
C0150304	4019238797541	55-559	26x2.2	black skin foldable	ShieldWall System	660g	3,0	4,0	36,99
C0150292	4019238797565	55-584	27.5x2.2	black skin foldable	ShieldWall System	700g	3,0	4,0	36,99
C0150296	4019238797558	55-622	29x2.2	black skin foldable	ShieldWall System	740g	3,0	4,0	36,99





URBAN



LA COMBINAZIONE ULTIMA

Un pneumatico polivalente su qualsiasi tipo di strada o percorso che valorizza ogni bicicletta. Grazie all'aggiunta della protezione antiforatura, nessuno rimarrà indietro con una gomma a terra. Insieme alla camera d'aria Hermetic Plus, è un prodotto assolutamente senza preoccupazioni.

LA COMBINAISON ULTIME

Un pneu polyvalent pour tous types de routes ou de chemins qui améliore chaque vélo. Grâce à l'ajout d'une protection contre les crevaisons, personne ne sera laissé avec un pneu à plat. Associé à la chambre à air Hermetic Plus, c'est un produit totalement sans souci.



ARTICLE	EAN	ETRTO	DIMENSION	COLOR/SIDEWALL	TECHNOLOGY	WEIGHT	BAR	MAX.BAR PRICE (€)
Contact Plus								
C0101002	4019238639964	47-559	26x1.75	black reflex wire skin	SafetyPlusBreaker	1040g	3,0 4,0	42,99
C0101004	4019238639940	32-622	28x1 1/4x1 3/4	black reflex wire skin	SafetyPlusBreaker	750g	5,0 6,0	42,99
C0101005	4019238639933	37-622	28x1 3/8x1 5/8	black reflex wire skin	SafetyPlusBreaker	980g	4,0 6,0	42,99
C0101006	4019238639926	42-622	28x1.6	black reflex wire skin	SafetyPlusBreaker	1050g	3,5 5,0	42,99



UNO PENUMATICO ALL'ALTEZZA DI OGNI SFIDA, CON LA VELOCITÀ COME PUNTO DI FORZA

Contact Speed è uno slick ad alta tenuta, con battistrada micropuntinato che si distingue particolarmente sull'asfalto. Grazie ad esso le city bike, le single speed e le fitness bike godranno al contempo del suo dinamismo e di un elevato grado di comfort. Oltre che per il particolare battistrada Contact Speed convince per il suo grip, per la sua scorrevolezza e la doppia protezione contro le forature.

ALLIE CONFORT ET VITESSE

Son avantage est la vitesse. Le slick antipatinage avec profil rugueux est particulièrement adapté à l'asphalte. Les vélos de ville, à pignon fixe et d'entraînement profitent de sa dynamique tout en fournissant un grand confort. Ce pneu est ainsi en mesure de relever tous les défis. En plus de son nouveau design Vulcanette, le CONTACT Speed se distingue par son grip, sa fluidité et sa double protection anti-crevaisson.

Safety System



ARTICLE	EAN	ETRTO	DIMENSION	COLOR/SIDEWALL	TECHNOLOGY	WEIGHT	BAR	MAX.BAR PRICE (€)
Contact Speed								
C0101412	4019238774559	37-622	28x1 3/8x1 5/8	black wire skin	Double SafetySystemBreaker	500g	5,0 6,0	32,90
C0101416	4019238774504	42-622	700x42 C (40 C)	black wire skin	Double SafetySystemBreaker	590g	3,5 6,0	32,90



COMPAGNO AFFIDABILE PER IL CICLOTURISMO

Ride Tour è a proprio agio su ogni tipo di fondo, è un vero polivalente. La banda centrale del battistrada ha un design continuo, a garanzia di buone proprietà di rotolamento.

UN COMPAGNON FIABILE EN RANDONNÉE

Le RIDE Tour est chez lui sur tous les terrains, c'est un véritable multitalent. Sa surface de roulement médiane continue assure de bonnes propriétés de roulement et offre en même temps suffisamment de traction ainsi qu'une grande sûreté dans les virages. Nos clients profitent de la vaste palette de tailles disponibles et de sa grande capacité de kilométrage.



ARTICLE	EAN	ETRTO	DIMENSION	COLOR/SIDEWALL	TECHNOLOGY	WEIGHT	BAR	MAX.BAR	PRICE (€)
Ride Tour									
C0101151	4019238693522	28-622	700x28C (700C)	black wire skin	Extra Puncture Belt	540g	5,0	5,5	21,99
C0101153	4019238693508	32-622	700x32C	black wire skin	Extra Puncture Belt	640g	5,0	5,5	21,99
C0101155	4019238693485	37-622	700x35C	black wire skin	Extra Puncture Belt	690g	4,0	5,0	21,99







TECH

BlackChili Compound

La miscela per copertura unica nel suo genere, prodotta solo in Germania, che rivoluzionerà gli pneumatici per biciclette! Con la BlackChili Compound il compromesso tra maggior grip e bassa resistenza al rotolamento è stato portato ai massimi livelli in assoluto. I tanti primati ottenuti nei test certificano vantaggi misurabili e registrabili sia in laboratorio che sulla strada. I polimeri di nuova generazione, il particolato carbonioso frutto di nanotecnologie e gli agenti di carica garantiscono una performance davvero unica. Rappresenta il non plus ultra nei relativi ambiti di utilizzo: dalle coperture delle MTB da downhill agli pneumatici per bici da cronometro. BlackChili Compound migliora la resistenza al rotolamento del 26 per cento e offre allo stesso tempo un grip superiore di circa il 30 per cento rispetto alle mescole di silice attivata. Inoltre, gli pneumatici realizzati con il BlackChili Compound offrono una resa chilometrica superiore e, diversamente da mescole multiple, una performance costante dal primo all'ultimo chilometro.

A korbach, en Allemagne, où se trouve le siège de notre département recherche et développement pour les pneus de vélos Continental, cela fait longtemps que nos ingénieurs se creusent la tête sur un problème fondamental concernant la structure d'un pneu. En effet, les qualités de roulement du mélange de caoutchouc d'un pneu sont définies, de façon déterminante, par l'interaction de trois facteurs: le frottement statique [adhérence], la résistance au roulement et la longévité. Le dilemme est le suivant: si on améliore l'un de ces facteurs, au moins un autre de ces facteurs va par contre se dégrader. Un pneu ayant une adhérence maximale s'use plus rapidement et roule moins vite. Inversement, si on confectionne un pneu qui est plus rapide ou qui dure plus longtemps, alors son adhérence diminue. Avec la technologie de pointe d'aujourd'hui, à savoir la gomme à silice activée, on avait déjà atteint un bon compromis. Mais nos concepteurs voulaient obtenir plus. En suivant des chemins tout nouveaux, ils ont réussi en 2008 à mettre au point un mélange de gomme révolutionnaire: c'était le premier pas vers ce que l'on connaît sous le nom de Black Chili. Ce mélange de gomme totalement nouveau est basé sur les connaissances les plus récentes fournies par la recherche sur les polymères et les matières premières.



PureGrip Compound

La miscela PureGrip è derivata da una miscela di Silice attivata ed è un buon esempio di come noi integriamo continuamente i feedback dei clienti verso il settore della ricerca e sviluppo. Questa miscela tecnologica è perfettamente declinata della miscela BlackChili Compound. Il nome PureGrip fa esattamente ciò che dice: un grip e una durezza incredibilmente superiori sono le caratteristiche distintive di questo compound. Utilizziamo la PureGrip sui nostri articoli della linea Performance e sulla gamma mountain bike.

Fabriquée à partir d'un composé de silice activée, le mélange de gomme PureGrip est la parfaite illustration de la façon dont nous prenons en compte les retours de nos clients dans nos efforts de recherche et développement. Cette technologie est une alternative au mélange de gomme BlackChili. Son nom, "PureGrip", est on ne peut plus explicite: ce composant garantit une parfaite adhérence et une durabilité exceptionnelle. Nous utilisons PureGrip dans les produits de notre gamme Performance pour les vélos de route et VTT.



PolyX Breaker™

Resistente alla foratura. Con il PolyX Breaker® applichiamo il know-how acquisito in ambito automobilistico nel segmento motociclistico agli pneumatici per biciclette: sugli pneumatici per autovettura il poliestere viene utilizzato da anni, con grande successo ed esiti molto positivi. Estremamente resistente, la fibra di poliestere viene tessuta a maglie strette incrociate; in questo modo si raggiunge un'elevata densità del tessuto che rende il PolyX Breaker® non solo resistente alla perforazione da parte di corpi estranei ma anche particolarmente protettivo verso le forature.

Résistant aux perforations et aux coupures. Avec PolyX Breaker®, le savoir faire automobile est appliqué au domaine du vélo: le polyester est, depuis des années utilisé avec succès dans les pneus voitures et à fait ses preuves à de nombreuses reprises. Les fibres de polyester extrêmement résistantes sont étroitement et finement tissées en croix. De la sorte, on obtient un réseau très dense, qui rend le PolyX Breaker® non seulement résistant aux corps étrangers, mais également solide face aux perforations. Là aussi, la résistance au roulement n'est pas non plus affectée par PolyX Breaker®.

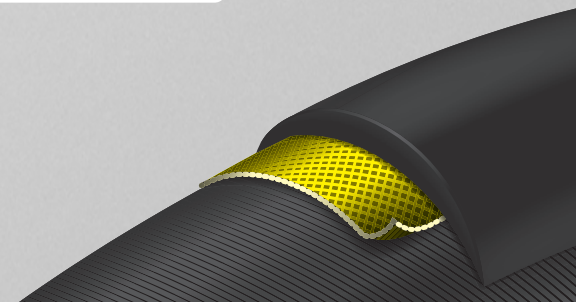

NyTech Breaker

Una tecnologia antiforatura strutturata con fibre di nylon protettive. È simile al Kevlar ma con una bassa resistenza al rotolamento e con un peso ridotto.

Une technologie de protection anti crevaisons faite de fibres de nylon - protégeant comme le Kevlar, mais avec une faible résistance au roulement, sans en augmenter les poids.

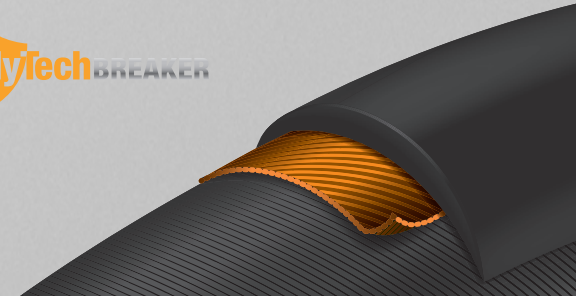

Vectran™ Breaker

Vectran™ viene prodotto dal polimero a cristalli liquidi Vectra. Si ottiene un filato termoplastico a fibre multiple. Questo tessuto in parte cristallino è più resistente al taglio rispetto all'aramide, è dotato di una resistenza alla trazione cinque volte superiore dell'acciaio ed è allo stesso tempo più leggero di un corrispondente filo di nylon. Vectran™ mantiene queste caratteristiche anche alle condizioni climatiche più ostili.

La référence en matière de protection anti-crevaisson. Vectran™ est un fil high-tech synthétique dont le modèle est pris dans la nature. Comme la soie d'araignée, Vectran™ est un polymère de cristaux liquide [LPC]. Vectran™ est tissé à partir du polymère à cristaux liquides Vectra et retravaillé en un réseau multifibres. La soie d'araignée et le composé Vectran™ possèdent une énorme résistance aux déchirures pour un poids très limité. Exactement les caractéristiques qui conviennent pour être utilisées en dispositif anti-crevaisson dans un pneu Continental. Vectran™ Breaker est plus léger, plus flexible et protège encore mieux des coupures qu'une protection anti-crevaisson en Nylon. La résistance au roulement n'est pas affectée par Vectran™ Breaker.

Vectran™
BREAKER

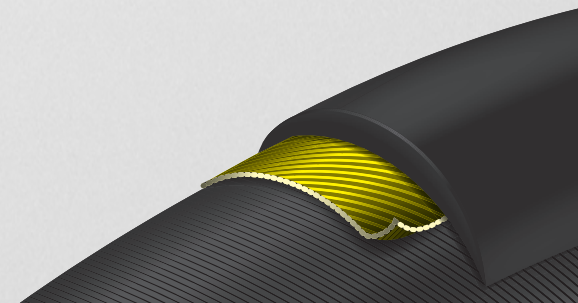

DuraSkin®

DuraSkin®. Gli pneumatici dotati di protezione delle pareti DuraSkin® devono poter affrontare qualsiasi situazione. Vengono utilizzati in condizioni estreme. Sulle biciclette dei messenger gli pneumatici strisciano sui bordi dei marciapiedi, sulle biciclette da viaggio attraversano continenti senza usurarsi, mentre nelle gare ciclistiche devono superare le prove più ardue, come ad esempio quelle della Parigi-Roubaix. Il tessuto di poliammide di alta qualità protegge efficacemente il fianco dello pneumatico e lo rende idoneo a qualsiasi situazione estrema. Questi pneumatici sono contraddistinti da tutti gli altri dal fianco di colore marrone.

Prêt pour rouler dans les pires conditions. Les pneus équipés de la protection DuraSkin® sur les flancs sont prêts pour avoir la vie dure. Ils peuvent être utilisés dans les conditions les plus extrêmes. Les pneus des vélos de coursiers frottent sur les bords de trottoirs, durant les randonnées ils sillonnent les continents sans s'user, pendant des courses ils doivent être d'une solidité à toute épreuve, comme lors du Paris-Roubaix. Le tissage en polyamide de très haute qualité protège efficacement les flancs du pneu et prémunissent le pneu contre tous les aléas. Ces pneus se distinguent du tout-venant par leurs flancs marron.

 **DuraSkin®**

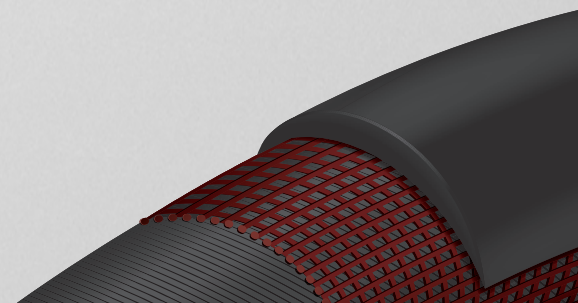

EXTRA PunctureBelt

Assieme ai fianchi in gomma rinforzata questa fettuccia costituisce un'elevata protezione contro forature e abrasioni. Disponibile in versione di pneumatico compatto con una forte propensione per la durezza.

Tous ceux qui recherchent un compagnon de tous les jours fiable choisiront un pneumatique avec EXTRA PunctureBELT. Ce dispositif de sécurité en caoutchouc robuste, combiné avec les flancs du pneu renforcés de caoutchouc, assure un haut niveau de protection contre les crevaisons et l'abrasion des flancs. Lorsque la longévité est l'objectif principal, il existe également une version pneu plein.

EXTRA PunctureBELT

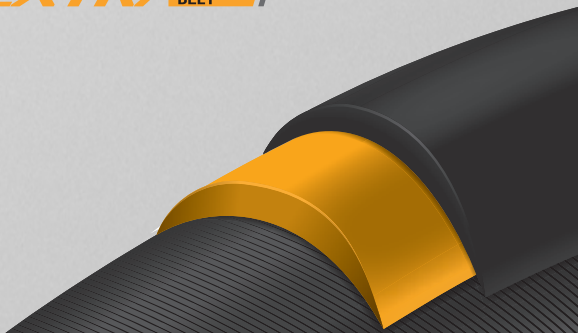

SafetySystem

Resistente alle forature e ai tagli, ma allo stesso tempo leggero e flessibile, lo pneumatico si adatta meglio al fondo stradale. Assicura caratteristiche di guida molto votate al comfort.

Résistant aux perforations et aux coupures tout en restant léger et souple, le pneu s'adapte mieux au terrain pour une tenue de route des plus agréables.

Safety System

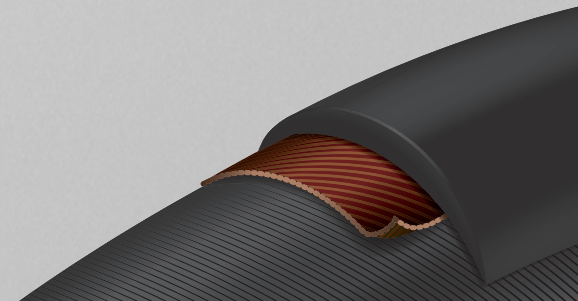

SafetyPlus Breaker

Sviluppato specialmente per le e-bike fino a 50 km/h, combiniamo il nostro SafetySystem Breaker con una gomma ad alta flessibilità. Il risultato è un Breaker estremamente resistente ai tagli e alle perforazioni, con una resistenza al rotolamento sorprendentemente bassa, grazie alla sua elevata elasticità. Questo conserva l'energia e l'inerzia. L'accelerazione rapida così come l'alta velocità di esecuzione delle curve non sono un problema per il Breaker. È lo specialista per le e-bike veloci e per le bici a noleggio.

Pour les E-bikes, nous avons combiné le SafetySystem Breaker avec un matériau hautement élastique. Le résultat est une enveloppe extrêmement résistante aux coupures et aux crevaisons qui, grâce à sa grande élasticité, offre surtout une faible résistance au roulement, économisant la batterie et l'environnement. Il est également conforme aux exigences de plus grande vitesse des E-bikes, pouvant aller jusqu'à 50 km/h. Il est également adapté pour le couple d'accélération plus élevé des vélos électriques ainsi que les vitesses plus rapides dans les virages. Le pneu spécial pour les E-bikes rapides et les vélos de locations.

Safety 

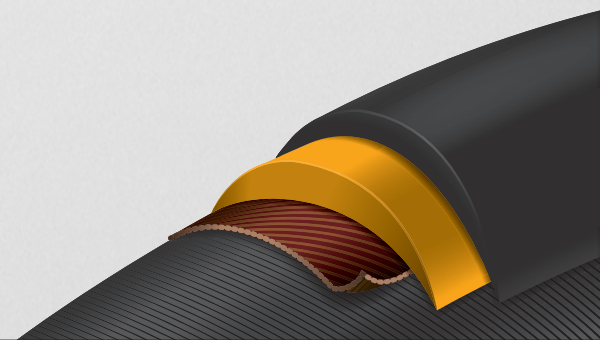

Adatto alle E-Bikes / Adapté aux E-Bikes

Per il nostro pneumatico per e-Bike ereditiamo gli oltre cento anni di esperienza con gli pneumatici per ciclomotori e moto. Tutti i nostri pneumatici da città/trekking hanno una velocità standard di almeno 25 km/h. Gli pneumatici siglati "e50" sono certificati anche per S-Pedelecs. La loro struttura di alta qualità assicura elevata protezione contro le forature, bassa resistenza al rotolamento e aggiunge un'alta durezza, grazie alla porzione motrice con struttura maggiorata.

Pour mettre au point notre pneu E-Bike nous avons tiré profit de notre expérience de plus de 100 ans dans le domaine du pneu cyclomoteur et moto. Tous nos pneus pour vélos de ville et trekking ont été conçus en fonction d'une vitesse minimum de 25 km/h. Ces pneus portant l'indication e50 sont également certifiés pour S-Pedelecs. Avec leur structure de haute qualité, la protection contre les crevaisons est élevée et la résistance au roulement faible préservant ainsi le pneu d'une usure prématurée créée par la force d'entraînement supplémentaire.



Lazer Grip

Lazer Grip, per renderti un tutt'uno con la strada. La scolpitura micropuntinata si estende fin sulle spalle dello pneumatico, per ottenere un'eccezionale tenuta in curva.

Lazer Grip, pour ne faire qu'un avec la route. La structure sculptée en micro pointe sur la partie haute des flancs procure une adhérence parfaite en courbe.



Active Comfort

Tecnologia Active Comfort. Approccio rivoluzionario nel ciclismo. Incorporata nella costruzione dello pneumatico, la tecnologia Active Comfort smorza le vibrazioni e rende più confortevole la vostra guida.

Technologie Active Comfort. L'approche révolutionnaire du cyclisme. Intégrée à la construction du pneu, la technologie Active Comfort absorbe les vibrations et rend votre conduite plus souple.



Tubeless Ready

Il nostro pneumatico Tubeless Ready [TR] può essere usato con camera d'aria o liquido sigillante. Pneumatico e cerchio sono disegnati in modo che quando sono usati assieme si sigillano facilmente. Per motivi di sicurezza usiamo solo ruote progettate per essere Tubeless Ready. Gli pneumatici TR hanno un ulteriore design alleggerito. I loro fianchi sono meno permeabili all'aria e sono sigillati con uno speciale sigillante, per esempio il Conti RevoSealant.

Les pneus Tubeless Ready peuvent être utilisés au choix avec ou sans chambre à air. Pour être utilisé sans chambre à air, le pneu doit être étanchéifié avec un liquide préventif. Le talon révolutionnaire Tubeless Ready permet un montage simple du pneu sur la jante. Tous les pneus VTT Continental des gammes ProTction et Performance sont Tubeless Ready. Pour un résultat d'étanchéité parfaite, nous recommandons l'utilisation du préventif Continental RevoSealant.



ProTecton

Le nuove carcasse Continental ProTecton sono state ulteriormente migliorate: la fettuccia anti-foratura è stata applicata in modo uniforme su tutto l'arco di circonferenza dello pneumatico, così da renderlo particolarmente resistente alle lesioni e alle perforazioni di corpi estranei. Rispetto ai già apprezzati predecessori in DuraSkin® le carcasse ProTecton pesano il 25 per cento in meno e offrono il 30 per cento di protezione in più dalle forature. Migliorate sono anche la resistenza al rotolamento e le capacità di assorbire i colpi, che completano le qualità assolute della tecnologia "made in Germany" di questi prodotti. Versatili e universali, le carcasse ProTecton convincono anche grazie alla mescola BlackChili Compound e al design accattivante dei fianchi. Il nuovo tallone Revolution permette di utilizzarle come coperture tubeless ready; in questo caso per ottenere la migliore efficienza è consigliato l'utilizzo del nuovo sigillante Continental RevoSealant.

Les nouvelles carcasses Continental ProTecton n'ont jamais eu aussi belle allure. La bande de protection supplémentaire contre la crevaison la rend particulièrement résistante et insensible aux lésions ou à la pénétration de corps étrangers. Bande de roulement et flancs sont protégés de la même manière. Elles sont pourtant plus légères de 25% et assurent une protection anti-crevaison supérieure de 30% par rapport à leurs prédécesseurs armés de DuraSkin®. Par ailleurs, elles améliorent une fois de plus la résistance au roulement et l'amortissement. La nouvelle technologie "made in Germany" leur permet même de résister aux "trails" les plus durs du monde. Et elles ont encore un atout en poche: d'usage universel, elles séduisent de surcroît par le BlackChili Compound et le design attrayant des flancs. Le nouveau talon Revolution Tubeless Ready facilite l'utilisation en pneu Tubeless Ready. Pour des résultats idéaux de colmatage et de mise en oeuvre, nous recommandons d'utiliser le nouveau produit d'étanchéité Continental RevoSealant.



ShieldWall System

Il sistema ShieldWall unisce in modo ottimale alta protezione contro le forature, bassa resistenza al rotolamento e peso contenuto. Questo grazie a un ulteriore strato di protezione totale contro le forature, costituito da un tessuto con trama finemente intrecciata. Questo conferisce allo pneumatico elevata resistenza contro forature e lacerazioni. Nonostante il tessuto aggiuntivo, lo pneumatico ha ottime proprietà di smorzamento dei colpi e un alto grado di flessibilità per adattarsi perfettamente al terreno. Il rivoluzionario tallone tubeless ready permette un'installazione facile e semplice dello pneumatico. Per ottenere i migliori risultati nella sigillatura e nell'utilizzo si consiglia l'uso del sigillante Continental RevoSealant.

Le ShieldWall system se caractérise par la combinaison optimale d'une haute protection contre les crevaisons et d'une faible résistance au roulement, avec un faible poids. Ceci est rendu possible grâce à une couche supplémentaire de protection en tissu finement tissé. Cela donne au pneu une grande résistance aux crevaisons et aux coupures. Malgré sa couche supplémentaire, le pneu a une très bonne capacité d'amortissement et un degré élevé de souplesse pour s'adapter à tout type de terrain. Le révolutionnaire tubeless ready permet un montage du pneu simple et facile. Pour obtenir de meilleurs résultats en matière d'étanchéité et d'utilisation, nous recommandons l'utilisation du nouveau produit d'étanchéité Continental RevoSealant sealant.



Performance

PureGrip è la tecnologia di mescola utilizzata esclusivamente sulle coperture destinate alle alte prestazioni. Il nome parla da solo e unisce un'aderenza superiore e grande durevolezza. Non lasciare mai nessun ciclista nei guai è stato uno dei principali obiettivi a cui si è puntato nel momento in cui questa nuova mescola è stata sviluppata e poi prodotta, presso il nuovo stabilimento Continental in Cina. La Performance è applicata su una robusta carcassa in nylon da 60 TPI (fili per pollice) in modo da consegnare una copertura affidabile, resistente e adatta a chiudere a tenuta lo pneumatico di tipo tubeless, senza camera d'aria, assieme al liquido sigillante Conti RevoSealant. Da parte loro, i talloni pieghevoli in morbida ma robusta aramide assicurano una tenuta salda sul cerchio. Gli pneumatici con mescola Performance sono qualitativamente allineati agli articoli simili prodotti dalla concorrenza asiatica, per questo offrono al bike dilettante ed ambizioso una conveniente alternativa siglata "Continental".

PureGrip est une technologie mixte issue de la dernière gamme de qualité performance. Son nom des plus éloquentes n'est pas sans évoquer accroche et longévité. Particulièrement solide et adhérent, le mélange de caoutchouc est l'allié idéal de tout cycliste, une caractéristique qui répond ainsi à l'un des objectifs principaux fixés pour le développement de ce produit de la nouvelle usine chinoise de Continental. Grâce à une robuste carcasse en nylon 60 TPI alliée à du caoutchouc haute qualité, cette technologie permet une emprise excellente et un colmatage tubeless des pneus à l'aide du RevoSealant "Tubeless Ready" de Conti. La tenue sur la jante est garantie par une tringle souple en aramide. Grâce à ces matériaux de pointe, ces pneus peuvent se mesurer à leurs concurrents asiatiques tout en représentant pour les ambitieux amateurs de vélo une alternative peu onéreuse signée Continental.



Bicycle Tubes



MTB 29

Tour 28

Cross 28

Race 28



TPU Tube 28"

ARTICLE	EAN	NEW	DESCRIPTION	ETRTO	DIMENSION	PRICE (€)
MTB Bicycle Tubes						
C0181631	4019238556711		MTB 26	47-559 > 62-559	S42	8,99
C0182311	4019238619591		MTB 27.5	47-584 > 62-584	S42	8,99
C0180015	4019238008067		MTB 27.5 Wide	65-584 > 70-584	S42	10,99
C0182181	4019238557084		MTB 28 / 29 inch	47-622 > 62-662	S42	8,99
C0182191	4019238557091		MTB 28 / 29 inch	47-622 > 62-662	S60	9,99
Tour Bicycle Tubes						
C0182031	4019238556940		Tour 28 All	32-622 > 47-622 / 42-635	S42	8,99
Cross Bicycle Tubes						
C0181941	4019238556872		Cross 28	32-622 > 47-622	S42	8,99
C0181951	4019238556889		Cross 28	32-622 > 47-622	S60	9,99
Race Bicycle Tubes						
C0181781	4019238556780		Race 28	20-622 > 25-630	S42	8,99
C0181791	4019238556797		Race 28	20-622 > 25-630	S60	9,99
C0180000	4024066568133		Race 28	20-622 > 25-630	S80	10,99
C0181821	4019238556803		Race 28 Light	20-622 > 25-630	S42	10,99
C0181831	4019238556810		Race 28 Light	20-622 > 25-630	S60	12,99
C0181871	4019238556827		Race 28 Light	20-622 > 25-630	S80	13,99
C0181881	4019238556834		Race 28 Supersonic	20-622 > 25-630	S42	19,50
C0181891	4019238556841		Race 28 Supersonic	20-622 > 25-630	S60	19,50
C0181921	4019238556858		Race 28 Wide	25-622 > 32-630	S42	8,99
C0181931	4019238556865		Race 28 Wide	25-622 > 32-630	S60	9,99
C0182621	4019238057911	new	TPU Tube 28"	25-622 > 35-622	SV60	29,95



Tubular Kit



Tube bag



Conti RevoSealant

ARTICLE	EAN	DESCRIPTION	WEIGHT	PRICE (€)
Tubular kit				
C0149091	4019238105322	Rim cement for aluminium rims (box of 12 tubes)	tube 25g	5,50
C0149092	4019238105339	Rim cement for aluminium rims	can 350g	33,90
C0140016	4024066441405	Rim cement for carbon rims (box of 12 tubes)	tube 25g	5,50
C0140017	4024066441412	Rim cement for carbon rims	can 200g	24,90
Tube bag				
C0100388	4024066508061	Tube bag with Race 28 S42 tube and 2 tire lever race	160g	12,99
C0101026	4024066653112	Tube bag with MTB 29 tube S42 and 2 tire levers MTB	320g	12,99
Sealant				
C0140044	4019238558913	Continental RevoSealant	240ml	14,90
C0140050	4019238585278	Continental RevoSealant	1.000ml	38,90
Valve extension				
C0149690	4019238105353	Exchangeable presta valve insert (bag of 10 pcs)	10 pcs	10,00
C0140030	4024066549170	Valve extension for presta valve aluminium 30mm, 2pcs	30mm	14,90
C0140032	4024066549194	Valve extension for presta valve aluminium 40mm, 2pcs	40mm	14,90
C0140034	4024066549217	Valve extension for presta valve aluminium 60mm, 2pcs	60mm	15,90

PEdALED

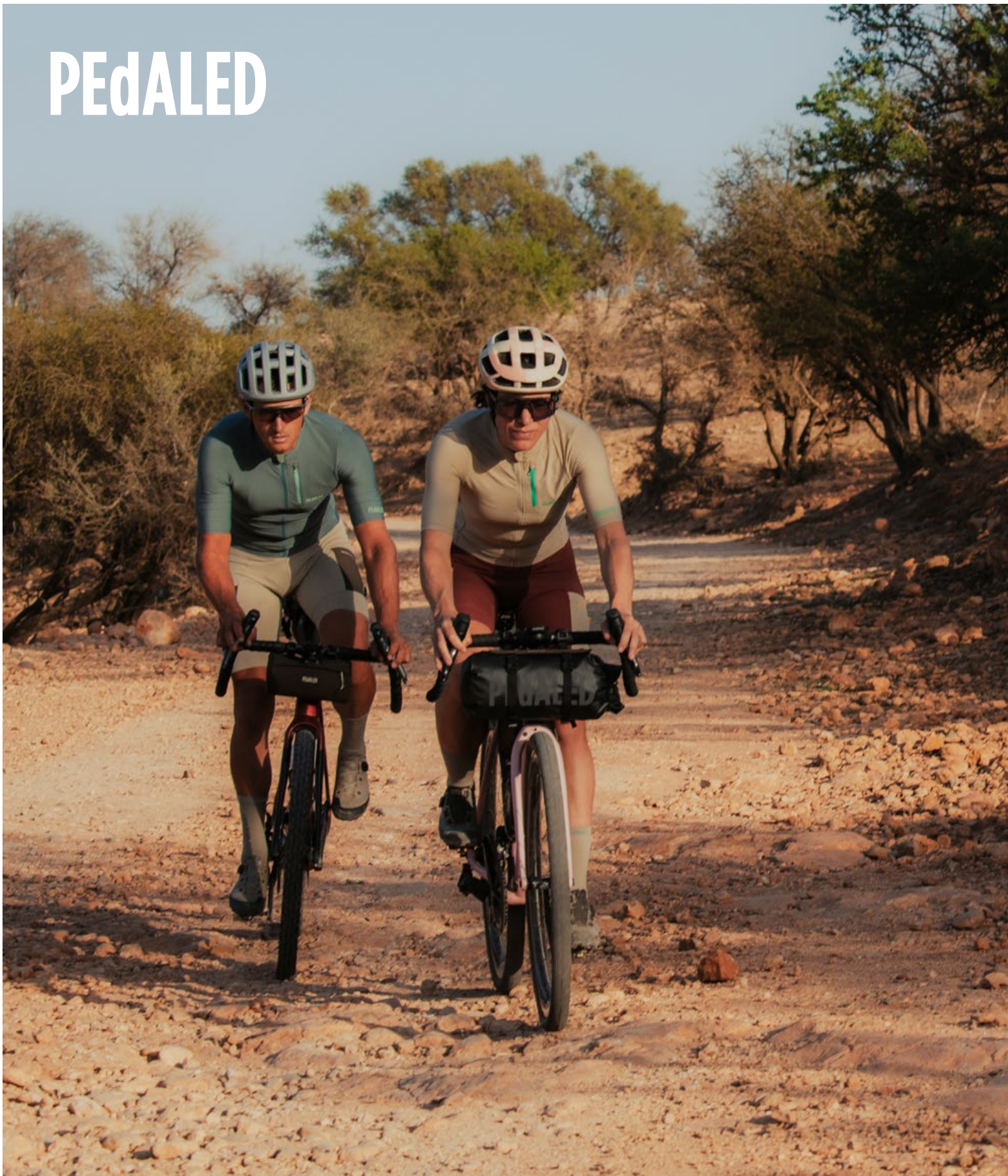



Per qualsiasi informazione, contattare il responsabile commerciale di riferimento:
Pour toute information, veuillez contacter le responsable des ventes concerné:

SALES AREA MANAGER ITALY

Andrea Molteni

M +39 3666211240

andrea.molteni@selleroyalgroup.com

SALES AREA MANAGER FRANCE

Terigi Synowiec

M +33 607708217

terigi.synowiec@selleroyalgroup.com

PEDALED





OVERVIEW

Selle Royal

ALL JOURNEYS SADDLES



ON ATHLETIC
€ 89,90



ON MODERATE
€ 89,90



ON RELAXED
€ 89,90



ON OPEN ATHLETIC
€ 89,90



ON OPEN MODERATE
€ 89,90



ON OPEN RELAXED
€ 89,90



RESPIRO ATHLETIC
€ 79,90



RESPIRO MODERATE
€ 79,90



RESPIRO RELAXED
€ 79,90



new

LOOKIN ATHLETIC
€ 79,90



new

LOOKIN MODERATE
€ 79,90



new

LOOKIN RELAXED
€ 79,90



new

LOOKIN EVO ATHLETIC
€ 84,90



new

LOOKIN EVO MODERATE
€ 84,90



new

LOOKIN EVO RELAXED
€ 84,90

ADVENTURE TIME SADDLES



EXPLORA ATHLETIC
€ 69,90



EXPLORA MODERATE
€ 69,90



EXPLORA RELAXED
€ 69,90



VAIA ATHLETIC
€ 69,90



VAIA MODERATE
€ 69,90



VAIA RELAXED
€ 69,90

URBAN LIFE SADDLES



ELLIPSE ATHLETIC
€ 54,90



ELLIPSE MODERATE
€ 54,90



ELLIPSE RELAXED
€ 54,90



new

VIVO ATHLETIC
€ 54,90



new

VIVO MODERATE
€ 54,90



new

VIVO RELAXED
€ 54,90



FREEWAY FIT ATHLETIC
€ 44,90



FREEWAY FIT MODERATE
€ 44,90



FREEWAY FIT RELAXED
€ 44,90

Selle Royal

URBAN LIFE SADDLES



FLOAT ATHLETIC
€ 44,90



FLOAT MODERATE
€ 44,90



FLOAT RELAXED
€ 44,90



AVENUE ATHLETIC
€ 39,90



AVENUE MODERATE
€ 39,90



AVENUE RELAXED
€ 39,90



DRIFTER STRENGTEX
RELAXED
€ 54,90



DRIFTER PLUS RELAXED
€ 54,90



ONDINA RELAXED
€ 34,90



HOLLAND RELAXED
€ 29,90



WITCH RELAXED
€ 19,90

KIDS SADDLES



new

EXPLORA JUNIOR Small
€ 24,90



new

EXPLORA JUNIOR Medium
€ 24,90



new

EXPLORA JUNIOR Large
€ 24,90

SADDLES BAGS



MEDIUM 1,2L
€ 24,90



LARGE 2,0L
€ 34,90



EXTRA LARGE 7,0L
€ 69,90

SEAT COVERS



ROYALGEL™ SMALL
€ 19,90



ROYALGEL™ LARGE
€ 19,90



SLOW FIT FOAM SMALL
€ 19,90



SLOW FIT FOAM LARGE
€ 19,90

REMED SADDLES



REMED SPORT
ATHLETIC
€ 26,90



REMED TREKKING
MODERATE
€ 26,90



REMED CITY
RELAXED
€ 26,90



REMED RACE LIGHT
ATHLETIC
€ 99,90



REMED RACE
ATHLETIC
€ 39,90



REMED COMFORT RACE
ATHLETIC - Black
€ 39,90



REMED COMFORT RACE
ATHLETIC - Brown
€ 39,90

ROAD SADDLES



VENTO ARGO 00
ADAPTIVE
140mm/150mm
€ 399



VENTO ARGO R1
ADAPTIVE
140mm/150mm
€ 299



VENTO ARGO R3
ADAPTIVE
140mm/150mm
€ 259



VENTO ANTARES R1
ADAPTIVE
140mm/150mm
€ 299



VENTO ANTARES R3
ADAPTIVE
140mm/150mm
€ 259



TEMPO ALIANTE R1
ADAPTIVE
145mm/155mm
€ 299



TEMPO ALIANTE R3
ADAPTIVE
145mm/155mm
€ 259



VENTO ARGO 00
140mm/150mm
€ 299



VENTO ARGO R1
140mm/150mm
€ 199



VENTO ARGO R3
140mm/150mm
€ 149



VENTO ARGO R5
140mm/150mm
€ 109



TEMPO ARGO R1
150mm/160mm
€ 199



TEMPO ARGO R3
150mm/160mm
€ 149



TEMPO ARGO R5
150mm/160mm
€ 109



VENTO ANTARES 00
140mm/150mm
€ 299



VENTO ANTARES R1
140mm/150mm
€ 199



VENTO ANTARES R3
140mm/150mm
€ 149



VENTO ANTARES R5
140mm/150mm
€ 109

ROAD SADDLES



TEMPO ALIANTE R1
145mm/155mm
€ 199



TEMPO ALIANTE R3
145mm/155mm
€ 149



TEMPO ALIANTE R5
145mm/155mm
€ 109



ARIONE 00
€ 299



ARIONE R1
126mm/140mm
€ 199



ARIONE R3
126mm/140mm
€ 149



ARIONE CLASSIC
€ 129



ARIONE R1 OPEN
132mm/142mm
€ 199



ARIONE R3 OPEN (Black)
132mm/142mm
€ 149



ARIONE R3 OPEN (White)
132mm/142mm
€ 149

TRIATHLON SADDLES



new

TRANSIRO AERIS LD R1
ADAPTIVE
€ 299



new

TRANSIRO AERIS LD R3
ADAPTIVE
€ 259



new

TRANSIRO AERIS SD R1
ADAPTIVE
€ 299



new

TRANSIRO AERIS SD R3
ADAPTIVE
€ 259



TRANSIRO AERIS LD R1
€ 199



TRANSIRO AERIS LD R3
€ 149



TRANSIRO AERIS LD R5
€ 109



TRANSIRO AERIS SD R1
€ 199



TRANSIRO AERIS SD R3
€ 149



TRANSIRO AERIS SD R5
€ 109

OFF-ROAD SADDLES



new

TERRA ARGO X1
ADAPTIVE
140mm/150mm
€ 299



new

TERRA ARGO X3
ADAPTIVE
140mm/150mm
€ 259



VENTO ARGO X1
140mm/150mm
€ 199



VENTO ARGO X3
140mm/150mm
€ 149



VENTO ARGO X5
140mm/150mm
€ 109



TERRA ARGO X1
140mm/150mm/160mm
€ 199



TERRA ARGO X3
140mm/150mm/160mm
€ 149



TERRA ARGO X5
140mm/150mm/160mm
€ 109



TERRA ALPACA X5
+ CARRIAGE KIT
€ 99



GRAVITA ALPACA X5
+ CARRIAGE KIT
€ 89



TERRA AIDON X1
145mm/160mm
€ 179



























TERRA AIDON X3
145mm/160mm
€ 139



TERRA AIDON X5
145mm/160mm
€ 89

ROAD SHOES

 new	 new			
VEGA CARBON Coal Black/Black € 390	VEGA CARBON White/White € 390			
				
VENTO INFINITO KNIT CARBON 2 Black/Black** € 380	VENTO INFINITO KNIT CARBON 2 Coral/Black** € 380	VENTO INFINITO CARBON 2 Black/Black** € 380	VENTO INFINITO CARBON 2 White/Black** € 380	
	 new			
VENTO POWERSTRAP AEROWEAVE CARBON White/White € 350	VENTO POWERSTRAP AEROWEAVE CARBON Light Violet/Neon Green € 350			
				
TEMPO DECOS CARBON Black/Black € 290	TEMPO DECOS CARBON Aubergine** € 290	TEMPO DECOS CARBON Iridescent Blue € 290	TEMPO DECOS CARBON White/White Available also in WIDE version € 290	
 new	 new	 new		
TEMPO BEAT Black/Black € 179	TEMPO BEAT White/Orange € 179	TEMPO BEAT Sage Green/Desert € 179		
				
TEMPO OVERCURVE R4 White/Black € 219	TEMPO OVERCURVE R4 Navy/Black** € 219	TEMPO OVERCURVE R4 Black/Black Available also in WIDE version € 219	TEMPO OVERCURVE R4 Copper/Black Iridescent** € 219	TEMPO OVERCURVE R4 Beetle/Black Iridescent** € 219
				
VENTO OMNA Black/Black € 159	VENTO OMNA White/Black Available also in WIDE version € 159	VENTO OMNA Red/Black** € 159	VENTO OMNA Metallic Gun Metal/Black** € 159	VENTO OMNA Cherry/Black** € 159

(**) Fino ad esaurimento scorte | Jusqu'à épuisement des stocks

ROAD SHOES



TEMPO POWERSTRAP R5
Black/Black
€ 129



TEMPO POWERSTRAP R5
White/Black
€ 129



TEMPO POWERSTRAP R5
Reflective Grey/Black
€ 129



TEMPO ARTICA R5 GTX
Black/Black
€ 269



TEMPO ARTICA R5 GTX
White/Grey
€ 269

TRIATHLON SHOES



TRANSIRO HYDRA
AEROWEAVE CARBON
White/Silver
€ 290



TRANSIRO HYDRA
AEROWEAVE CARBON
White/Red-Blue
€ 290



TRANSIRO HYDRA
White/Black
€ 149



TRANSIRO HYDRA
White/Metallic Red
€ 149



TRANSIRO HYDRA
White/Metallic Blue
€ 149

OFF-ROAD SHOES



VENTO FEROX CARBON
Black/Black
€ 299



new

VENTO FEROX CARBON
Mud/Grape
€ 299



new

VENTO FEROX CARBON
Lime/Purple
€ 299



VENTO FEROX CARBON
Lilac/White**
€ 299



VENTO PROXY
Black/Black
€ 229



VENTO PROXY
Coral/Purple**
€ 229



VENTO PROXY
White/White
€ 229



new

VENTO PROXY
Light Lilac/Lime
€ 229



TERRA ATLAS
Grey/Black
€ 159



TERRA ATLAS
Black/Black
€ 159



TERRA ATLAS
Army
€ 159



TERRA ATLAS
Pink Grape
€ 159

OFF-ROAD SHOES



TERRA POWERSTRAP X4
Mud/Caramel**
€ 159



TERRA POWERSTRAP X4
Black/Black**
€ 159



TERRA ERGOLACE X2 GTX
Ice Grey/Black
€ 189



TERRA ERGOLACE X2 GTX
Anthracite/Black
€ 189



TERRA ERGOLACE X2
Black/Black**
€ 129



TERRA ERGOLACE X2
Olive/Caramel**
€ 129



TERRA ERGOLACE X2
Black/Black**
FLAT version
€ 129



GRAVITA TENSOR
Black/Black
€ 179



GRAVITA VERSOR
Grey/Mud
€ 139



GRAVITA TENSOR
Black/Black
FLAT version
€ 179



GRAVITA VERSOR
Grey/Mud
FLAT version
€ 139



TERRA ARTICA X5 GTX
Black/Black
€ 269



TERRA ARTICA X5 GTX
Purple/Black**
€ 269

HELMETS



new

KUDO HELMET
White
€ 290



new

KUDO HELMET
Black
€ 290



new

KUDO HELMET
Bronze
€ 290



new

KUDO AERO HELMET
White
€ 290



new

KUDO AERO HELMET
Black
€ 290



new

KUDO AERO HELMET
Silver
€ 290



new

KASSIS HELMET
White
€ 200



new

KASSIS HELMET
Dark Navy
€ 200



new

KASSIS HELMET
Mud/Sand
€ 200



new

KUNÉE HELMET
White
€ 380

VENTO MICROTEX TACKY BARTAPES (Thickness 2mm)



Black
€ 39,90



White
€ 39,90



Red
€ 39,90



Orange Fluo
€ 39,90



Pink Fluo
€ 39,90



Yellow Fluo
€ 39,90



Lilla Fluo
€ 39,90



Celeste
€ 39,90



Black/Celeste
€ 44,90



Black/White
€ 44,90



Black/Red
€ 44,90



Black/Grey
€ 44,90

VENTO SOLOCUSH TACKY BARTAPES (Thickness 2,7mm)



Black
€ 44,90

White
€ 44,90

Blue
€ 44,90

Green
€ 44,90

Red
€ 44,90

Pink
€ 44,90

Yellow
€ 44,90

Orange Fluo
€ 44,90

Pink Fluo
€ 44,90

Yellow Fluo
€ 44,90

Lilla Fluo
€ 44,90

Celeste
€ 44,90

Mint Green
€ 44,90

Light Grey
€ 44,90

Dark Grey
€ 44,90

TEMPO MICROTEX CLASSIC BARTAPES (Thickness 2mm)



Black
€ 19,90

White
€ 19,90

Blue
€ 19,90

Green
€ 19,90

Red
€ 19,90

Pink
€ 19,90

Yellow
€ 19,90

Orange
€ 19,90

Honey
€ 19,90

Silver
€ 19,90

Celeste
€ 19,90

TEMPO BONDCUSH CLASSIC BARTAPES
(Thickness 3mm)



Black
€ 24,90

White
€ 24,90

Honey
€ 24,90

TEMPO BONDCUSH SOFT BARTAPES
(Thickness 3mm)



Black
€ 29,90

Red
€ 29,90

TERRA SOLOCUSH TACKY BARTAPES (Thickness 3,5mm)



Light Grey
€ 44,90

Black
€ 44,90

White
€ 44,90

Red
€ 44,90

Dark Blue
€ 44,90

Green/Blue
€ 44,90

Brown
€ 44,90

COMFORTFEEL GRIPS



COMFORTFEEL GRIPS
Black
€ 29,90

COMFORTFEEL GRIPS
Kaki
€ 29,90

COMFORTFEEL GRIPS
Burgundy
€ 29,90

COMFORTFEEL GRIPS
Lavander
€ 29,90

RACEFEEL GRIPS



RACEFEEL GRIPS
Black
€ 29,90

RACEFEEL GRIPS
Kaki
€ 29,90

RACEFEEL GRIPS
Burgundy
€ 29,90

RACEFEEL GRIPS
Lavander
€ 29,90



MALLET PEDALS



MALLET DH 11
Black/Gold
€ 350



MALLET DH
Black/Black
€ 190



MALLET DH
Red/Red
€ 190



MALLET E 11
Black/Gold
€ 350



MALLET E
Black/Black
€ 190



MALLET E
Electric Blue/Blue
€ 190



MALLET E
Blue/Black
€ 190



MALLET TRAIL
Black/Black
€ 190



MALLET TRAIL
Champagne/Black
€ 190



MALLET TRAIL
Purple/Black
€ 190



MALLET 3**
Raw/Black/Blue
€ 150

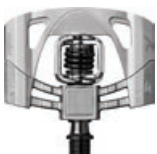

MALLET 2**
Raw/Silver/Black
€ 100



CANDY PEDALS



CANDY 11
Gold/Gold
€ 500



CANDY 7
Black/Electric Blue/Black
€ 190



CANDY 7
Black/Black
€ 190



CANDY 7
Red/Red
€ 190



CANDY 3
Black/Black
€ 150



CANDY 3
Slate Blue/Blue
€ 150



CANDY 2
Dark Grey/Black
€ 100



CANDY 2
Red/Black
€ 100



CANDY 1
Black/Black
€ 60



CANDY 1
Light Blue/Blue
€ 60



CANDY 1
Red/Red
€ 60



CANDY 1
Pink/Pink
€ 60



EGGBEATER PEDALS



EGGBEATER 11
Gold/Gold
€ 500



EGGBEATER 3
Light Blue/Electric Blue
€ 150



EGGBEATER 3
Red/Red
€ 150



EGGBEATER 3
Black/Black
€ 150



EGGBEATER 2
Black/Black
€ 100



EGGBEATER 2
Black/Green
€ 100



EGGBEATER 1
Silver/Red
€ 60



EGGBEATER 1
Silver/Black
€ 60

DOUBLE SHOT PEDALS



DOUBLE SHOT 3
Black/Black
€ 150



DOUBLE SHOT 3
Red/Black/Black
€ 150



DOUBLE SHOT 2
Black/Silver/Blue
€ 100



DOUBLE SHOT 2
Orange/Black/Orange
€ 100



DOUBLE SHOT 2
Blue/Black/Black
€ 100



DOUBLE SHOT 1
Black/Black
€ 60



DOUBLE SHOT 1
Blue/Black
€ 60



DOUBLE SHOT 1
Red/Black
€ 60



STAMP PEDALS



STAMP 11 - Small/Large
Black/Gold
€ 300



STAMP 7 - Small/Large
Black
€ 180



STAMP 7 - Small/Large
Red
€ 180



STAMP 7 - Small/Large
Electric Blue
€ 180



STAMP 7 - Small/Large
High Polish Silver
€ 190



STAMP 3 - Small/Large
Black Magnesium
€ 140



STAMP 3 - Small/Large
Silver Magnesium
€ 140



STAMP 2 - Small/Large
Raw Silver
€ 100



STAMP 2 - Small/Large
Black
€ 100



STAMP 1 GEN 2
Small/Large
Black
€ 60



STAMP 1 GEN 2
Small/Large
Red
€ 60



STAMP 1 GEN 2
Small/Large
Orange
€ 60



STAMP 1 GEN 2
Small/Large
Navy Blue
€ 60



STAMP 1 GEN 2
Small/Large
Purple
€ 60



MALLET TRAIL SHOES



MALLET TRAIL BOA®
Black/Gold
€ 220



MALLET TRAIL SPEEDLACE
Sand/Brown
€ 180



MALLET TRAIL SPEEDLACE
Green/Sand
€ 180



MALLET TRAIL LACE
Black/Black
€ 170



MALLET TRAIL LACE
White/Purple
€ 170



MALLET TRAIL LACE
Blue/Blue
€ 170

STAMP TRAIL SHOES



STAMP TRAIL BOA®
Black/Gold
€ 200



STAMP TRAIL LACE
Black/Black
€ 150



STAMP TRAIL LACE
White/Purple
€ 150



STAMP TRAIL LACE
Blue/Blue
€ 150

MALLET SHOES



MALLET BOA®
Black/Gold
€ 200



MALLET SPEEDLACE
Black/White
€ 170



MALLET LACE
Black/Red
€ 150



MALLET LACE
Grey/Blue**
Limited Edition
€ 150



MALLET LACE
Petrol/Lime**
Limited Edition
€ 150

MALLET E SHOES



MALLET E SPEEDLACE
Green/Blue**
€ 170



MALLET E LACE
Black/Blue**
€ 150



STAMP SHOES



STAMP BOA®
Black/Gold
€ 180



STAMP SPEEDLACE
Black/White
€ 150



STAMP SPEEDLACE
Purple/Teal Blue
€ 150



STAMP SPEEDLACE
Green/Orange**
€ 150



STAMP SPEEDLACE
Grey/Red**
€ 150



STAMP LACE
Black/Silver
€ 130



STAMP LACE
White/White
€ 130



STAMP LACE
Navy/Silver
€ 130



STAMP LACE
Grey/Blue**
Limited Edition
€ 130



STAMP LACE
Petrol/Lime**
Limited Edition
€ 130

STAMP STREET SHOES



STAMP STREET LACE
Black/Gold
€ 130



STAMP STREET LACE
White/Gold
€ 130

CANDY GRAVEL/XC SHOES



CANDY GRAVEL / XC LACE
Black/Black
€ 160



CANDY GRAVEL / XC LACE
White/Grey
€ 160



CANDY GRAVEL / XC LACE
Green/Dark Green
€ 160



CARBON WHEELS



new

SYNTHESIS DH 11
Carbon Single Wheel
€ 1000 front



new

SYNTHESIS DH 11
Carbon Single Wheel
€ 1400 rear



new

SYNTHESIS XCT 11
Carbon Single Wheel
€ 1000 front



new

SYNTHESIS XCT 11
Carbon Single Wheel
€ 1400 rear



new

SYNTHESIS E 11
Carbon Single Wheel
€ 1000 front



new

SYNTHESIS E 11
Carbon Single Wheel
€ 1400 rear



new

SYNTHESIS E i9 1/1
Carbon Single Wheel
€ 850 front



new

SYNTHESIS E i9 1/1
Carbon Single Wheel
€ 1150 rear



new

SYNTHESIS XCT
CB RATCHET
Carbon Single Wheel
€ 750 front



new

SYNTHESIS XCT
CB RATCHET
Carbon Single Wheel
€ 850 rear



new

SYNTHESIS E
CB RATCHET
Carbon Single Wheel
€ 750 front



new

SYNTHESIS E
CB RATCHET
Carbon Single Wheel
€ 850 rear



new

SYNTHESIS E-BIKE
Carbon Single Wheel
€ 750 front



new

SYNTHESIS E-BIKE
Carbon Single Wheel
€ 850 rear



SYNTHESIS GRAVEL
CARBON
Carbon Single Wheel
€ 750 front



SYNTHESIS GRAVEL
CARBON
Carbon Single Wheel
€ 850 rear



ALLOY WHEELS



SYNTHESIS XCT ALLOY
Alloy Single Wheel
€ 240 front



SYNTHESIS XCT ALLOY
Alloy Single Wheel
€ 360 rear



SYNTHESIS E ALLOY
Alloy Single Wheel
€ 240 front



SYNTHESIS E ALLOY
Alloy Single Wheel
€ 360 rear

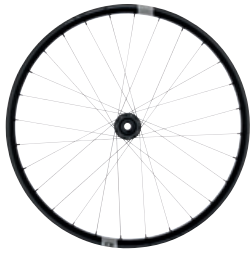

SYNTHESIS E-BIKE ALLOY
Alloy Single Wheel
€ 300 front



SYNTHESIS E-BIKE ALLOY
Alloy Single Wheel
€ 400 rear



SYNTHESIS GRAVEL ALLOY
Alloy Single Wheel
€ 240 front



SYNTHESIS GRAVEL ALLOY
Alloy Single Wheel
€ 360 rear



COBALT 2**
Alloy Wheelsets
€ 600

DROPPER SEATPOST

HIGHLINE 11
100mm
125mm
150mm
170mm
€ 400



HIGHLINE 7
100mm
125mm
150mm
170mm
200mm
€ 300



HIGHLINE 3
80mm
100mm
125mm
150mm
170mm
200mm
€ 200



HIGHLINE XC/GRAVEL
60mm
80mm
100mm
125mm
€ 250



(**) Fino ad esaurimento scorte | Jusqu'à épuisement des stocks



GRIPS



COBALT - Silver**
€ 30



COBALT - Gold**
€ 30



COBALT - Red**
€ 30



IODINE - Black
€ 30

TOOLS



TOOL S.O.S.
TT17 TWIN TUBE TOOL KIT
€ 120



TOOL S.O.S.
BC18 BOTTLE CAGE KIT
€ 100



TOOL S.O.S.
TS18 TUBE STASH TOOL
KIT € 90



TOOL S.O.S.
BC2 BOTTLE CAGE +
€ 40



TOOL S.O.S.
TS2 TUBE STASH +
€ 30



MULTI 20 - Matte Black
€ 40



MULTI 20 - Nickel
€ 40



MULTI 20 - Gold
€ 40



MULTI 20 - Matte Black/Red
€ 40



MULTI 19 - Nickel
€ 38



MULTI 19 - Gold
€ 38



MULTI 17 - Nickel
€ 30



MULTI 17 - Gold
€ 30



MULTI 13 - Matte Black
€ 28



MULTI 13 - Nickel
€ 28



MULTI 13 - Gold
€ 28



MULTI 13 - Matte Black/Red
€ 28



MULTI 10 - Nickel
€ 20



MULTI 10 - Gold
€ 20



MULTI 5 - Nickel
€ 15



MULTI 5 - Gold
€ 15



F16 - Black
€ 60



F11 - Black
€ 50



F15 - Black/Silver
€ 50



F10+ - Black/Silver
€ 40



TOOL CIGAR - Black/Silver
€ 30



TOOL SLIDER TIRE
LEVER KIT - Black
€ 10

new

ROAD



GRAND PRIX 5000 AS TR
Black/Black Reflex
Skin Foldable
€ 104,99



GRAND PRIX 5000 AS TR
Black/Cream
Reflex Skin Foldable
€ 99,99



GRAND PRIX 5000 S TR
Black/Black
Skin Foldable
€ 87,99



GRAND PRIX 5000 S TR
Black/Transparent
Foldable
€ 87,99



GRAND PRIX 5000
Black/Black
Skin Foldable
€ 74,99



GRAND PRIX 5000
Black/Transparent
Foldable
€ 74,99



GRAND PRIX 5000
Black/Cream
Foldable
€ 74,99



GRAND PRIX 4-SEASON
Black
DuraSkin Foldable
€ 74,99



GRAND PRIX
Black
Foldable
€ 49,99



GRAND SPORT RACE
Black
Foldable
€ 39,99



ULTRA SPORT III
Black
Skin Foldable
€ 29,99

TUBULAR



COMPETITION
Black
€ 130,99



SPRINTER GATORSKIN
Black
€ 84,99



SPRINTER
Black
€ 66,99



GIRO
Black/Transparent
€ 39,99

GRAVEL



TERRA SPEED PROTECTION
Black/Cream
Skin Foldable
€ 69,99



TERRA SPEED PROTECTION
Black/Transparent
Skin Foldable
€ 69,99



TERRA SPEED PROTECTION
Black/Black
Foldable
€ 69,99



TERRA TRAIL
Black/Cream
Skin Foldable
ShieldWall: € 39,99
Protection: € 69,99



TERRA TRAIL PROTECTION
Black/Transparent
Skin Foldable
€ 69,99



TERRA TRAIL
Black/Black
Skin Foldable
ShieldWall: € 39,99
Protection: € 69,99



TERRA TRAIL ShieldWall
Black/Brown
Skin Foldable
€ 39,99

MTB



KRYPTOTAL FR
Black/Black
Skin Foldable
from € 73 to € 99



KRYPTOTAL RE
Black/Black
Skin Foldable
from € 73 to € 95



ARGOTAL
Black/Black
Skin Foldable
from € 73 to € 89



XYNOTAL
Black/Black
Skin Foldable
€ 73

MTB



CROSS KING
Black
Skin Foldable
ShieldWall: € 36,90 / € 40,99
Protection: € 67,90 / € 89,99



CROSS KING PROTECTION
Black/Transparent
Skin Foldable
€ 67,90



MOUNTAIN KING
Black
Skin Foldable
ShieldWall: € 36,99 / € 40,99
ProTecton: € 69,90 / € 79,90



RACE KING
Black
Skin Foldable
ShieldWall: € 36,90
ProTecton: € 67,90



RACE KING PROTECTION
Black/Transparent
Skin Foldable
€ 67,90

URBAN



CONTACT PLUS
Black
Reflex Wire Skin
€ 42,99



CONTACT SPEED
Black
Wire Skin
€ 32,90



RIDE TOUR
Black
Wire Skin
€ 21,99

A4 SALES AGENTS

FRANCE

REGION NORD

(Haut De France / Ile de France / Haute Normandie / Champagne Ardennes / Centre)

Max Vanovershelde

M +33 662121870

maxvano59@gmail.com

REGION OUEST

(Bretagne / Basse Normandie / Pays de Loire / Poitou Charentes)

Gilles Cosperec

M +33 668698366

gsports@hotmail.fr

REGION SUD OUEST

(Aquitaine / Midi Pyrenées / Languedoc Roussillon / Limousin)

Vincent Guezennec

M +33 0614981632

vincent.guezennec@outlook.fr

REGION SUD EST

(Provence Alpes Côte d'Azur / Corse / Rhône Alpes / Auvergne / Suisse)

Pierre Bajoux

M +33 699321434

pierrebajoux@gmail.com

REGION EST

(Alsace / Lorraine / Franche Comté / Bourgogne)

Patrick Ledys

M +33 607140471

p.ledys@alecar-sports.com

SALES AREA MANAGER

Terigi Synowiec

M +33 607708217

terigi.synowiec@selleroyalgroup.com

COPYRIGHT. Tous les contenus du présent catalogue, y compris les textes, documents, logos, images, graphiques, vidéos, leur propre disposition et adaptation à l'intérieur du site, sont protégés suivant les lois du Copyright® de Selle Royal Group S.p.A. et des autres droits de la propriété intellectuelle. La reproduction, altération, modification, publication et l'utilisation, même partielle de ces contenus, quel qu'en soit l'usage, soit commercial ou non, dans tout type de format et support, ne sont pas permis sans l'autorisation expresse écrite de Selle Royal Group S.p.A. Tous les droits sont réservés.

MARQUES. Toutes les marques et logos présents dans le catalogue sont la propriété exclusive de leurs détenteurs respectifs. Toute utilisation et/ou reproduction de ceux-ci pour n'importe quel but ou moyen sont strictement et sévèrement interdits et entraîneront des poursuites suivant les lois applicables en la matière.

LIMITES DE RESPONSABILITÉ. Les contenus et les informations présents dans le catalogue sont fournis "en l'état" et périodiquement mis à jour et contrôlés. En conséquence, ils pourraient s'avérer incomplets, imprécis ou mis à jour à tout moment, ou contenir des erreurs. Selle Royal Group S.p.A. décline toute responsabilité et toute garantie concernant l'exactitude, la mise à jour, erreurs et omissions des informations et des contenus présents dans le catalogue.



BUREAU COMMERCIAL/ADMINISTRATIF

Selle Royal Group S.p.A.
Via Vittorio Emanuele, 119
36050 Pozzoleone (VI) Italy

CONTACTS

T +39 0444 461100
info@a4selection.com
www.a4selection.com

RÉCLAMATIONS ET RETOURS

Les demandes de SAV pour défaut de qualité ou de retrait doivent être effectuées dans notre B2B par un formulaire de retour:
b2x.a4selection.com/fr/returnedgoods/

SERVICE APRÈS VENTE CRANKBROTHERS

Pippo Wheels S.r.l.
Via S. Venier, 15
36100 Vicenza (VI) Italy
T +39 0444 532052
crankbrothers@pippowheels.com

GARANTIE

Les articles présentés dans ce catalogue sont couverts par **2 ANNÉES** de garantie à compter de la date d'achat

Selle Royal

SELLEROYAL.COM

fi'zi:k

FIZIK.COM



crankbrothers

CRANKBROTHERS.COM

Continental 

CONTINENTAL-TIRES.COM

PEdALED

PEDALED.COM

A4SELECTION.COM



A4 Selection



a4selection