



# SELECTION

2024

**WORKBOOK 2024**

SELEZIONE DEI MIGLIORI COMPONENTI  
E ACCESSORI PER IL CICLISMO

Selle Royal

fi'zi:k

  
crankbrothers



**BROOKS**  
18 ENGLAND 66

**KASK**

**KCO**  
eyewear



## **WORKBOOK 2024**

<b>SELLE ROYAL</b>	<b>5</b>
<b>FIZIK</b>	<b>51</b>
<b>CRANKBROTHERS</b>	<b>151</b>
<b>CONTINENTAL</b>	<b>227</b>
<b>BROOKS ENGLAND</b>	<b>263</b>
<b>KASK</b>	<b>339</b>
<b>KOO</b>	<b>387</b>
<b>OVERVIEW</b>	<b>407</b>

# Selle Royal





**SELLE ROYAL**

## Product categories



### All Journeys Riding Everywhere

Il top di gamma di Selle Royal: questi prodotti sono perfetti per coloro che non vogliono scendere a compromessi, tanto negli spostamenti urbani quanto nelle avventure fuoriporta. La gamma All Journeys combina materiali di prima qualità e tecnologie innovative per garantire comfort e durata ottimali, senza rinunciare ad un design accattivante.

Ces produits Selle Royal, les meilleurs de leur catégorie, sont adaptables et parfaits pour ceux qui ne veulent pas lésiner sur l'excellence, que ce soit en ville ou à l'extérieur. Avec la gamme All Journeys, les matériaux de première qualité et les technologies innovantes permettent d'obtenir le meilleur en matière de confort, de design et de durabilité.



### Adventure Time Exploring Outdoors

Le compagne di viaggio per le tue escursioni. Pedali per divertirti, per fare sport o per andare lontano? Questa gamma di selle è studiata per il tuo tempo libero in bicicletta. Tutti i modelli sono adatti a lunghe uscite e a diversi tipi di terreno, per esplorare la natura a modo tuo.

Une bouffée d'air frais pour toutes les excursions. Que vous roulez pour le plaisir, pour la forme ou pour partir en excursion loin de chez vous, cette gamme de selles donne le meilleur d'elle-même pour vous aider à profiter de votre temps libre à vélo. Tous ces modèles sont adaptés aux longues sorties et à différents types de terrains, pour que vous puissiez explorer la nature à votre guise.



### Urban Life Moving in the City

Comfort ottimale per pedalare in città. Modelli studiati per accompagnarti nella vita di tutti i giorni, nei brevi tragitti o nei lunghi spostamenti in bici nella giungla urbana. Lasciati sorprendere dalla comodità, dallo stile e dall'affidabilità.

Le confort ultime pour le vélo en ville. Toute selle appartenant à cette gamme deviendra votre alliée de confiance au quotidien. Qu'il s'agisse de courtes balades ou de longs trajets, d'un style moderne ou d'une grande fiabilité, choisissez parmi de nombreux modèles en fonction de vos besoins en ville.

# New packaging

Nuovo logo  
Nouveau logo

La sella si presenta  
La selle se présente elle-même

I vantaggi di prodotto sono evidenziati  
in modo chiaro e sintetico

Les principaux avantages du produit  
sont mis en évidence de manière claire  
et concise

Le linee identificano il contesto di  
utilizzo per aiutare il consumatore ad  
orientarsi nella scelta della sella

La gamme de produits définit  
l'utilisation de la selle afin de guider  
le consommateur vers le bon choix  
de selle



La riding position è più evidente  
e comprensibile  
La position de conduite est plus claire  
et plus facile à comprendre

30 Day Comfort Guarantee  
evidenziata sul fronte  
La Garantie de confort de 30 jours  
est mise en évidence sur l'avant

Nuovi colori per nuove linee  
De nouvelles couleurs pour  
de nouvelles gammes

Struttura apribile che permette di  
includere più informazioni sul prodotto  
L'emballage peut être ouvert pour  
inclure plus d'informations sur  
le produit

Spiegazione dei vantaggi specifici  
della sella e delle caratteristiche di  
prodotto che li determinano

Explication des principaux avantages  
de la selle et des caractéristiques des  
produits réutilisables



Nuovi testi in 6 lingue, linguaggio  
più facile da comprendere e più  
coinvolgente

Nouveaux textes en 6 langues, avec un  
contenu plus facile et plus engageant

Spiegazione del concetto della riding  
position e dell'approccio unisex

Explication du concept de position de  
conduite et de l'approche unisexe

Indicazioni di sostenibilità e  
riciclabilità: packaging realizzato in  
carta al 100% riciclata e riciclabile

Indications de durabilità et de  
recyclage : emballage  
fabriqué à partir de papier 100%  
recyclé et recyclable

Indicazione del Made in Italy  
Indication du Made in Italy

## Riding positions

La posizione di guida è il fattore cruciale nella scelta della sella. A seconda dello stile di guida varia, infatti, il modo in cui le ossa del bacino poggiano sulla sella, influenzando quindi il livello di comfort generale. I prodotti di Selle Royal sono progettati ergonomicamente per accogliere le diverse larghezze di ossa ischiatiche e soddisfare le esigenze anatomiche di donne e uomini, garantendo la riduzione della pressione nelle zone più sensibili.

Scegli la tua corretta posizione di guida tra **45° (Athletic)**, **60° (Moderate)** e **90° (Relaxed)** e goditi le tue uscite in bici senza pensieri!

La position de conduite est un facteur crucial dans le choix de la selle optimale. En fonction de votre manière de rouler, la façon dont vos ischions reposent sur la selle varie considérablement et cela affecte par conséquent le niveau de confort. Les selles Selle Royal sont conçues de manière ergonomique pour s'adapter à toutes les largeurs d'ischions et satisfaire les besoins anatomiques des hommes et des femmes, en garantissant un soulagement de la pression dans les zones les plus sensibles.

Choisissez votre position de conduite entre **45° (Athletic)**, **60° (Moderate)** et **90° (Relaxed)** pour profiter de vos sorties sans douleur!

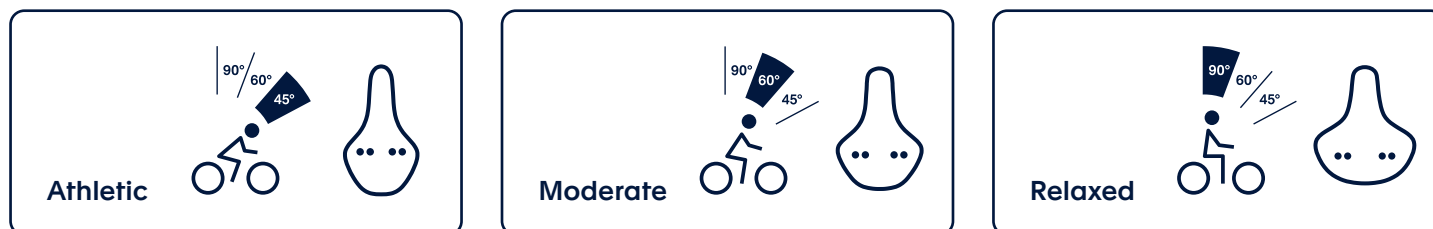

## 30 Day Comfort Guarantee

Selle Royal offre una Garanzia Comfort di 30 giorni su tutti i prodotti. Anche il nuovo packaging presenta uno specchietto sul fronte per informare i consumatori di questa opportunità: assicurati di assistere i tuoi clienti perché possano beneficiare di questo vantaggio!

Selle Royal offre une garantie de confort de 30 jours sur tous les produits. Le nouvel emballage affiche également clairement cette information sur le devant : assurez-vous d'informer correctement vos clients de cet avantage afin qu'ils puissent en profiter!





# Product features

## Royal Comfort



### ROYALGEL™

Superiore a qualsiasi altra imbottitura grazie alla sua formulazione unica, Royalgel™ è studiato per garantire il massimo livello di comfort. Durevole e versatile, questa tecnologia assorbe la pressione e la distribuisce su tutta la superficie della sella, garantendo un supporto ottimale anche nelle pedalate più lunghe.

Supérieur à tout autre matériau de rembourrage, le Royalgel™ offre le plus haut niveau de confort grâce à sa formulation unique. Durable et polyvalente, cette technologie absorbe la pression et la répartit sur la surface de la selle pour offrir le meilleur soutien, même pour vos plus longues sorties.

## Immediate Comfort



### SLOW FIT FOAM

Ideale per brevi spostamenti, Slow Fit Foam è una tecnologia esclusiva di Selle Royal progettata per adattarsi alla forma del tuo corpo. La sua formulazione in memory foam a lento effetto di ritorno fornisce comfort ottimale e assicura una sensazione di morbidezza durante la pedalata.

Idéale pour les sorties courtes et faciles, la mousse Slow Fit Foam est une technologie exclusive de Selle Royal conçue pour épouser la forme de votre corps. Sa formulation en mousse à mémoire de forme, avec un effet de rebondissement lent, procure un confort immédiat et assure une sensation de douceur pendant la conduite.

## Firm Comfort



### FOAM MATRIX

Robusta, flessibile e adatta alle uscite di tutti i giorni: un'imbottitura in Foam Matrix è la scelta ideale se sei alla ricerca di un supporto stabile e solido per i tuoi viaggi brevi e meno impegnativi.

Robuste, mais flexible pour les trajets quotidiens. Si vous recherchez un soutien ferme et solide pendant vos trajets courts et faciles, une selle avec un rembourrage Foam Matrix est ce qu'il vous faut.

## Extreme Durability



### UNITECH

Dotate di un unico materiale per imbottitura e rivestimento, le selle con tecnologia Unitech sono progettate per durare a lungo. Grazie a impermeabilità e alta resistenza all'abrasione, non dovrai più preoccuparti delle intemperie e delle sfide della giungla urbana.

Avec un rembourrage et un revêtement en une seule pièce, les selles dotées de la technologie Unitech sont conçues pour durer, car elles sont très résistantes à l'abrasion et imperméables. Vous n'aurez donc pas à vous soucier d'exposer votre selle aux éléments ou aux dangers de la ville.

## Waterproofness



### ROYAL VACUUM

Rimani all'asciutto durante le tue pedalate! Progettata per resistere all'acqua, questa tecnologia brevettata da Selle Royal permette alla sella di essere sigillata al 100% e quindi impermeabile, anche quando esposta a forti intemperie.

Profitez d'un trajet au sec avec une selle résistante à l'eau. Cette technologie brevetée Selle Royal permet à la selle d'être 100% étanche et substantiellement imperméable, même lorsqu'elle est exposée à un temps lourd et humide.

## Fresh Seat



### COOL COVER

Una speciale composizione del rivestimento della sella riflette la luce del sole ed assicura una temperatura di 25°C più fresca rispetto ad una sella nera standard. Potrai così lasciare la tua bici al sole senza pensarci due volte.

La composition spéciale de cette housse reflète la lumière du soleil et maintient votre selle à 25°C de moins qu'une selle noire standard. Vous pouvez donc laisser votre vélo au soleil sans y penser.

## Perineal Ventilation



### VENTILATION CHANNEL

Grazie a questa funzione di ventilazione non dovrai più temere il caldo durante i tuoi giri in bici: uno speciale canale anatomico consente all'aria di fluire attraverso la sella ed assicura una sensazione di freschezza mentre pedali, oltre ad una pressione ridotta nella zona perineale.

Ne laissez pas la surchauffe gâcher votre sortie : le canal de ventilation permet à l'air de circuler à travers votre selle grâce à une découpe anatomique, garantissant une sensation de brise et de non transpiration lorsque vous roulez. Conçu pour des sorties à la fraîche et réduire la pression dans la zone périnéale.

## Perineal Relief



### ERGONOMIC HOLE

Un foro centrale ergonomico progettato per alleviare la pressione nella zona perineale. Ideale anche per i ciclisti più sensibili: niente più fastidio durante le tue pedalate!

Une découpe centrale ergonomique conçue pour soulager la pression dans la zone périnéale, ce qui la rend idéale pour les cyclistes les plus sensibles. Pas de douleur, juste un avantage sur vos sorties!



### ERGONOMIC CHANNEL

Un canale progettato per seguire ergonomicamente la forma del corpo, offrendo sollievo dalla pressione nella zona perineale e supporto nella zona ischiatica. Niente più dolore durante le tue uscite in bicicletta!

Cette échancrure est conçue pour épouser de manière ergonomique la forme du corps, en apportant un soulagement de la pression dans les zones de tissus sensibles et un soutien dans la zone ischiatique. Pas de douleur, juste un avantage sur vos sorties!

## High Resistance



### STRENGTEX

Un rivestimento ultra resistente, progettato per aumentare la durata della sella. Grazie alla sua struttura multistrato, la tua sella ricoperta in Strengetex resiste a forature, tagli, strappi, crepe o invecchiamento. Perfetta per la giungla urbana.

Il s'agit d'un matériau de revêtement ultra-résistant conçu pour accompagner ce que subit toute selle au cours de sa vie. Grâce à sa structure multicouche, votre revêtement Strengetex ne craint pas les perforations, les coupures, les déchirures, les fissures ou le vieillissement et rend donc votre selle parfaite pour la jungle urbaine.

## Shock Absorption



### FLEXITE SYSTEM

Uno scafo con esclusiva costruzione dentellata, per una flessibilità ottimizzata e assorbimento degli urti. L'ideale per pedalare in città e per gite nella natura, senza rinunciare al massimo del comfort.

La construction unique de la coque assure une flexibilité et une absorption des chocs maximales, garantissant des sorties en douceur en ville ou dans la nature.



### THERMOPLASTIC DAMPER

Lavorando come un elastomero, questo ammortizzatore termoplastico posizionato nella parte posteriore della sella assorbe anche gli urti più forti ed assicura il massimo del comfort senza fare rumore.

Fonctionnant comme un élastomère, l'amortisseur thermoplastique placé à l'arrière de la selle adoucit les parcours cahoteux, en absorbant silencieusement les chocs les plus violents.



### ELASTOMERS

Pedala prestando sempre attenzione agli ostacoli improvvisi. Ma se ne manchi uno, la tua sella con elastomeri assorbirà anche gli urti più forti, senza fare rumore.

Vous faites toujours attention aux obstacles inattendus, mais si vous en manquez un, votre selle avec élastomères absorbera les chocs les plus sévères sans faire de bruit.



### CUPSPRINGS

Pedala prestando sempre attenzione agli ostacoli improvvisi. Ma se ne manchi uno, la tua sella con molle a tazza assorbirà anche gli urti più forti, senza fare rumore.

Vous faites toujours attention aux obstacles inattendus, mais si vous en manquez un, votre selle avec ressorts à coupelle absorbera les chocs les plus sévères sans faire de bruit.

## Safe Sides



### DOUBLE-COVER SIDE PROTECTION

Dimenticati dei lati della sella graffiati e appoggia la bici su qualsiasi superficie in totale libertà: il materiale a doppio strato applicato alle parti più esposte della sella aumenta la resistenza a urti e abrasioni.

Dites non aux flancs de selle éraflés et appuyez votre vélo contre n'importe quoi en toute liberté : le matériau double couche appliqué sur les flancs de la selle augmente la résistance aux impacts et aux abrasions.



### SCUFF GUARDS

Dimenticati dei lati della sella graffiati e appoggia la bici su qualsiasi superficie in totale libertà: gli inserti extra protettivi applicati ai lati della sella aumentano la resistenza a urti e abrasioni.

Dites adieu aux flancs de selle éraflés et appuyez votre vélo sur n'importe quoi en toute liberté : les inserts de protection supplémentaires appliqués sur les flancs de la selle augmentent la résistance aux impacts et aux abrasions.

## Safety at Night



### REFLECTIVE FILM

Essere visibili alle altre macchine mentre si pedala è di fondamentale importanza, negli spostamenti urbani tanto quanto nelle avventure fuoripista. Questa pellicola riflettente aumenta la tua visibilità: l'ideale in condizioni di scarsa luminosità o se la tua luce posteriore dovesse scaricarsi.

Que vous rouliez en ville ou que vous exploriez la nature, il est primordial de toujours être vu par les voitures, les vélos et les autres véhicules. Si, ou plutôt quand, votre feu arrière vous fait défaut, ce film réfléchissant protégera vos arrières pour une dose supplémentaire de sécurité.

## Spring Suspension



### DOUBLE SPRINGS

Le doppie molle garantiscono il massimo assorbimento degli urti e conferiscono alla sella un fascino classico. Per un look impeccabile senza rinunciare all'ammortizzazione che ti serve in città.

Un look saisissant et une excellente suspension, tout en un : les ressorts standard ont évolué pour améliorer les performances de la suspension tout en conservant leur allure classique, afin que vous n'ayez pas à faire de compromis sur le style - ou l'amortissement.



### SPRINGS

Garantendoti l'ammortizzazione che ti serve in città, le molle aggiungono un tocco classico alla tua bici.

Parfois, c'était mieux avant : les ressorts ajoutent une excellente suspension et une touche de classe à n'importe quel vélo.

## Clip & Go



### INTEGRATED CLIP SYSTEM

Studiato per i tuoi accessori Selle Royal, l'Integrated Clip System è posizionato nella parte posteriore della sella per facilitare l'aggancio di una borsetta o di altri accessori Selle Royal. Il tutto in un solo clip.

Un must pour vos accessoires Selle Royal : le système de clip intégré positionné à l'arrière de votre selle permet de fixer une sacoche de selle Selle Royal ou d'autres accessoires d'un simple clip.



### MULTI-TOOL

Niente più imprevisti durante le tue uscite in bici. Questo multi-tool si fissa alla clip posteriore della tua sella Selle Royal con Integrated Clip System, in modo da essere sempre a portata di mano per regolazioni e riparazioni mentre sei in giro. Protetto da una custodia in gomma antiurto, questo multi-tool compatto è composto da 9 attrezzi di qualità, per il massimo dell'affidabilità e della durevolezza.

Soyez toujours prêt à faire face aux imprévus. Ce multi-outil se fixe à l'arrière de votre selle Selle Royal équipée du système de clip intégré (ICS) afin d'être toujours à portée de main pour des réglages et des réparations rapides en cours de route. Protégé par un boîtier en caoutchouc antiflanc, cet ensemble compact et sécurisé offre 9 outils pour des années d'utilisation fiable.

## Support up to 150kg



### HEAVY-DUTY SUPPORT

Testata fino a 150 kg, una sella affidabile e durevole che non teme pesi elevati.

Testée jusqu'à 150 kg, une selle fiable et durable qui ne craint pas les poids lourds.

## E-Bike Specific



### E-FIT DESIGN

Un design innovativo dalla forma curva ti aiuta a trovare facilmente la posizione corretta sulla tua e-bike. Allo stesso tempo la sezione posteriore rialzata della sella previene lo scivolamento all'indietro e garantisce il massimo comfort per la tua schiena. Infine, i lati della sella sono flessibili in modo da migliorare la stabilità e facilitare la pedalata.

Un design innovant en forme de vague pour vous aider à trouver immédiatement la bonne position sur votre VAE. Sa section arrière surélevée vous empêchera de glisser vers l'arrière pour assurer un confort maximal à votre dos, tandis que les côtés de la selle, d'une flexibilité unique, ajoutent de la stabilité et facilitent le pédalage.

## Easy Handling



### E-GRIP

Una maniglia gommata "soft-touch" integrata nella parte posteriore della sella facilita la manovrabilità della tua e-bike.

Tenez bien en main votre vélo électrique grâce à cette fonctionnalité intelligente : une poignée intégrée et douce au toucher qui facilite les manœuvres.

## Sustainable Choice



### ECO APPROACH

Selle Royal rafforza il suo impegno per ridurre l'impatto ambientale dei suoi prodotti. La base di questa sella è realizzata al 100% con plastica riciclata, pur mantenendo lo stesso livello di flessibilità e comfort. Il rivestimento di origine biologica è composto per il 50% da materiali organici, garantendo la stessa elasticità, resistenza all'abrasione e livello di comfort pur utilizzando solo plastificanti naturali.

Selle Royal renforce son engagement à réduire l'impact environnemental de ses produits. La base de cette selle est fabriquée à partir de plastique 100% recyclé, tout en conservant le même niveau de flexibilité et de confort. Le revêtement BIO-sourcé est composé de 50% de matériaux organiques, garantissant le même niveau d'élasticité, de résistance à l'abrasion et de confort tout en utilisant uniquement des plastifiants naturels.



All Journeys  
Riding Everywhere





**ON Athletic**  
Unisex

-  E-Fit Design
-  Royalgel™
-  E-Grip
-  Royal Vacuum
-  Integrated Clip System



**ON Moderate**  
Unisex

-  E-Fit Design
-  Royalgel™
-  E-Grip
-  Royal Vacuum
-  Integrated Clip System



**ON Relaxed**  
Unisex

-  E-Fit Design
-  Royalgel™
-  E-Grip
-  Royal Vacuum
-  Integrated Clip System



ARTICLE	EAN	NAME	RIDING POSITION	GENDER	SIZES	PRICE (€)
94C7UROA05X37	8021890570239	<b>On</b>	Athletic	Unisex	L 281mm / W 157mm / W 465g	89,90
94C8DROA05X37	8021890570260	<b>On</b>	Moderate	Unisex	L 268mm / W 190mm/ W 531g	89,90
94C9UROA05X37	8021890570291	<b>On</b>	Relaxed	Unisex	L 269mm / W 224mm / W 642g	89,90

**NEW**



**ON OPEN Athletic Unisex**

-  Royal Vacuum
-  E-Fit Design
-  E-Grip
-  Royalgel™
-  Ergonomic Hole
-  Integrated Clip System



**NEW**



**ON OPEN Moderate Unisex**

-  Royal Vacuum
-  E-Fit Design
-  E-Grip
-  Royalgel™
-  Ergonomic Hole
-  Integrated Clip System



**NEW**



**ON OPEN Relaxed Unisex**

-  Royal Vacuum
-  E-Fit Design
-  E-Grip
-  Royalgel™
-  Ergonomic Hole
-  Integrated Clip System



ARTICLE	EAN	NEW	NAME	RIDING POSITION	GENDER	SIZES	PRICE (€)
94F6UROA05X37	8021890592477	<b>NEW</b>	<b>On Open</b>	Athletic	Unisex	L 281mm / W 158mm / W 443g	89,90
94F7DROA05X37	8021890592491	<b>NEW</b>	<b>On Open</b>	Moderate	Unisex	L 269mm / W 190mm / W 499g	89,90
94F8UROA05X37	8021890592514	<b>NEW</b>	<b>On Open</b>	Relaxed	Unisex	L 270mm / W 224mm / W 629g	89,90

### Royalgel™

Superiore a qualsiasi altra imbottitura grazie alla sua formulazione unica, Royalgel™ è studiato per garantire il massimo livello di comfort. Durevole e versatile, questa tecnologia assorbe la pressione e la distribuisce su tutta la superficie della sella, garantendo un supporto ottimale anche nelle pedalate più lunghe.

Supérieur à tout autre matériau de rembourrage, le Royalgel™ offre le plus haut niveau de confort grâce à sa formulation unique. Durable et polyvalente, cette technologie absorbe la pression et la répartit sur la surface de la selle pour offrir le meilleur soutien, même pour vos plus longues sorties.



### Royal Vacuum

Rimani all'asciutto durante le tue pedalate! Progettata per resistere all'acqua, questa tecnologia brevettata da Selle Royal permette alla sella di essere sigillata al 100% e quindi impermeabile, anche quando esposta a forti intemperie.

Profitez d'un trajet au sec avec une selle résistante à l'eau. Cette technologie brevetée Selle Royal permet à la selle d'être 100% étanche et substantiellement imperméable, même lorsqu'elle est exposée à un temps lourd et humide.

### e-Fit Design

Un design innovativo dalla forma curva ti aiuta a trovare facilmente la posizione corretta sulla tua e-bike. Allo stesso tempo la sezione posteriore rialzata della sella previene lo scivolamento all'indietro e garantisce il massimo comfort per la tua schiena. Infine, i lati della sella sono flessibili in modo da migliorare la stabilità e facilitare la pedalata.

Un design innovant en forme de vague pour vous aider à trouver immédiatement la bonne position sur votre VAE. Sa section arrière surélevée vous empêchera de glisser vers l'arrière pour assurer un confort maximal à votre dos, tandis que les côtés de la selle, d'une flexibilité unique, ajoutent de la stabilité et facilitent le pédalage.



### Integrated Clip System

Studiato per i tuoi accessori Selle Royal, l'Integrated Clip System è posizionato nella parte posteriore della sella per facilitare l'aggancio di una borsetta o di altri accessori Selle Royal. Il tutto in un solo clip.

Un must pour vos accessoires Selle Royal : le système de clip intégré positionné à l'arrière de votre selle permet de fixer une sacoche de selle Selle Royal ou d'autres accessoires d'un simple clip.

### Ergonomic Hole

Un foro centrale ergonomico progettato per alleviare la pressione nella zona perineale. Ideale anche per i ciclisti più sensibili: niente più fastidio durante le tue pedalate!

Une découpe centrale ergonomique conçue pour soulager la pression dans la zone périnéale, ce qui la rend idéale pour les cyclistes les plus sensibles. Pas de douleur, juste un avantage sur vos sorties !



### e-Grip

Una maniglia gommata "soft-touch" integrata nella parte posteriore della sella facilita la manovrabilità della tua e-bike.

Tenez bien en main votre vélo électrique grâce à cette fonctionnalité intelligente : une poignée intégrée et douce au toucher qui facilite les manœuvres.



**RESPIRO Athletic**  
Unisex

- Royalgel™
- Ventilation Channel
- Cool Cover
- Scuff Guards
- Royal Vacuum
- Integrated Clip System



**RESPIRO Moderate**  
Unisex

- Royalgel™
- Ventilation Channel
- Cool Cover
- Scuff Guards
- Elastomers
- Royal Vacuum
- Integrated Clip System



**RESPIRO Relaxed**  
Unisex

- Royalgel™
- Ventilation Channel
- Cool Cover
- Scuff Guards
- Elastomers
- Royal Vacuum
- Integrated Clip System



ARTICLE	EAN	NAME	RIDING POSITION	GENDER	SIZES	PRICE (€)
5130HRTB691L4	8021890575098	<b>Respiro</b>	Athletic	Unisex	L 279mm / W 159mm / W 429g	79,90
5131HETB291L4	8021890578969	<b>Respiro</b>	Moderate	Unisex	L 277mm / W 182mm / W 535g	79,90
5132DETB291L4	8021890575104	<b>Respiro</b>	Relaxed	Unisex	L 256mm / W 227mm / W 771g	79,90



**LOOKIN Athletic**  
Unisex

-  Royalgel™
-  Cool Cover
-  Scuff Guards
-  Royal Vacuum
-  Integrated Clip System



**LOOKIN Moderate**  
Unisex

-  Royalgel™
-  Cool Cover
-  Scuff Guards
-  Elastomers
-  Royal Vacuum
-  Integrated Clip System



**LOOKIN Relaxed**  
Unisex

-  Royalgel™
-  Cool Cover
-  Scuff Guards
-  Elastomers
-  Royal Vacuum
-  Integrated Clip System



ARTICLE	EAN	NAME	RIDING POSITION	GENDER	SIZES	PRICE (€)
5234HR3A39188	8021890575135	<b>Lookin</b>	Athletic	Unisex	L 279mm / W 160mm / W 440g	69,90
5235DE3A39188	8021890578990	<b>Lookin</b>	Moderate	Unisex	L 269mm / W 198mm / W 620g	69,90
5236DE3A59188	8021890575142	<b>Lookin</b>	Relaxed	Unisex	L 260mm / W 228mm / W 830g	69,90





**LOOKIN Evo Athletic**  
Unisex

-  Eco Approach
-  Royalgel™
-  Flexyte System
-  Royal Vacuum
-  Integrated Clip System



**LOOKIN Evo Moderate**  
Unisex

-  Eco Approach
-  Royalgel™
-  Flexyte System
-  Royal Vacuum
-  Integrated Clip System



**LOOKIN Evo Relaxed**  
Unisex

-  Eco Approach
-  Royalgel™
-  Flexyte System
-  Cupsprings
-  Royal Vacuum
-  Integrated Clip System



ARTICLE	EAN	NAME	RIDING POSITION	GENDER	SIZES	PRICE (€)
52E2UROA0B004	8021890579027	<b>Lookin Evo</b>	Athletic	Unisex	L 261mm / W 158mm / W 448g	74,90
52E3HROA0B004	8021890579034	<b>Lookin Evo</b>	Moderate	Unisex	L 271mm / W 186mm / W 500g	74,90
52E4UEOA0B004	8021890579041	<b>Lookin Evo</b>	Relaxed	Unisex	L 248mm / W 223mm / W 682g	74,90

# WE STARTED FROM THE

# BOTTOM



## Lookin Evo

100% recycled plastic base + 50% BIO-sourced cover =  
-24% CO<sub>2</sub> emissions



# Adventure Time Exploring Outdoors





**VAIA Athletic**  
Unisex

- Royalgel™
- Ergonomic Hole
- Royal Vacuum
- Integrated Clip System
- Multi-Tool



**VAIA Moderate**  
Unisex

- Royalgel™
- Ergonomic Hole
- Royal Vacuum
- Integrated Clip System
- Multi-Tool



**VAIA Relaxed**  
Unisex

- Royalgel™
- Ergonomic Hole
- Thermoplastic Damper
- Royal Vacuum
- Integrated Clip System



ARTICLE	EAN	NAME	RIDING POSITION	GENDER	SIZES	PRICE (€)
84E5UROA05X38	8021890593504	<b>Vaia</b>	Athletic	Unisex	L 271mm / W 151mm / W 382g	69,90
84E6HROA05X38	8021890593511	<b>Vaia</b>	Moderate	Unisex	L 270mm / W 167mm / W 406g	69,90
84E7UEOA05X38	8021890593528	<b>Vaia</b>	Relaxed	Unisex	L 250mm / W 213mm / W 580g	69,90



### Multi-Tool Integrated

Questo multitool si aggancia al retro di ogni sella Selle Royal grazie all'Integrated Clip System (ICS). Incluso nelle selle Athletic e Moderate Vaia, è l'ideale per essere sempre a portata di mano per regolazioni e facili riparazioni in viaggio. Protetto da un custodia in gomma antiurto, questo multitool compatto e sicuro include 9 attrezzi affidabili e durevoli nel tempo.

Ce multi-outil se fixe à l'arrière de n'importe quelle selle Selle Royal grâce au système de clip intégré (ICS). Il est déjà inclus dans les selles Athletic et Moderate Vaia afin d'être toujours à portée de main pour des réglages et des réparations rapides sur la route. Protégé par un boîtier en caoutchouc antichoc, cet ensemble compact et sûr offre 9 outils pour des années d'utilisation fiable.

### Water Resistant

Royal Vacuum Light è una tecnologia Selle Royal brevettata che consente al rivestimento di essere al 100% sigillato e per questo resistente all'acqua. Inoltre, questo rende la sella il 20% più leggera!

Royal Vacuum Light est une technologie brevetée Selle Royal qui permet à la selle d'être 100% étanche et donc résistante à l'eau. De plus, cela la rend 20% plus légère!



### Ergonomic Hole

Un foro centrale ergonomico progettato per alleviare la pressione nella zona perineale, ideale per chi è più sensibile. Questa sella con foro ergonomico segue la forma del corpo, offrendo massimo sollievo dalla pressione nella zona perineale e sostegno nella zona ischiatica.

Une découpe centrale ergonomique conçue pour soulager la pression dans la zone périnéale, ce qui la rend idéale pour les cyclistes les plus sensibles. Cette selle à découpe ergonomique épouse la forme du corps, offrant un soulagement supérieur de la pression dans la zone périnéale et un soutien dans la zone ischiatique.

### Royalgel™

Grazie alla sua speciale struttura tridimensionale, Royalgel™ garantisce il più alto livello di comfort, riducendo i picchi di pressione del 40% rispetto alle normali imbottiture.

Grâce à sa structure tridimensionnelle unique en gel, Royalgel™ garantit le plus haut niveau de confort, réduisant ainsi les pics de pression de 40% par rapport aux matériaux de rembourrage habituels.

### Thermoplastic Damper

(solo in posizione di marcia a 90°)  
(Uniquement en position de pédalage 90°)

Lavorando come un elastomero, questo ammortizzatore indeformabile fisso posto nella parte posteriore assorbe anche gli shock più severi e inaspettati, per garantire una performance sicura, silenziosa e confortevole.

Fonctionnant comme un élastomère, ce mono amortisseur absolument indéformable, positionné à l'arrière de la selle, absorbe même les chocs les plus violents et inattendus procurant sécurité, silence et confort.



### Integrated Clip System

Sistema a clip brevettato posto nel retro della sella, per un'installazione facile delle borsette sottosella Selle Royal o di altri accessori.

Un système de clip breveté positionné à l'arrière de la selle permet de fixer facilement une sacoche de selle Selle Royal ou tout autre accessoire.



 selle royal

Selle Royal



**EXPLORA Athletic**  
Unisex



Royalgel™



Ergonomic Channel



Royal Vacuum



Integrated Clip System



**EXPLORA Moderate**  
Unisex



Royalgel™



Ergonomic Channel



Royal Vacuum



Integrated Clip System



**EXPLORA Relaxed**  
Unisex



Royalgel™



Ergonomic Channel



Thermoplastic Damper



Royal Vacuum



Integrated Clip System



ARTICLE	EAN	NAME	RIDING POSITION	GENDER	SIZES	PRICE (€)
54D1UR0A05X38	8021890569721	<b>Explora</b>	Athletic	Unisex	L 274mm / W 152mm / W 379g	69,90
54D2HROA05X38	8021890569745	<b>Explora</b>	Moderate	Unisex	L 273mm / W 171mm / W 415g	69,90
54D3UE0A05X38	8021890569769	<b>Explora</b>	Relaxed	Unisex	L 253mm / W 218mm / W 598g	69,90











# Urban Life Moving in the City





**ELLIPSE Athletic**  
Unisex

-  Royalgel™
-  Ergonomic Hole
-  Double-Cover Side Protection
-  Royal Vacuum
-  Integrated Clip System



**ELLIPSE Moderate**  
Unisex

-  Royalgel™
-  Ergonomic Hole
-  Double-Cover Side Protection
-  Elastomers
-  Royal Vacuum
-  Integrated Clip System



**ELLIPSE Relaxed**  
Unisex

-  Royalgel™
-  Ergonomic Hole
-  Double-Cover Side Protection
-  Elastomers
-  Royal Vacuum
-  Integrated Clip System



ARTICLE	EAN	NAME	RIDING POSITION	GENDER	SIZES	PRICE (€)
81B5UR0A09320	8021890593474	<b>Ellipse</b>	Athletic	Unisex	L 265mm / W 163mm / W 406g	54,90
81B6HE0A09321	8021890593481	<b>Ellipse</b>	Moderate	Unisex	L 276mm / W 180mm / W 474g	54,90
81B7UE0A09321	8021890593498	<b>Ellipse</b>	Relaxed	Unisex	L 250mm / W 223mm / W 638g	54,90



### FREEWAY FIT Athletic Unisex



Slow Fit  
Foam



Royal  
Vacuum



Integrated  
Clip System



### FREEWAY FIT Moderate Unisex



Slow Fit  
Foam



Scuff  
Guards



Royal  
Vacuum



Integrated  
Clip System



### FREEWAY FIT Relaxed Unisex



Slow Fit  
Foam



Scuff  
Guards



Royal  
Vacuum



Integrated  
Clip System



ARTICLE	EAN	NAME	RIDING POSITION	GENDER	SIZES	PRICE (€)
8V99UROA38069	8021890575623	<b>Freeway Fit</b>	Athletic	Unisex	L 280mm / W 158mm / W 435g	44,90
8V97DROA38069	8021890578891	<b>Freeway Fit</b>	Moderate	Unisex	L 260mm / W 188mm / W 520g	44,90
8V98UROA38069	8021890575616	<b>Freeway Fit</b>	Relaxed	Unisex	L 257mm / W 210mm / W 550g	44,90



**FLOAT Athletic Unisex**

-  Slow Fit Foam
-  Ergonomic Hole
-  Royal Vacuum
-  Integrated Clip System



**FLOAT Moderate Unisex**

-  Slow Fit Foam
-  Ergonomic Hole
-  Elastomers
-  Royal Vacuum
-  Integrated Clip System



**FLOAT Relaxed Unisex**

-  Slow Fit Foam
-  Ergonomic Hole
-  Elastomers
-  Royal Vacuum
-  Integrated Clip System



ARTICLE	EAN	NAME	RIDING POSITION	GENDER	SIZES	PRICE (€)
8VC1UR0A38V14	8021890575593	<b>Float</b>	Athletic	Unisex	L 267mm / W 161mm / W 382g	44,90
8VC2DE0A38V14	8021890579003	<b>Float</b>	Moderate	Unisex	L 263mm / W 200mm / W 547g	44,90
8VC3UE0A38V14	8021890575609	<b>Float</b>	Relaxed	Unisex	L 251mm / W 228mm / W 628g	44,90



**AVENUE Athletic**  
Unisex



Royalgel™



Ergonomic Channel



Royal Vacuum



**AVENUE Moderate**  
Unisex



Royalgel™



Ergonomic Channel



Elastomers



Royal Vacuum



Integrated Clip System



**AVENUE Relaxed**  
Unisex



Royalgel™



Ergonomic Channel



Elastomers



Royal Vacuum



Integrated Clip System



ARTICLE	EAN	NAME	RIDING POSITION	GENDER	SIZES	PRICE (€)
8468HGOA28096	8021890575661	<b>Avenue</b>	Athletic	Unisex	L 265mm / W 158mm / W 462g	39,90
8466DGOA28096	8021890578907	<b>Avenue</b>	Moderate	Unisex	L 258mm / W 183mm / W 664g	39,90
8493DGOA28096	8021890575678	<b>Avenue</b>	Relaxed	Unisex	L 267mm / W 218mm / W 730g	39,90



**VIVO Athletic**  
Unisex



Foam Matrix



Reflective Film



Ergonomic Channel



**DRIFTER STRENGTEX**  
Relaxed / Unisex



Royalgel™



Strengetex



Double Springs



Royal Vacuum



**DRIFTER PLUS Relaxed**  
Unisex



Royalgel™



Double Springs



Royal Vacuum



ARTICLE	EAN	NAME	RIDING POSITION	GENDER	SIZES	PRICE (€)
1217DRNA37823	6957312803093	<b>Vivo</b>	Athletic	Unisex	L 249mm / W 160mm / 375g	29,90
5111UDTC95301	8021890575371	<b>Drifter Strengetex</b>	Relaxed	Unisex	L 270mm / W 245mm / W 1160g	54,90
5111UDTD08129	8021890575388	<b>Drifter Plus</b>	Relaxed	Unisex	L 270mm / W 245mm / W 1173g	54,90



**ONDINA Relaxed Unisex**



Royalgel™



Springs



Royal Vacuum



Integrated Clip System



**HOLLAND Relaxed Unisex**



Royalgel™



Springs



Royal Vacuum



Integrated Clip System



**WITCH Relaxed Unisex**



Foam Matrix



Springs



Royal Vacuum



ARTICLE	EAN	NAME	RIDING POSITION	GENDER	SIZES	PRICE (€)
8171US0A98129	8021890575630	<b>Ondina</b>	Relaxed	Unisex	L 253mm / W 214mm / W 690g	34,90
82615G2A18132	8021890575654	<b>Holland</b>	Relaxed	Unisex	L 247mm / W 219mm / W 690g	29,90
8013USTA18096	8021890581570	<b>Witch</b>	Relaxed	Unisex	L 260mm / W 243mm / W 651g	19,90





Kids saddles



# Kids Saddles

## FROGGY

Consigliata per bici da bambini da 12"-14"-16"  
Recommandées pour vélos enfants 12"-14"-16"



boy & girl

## CANDY

Consigliata per bici da bambine da 16"-20"-24"  
Recommandées pour vélos fillettes 16" - 20" - 24"



girl

## BEN

Consigliata per bici da bambini da 16"-20"-24"  
Recommandées pour vélos enfants 16"-20"-24"

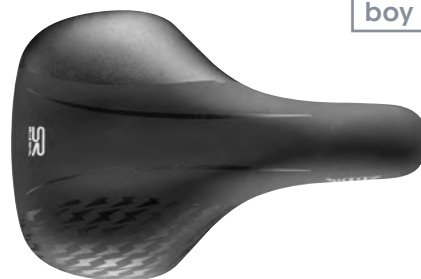

boy

## HELLO

Consigliata per bici junior da 24"  
Recommandées pour vélo junior 24"

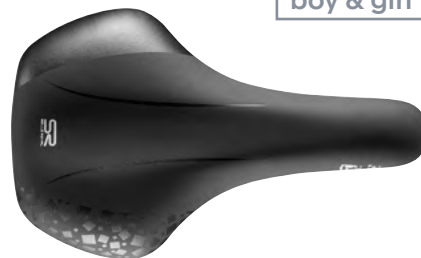

boy & girl

ARTICLE	EAN	NAME	RIDING POSITION	GENDER	SIZES	PRICE (€)
1702JCNA03807	6957312801310	<b>Froggy</b>	Kids 12"-16"	Boy & Girl	L 202mm / W 150mm / W 287g	19,90
1703DRNA03807	6957312801327	<b>Candy</b>	Kids 16"-24"	Girl	L 230mm / W 172mm / W 320g	19,90
1703HRNA03807	6957312801334	<b>Ben</b>	Kids 16"-24"	Boy	L 230mm / W 151mm / W 290g	19,90
1704JRNA03807	6957312801341	<b>Hello</b>	Junior 24"	Boy & Girl	L 250mm / W 151mm / W 325g	19,90

# Saddle bags

## Saddle Bag Medium - 1,2 l

Compatibile con Integrated Clip System, brugola inclusa, sistema di fissaggio esterno per luce.

Système de clip intégré compatible, clé allen incluse, clip d'éclairage externe.



## Saddle Bag Large - 2,0 l

Compatibile con Integrated Clip System, brugola inclusa, impermeabile, sistema di fissaggio esterno per luce.

Compatible avec le système de clip intégré, clé allen incluse, étanche, clip d'éclairage externe.



## Saddle Bag Extra Large - 7,0 l

Compatibile con Integrated Clip System, brugola inclusa, impermeabile, sistema di fissaggio esterno per luce, tracolla inclusa.

Système de clip intégré compatible, clé allen incluse, étanche, clip d'éclairage externe, bandoulière incluse.



ARTICLE	EAN	NAME	COVER	SIZES	PRICE (€)
BAGS300A00000	8021890494955	<b>Saddle Bag Medium 1,2l</b>	Polyester, PVC	L 210mm / W 95mm / H 115mm	19,90
BAGS400A00000	8021890494979	<b>Saddle Bag Large 2,0l</b>	Water resistant Polyester, PVC	L 330mm / W 190mm / H 95mm	24,90
BAGS500A00000	8021890574916	<b>Saddle Bag Extra Large 7,0l</b>	Water resistant Polyester, PVC	L 618mm / W 236mm / H 175mm	59,90

## Seat Covers

### Royalgel™ Seat Cover Small & Large - Unisex

Rientranza anatomica | Royalgel™ visibile  
Empreinte anatomique | Royalgel™ visible



### Slow Fit Foam Seat Cover Small & Large - Unisex

Rientranza anatomica | Slow Fit Foam  
Empreinte anatomique | Slow Fit Foam



ARTICLE	EAN	NAME	COLOR	SIZES	PRICE (€)
SCVM300A05800	6957312803116	<b>Royalgel™ Seat Cover Small</b>	Black/Orange	L 270mm / W 190mm / W 244g	19,90
SCVL300A05800	6957312803147	<b>Royalgel™ Seat Cover Large</b>	Black/Orange	L 248mm / W 221mm / W 254g	19,90
SCMM100A75800	6957312803109	<b>Slow Fit Foam Seat Cover Small</b>	Black	L 273mm / W 185mm / W 160g	19,90
SCML100A75800	6957312803130	<b>Slow Fit Foam Seat Cover Large</b>	Black	L 251mm / W 220mm / W 168g	19,90

# Accessories

**Packable Rain Cover  
Dispenser**



**Clamp  
Black / Silver**



ARTICLE	EAN	NAME	COLOR	SIZES/QUANTITY	PRICE (€)
SRSC000A00000	8021890574077	<b>Packable rain cover dispenser</b>	Black	L 107mm / W 120mm / H 258mm	11,90
V006000C00000	8021890472533	<b>Clamp</b>	Black	3 Components (single packaging)	3,00
V006000B90000	8021890472526	<b>Clamp</b>	Silver	3 Components (single packaging)	2,50
V006000C10000	8021890472540	<b>Clamp</b>	Silver	5 Components 38 D. (single packaging)	2,50
V006000B70000	8021890324665	<b>Clamp</b>	Black	3 Components + Locknut	2,00
V006000B60000	8021890324658	<b>Clamp</b>	Silver	3 Components + Locknut	2,00
V006000B80000	8021890324672	<b>Clamp</b>	Silver	5 Components 38 D.	2,00

## Spare parts

Gli Original Spare Parts by Selle Royal sono selle adibite al ricambio e vengono fornite in masterbox dedicati. Sono provviste di un apposito bindello descrittivo invece dell'appendisella.

Les "Original Spare Parts by Selle Royal" sont des pièces de rechange d'origine fournies en cartons contenant un nombre de pièces déterminé. Elles sont pourvues d'une notice explicative au lieu d'un "hang tag".



**Mach Box Athletic**  
Unisex / 28 pcs



**Lancia Box Athletic**  
Unisex / 20 pcs



**Avenue Box Athletic**  
Unisex / 24 pcs



**Moody Box Moderate**  
Woman / 18 pcs



**Rio Unitech Moderate**  
Unisex / 15 pcs



**Holland Unitech Relaxed**  
Unisex / 10 pcs



ARTICLE	EAN	NAME	RIDING POSITION	GENDER	QUANTITY/BOX
SRTC000C70000	8021890459428	<b>Mach Box</b>	Athletic	Unisex	28 pcs
SRTC000C80000	8021890459435	<b>Lancia Box</b>	Athletic	Unisex	20 pcs
SRTC000C90000	8021890459442	<b>Avenue Box</b>	Athletic	Unisex	24 pcs
8072DROA18067	8021890443656	<b>Moody Box</b>	Moderate	Woman	18 pcs
302ODRMA12010	8021890498564	<b>Rio Unitech</b>	Moderate	Unisex	15 pcs
3061USOA12010	8021890485816	<b>Holland Unitech</b>	Relaxed	Unisex	10 pcs

# SELLE ROYAL SCIENTIA FOR CYCLISTS

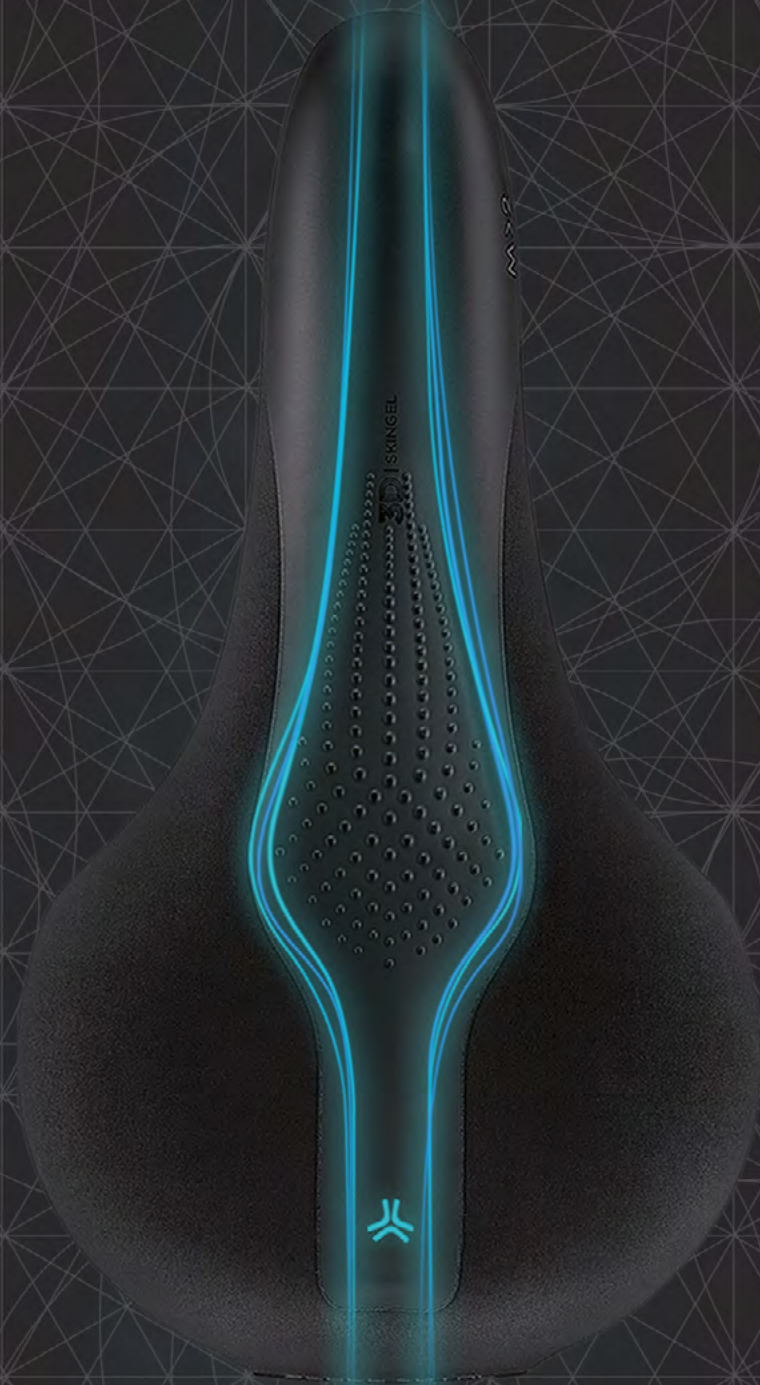

Scientifically developed in collaboration with



Deutsche  
Sporthochschule Köln  
German Sport University Cologne

Product range



ARTICLE	EAN	NAME	RIDING POSITION	ISCHIAL VARIATION	GENDER	SIZES	PRICE (€)
54AOSBOA09210	8021890427045	<b>Scientia A1</b>	Athletic	Small	Unisex	L 289mm / W 127mm / W 380g	89,90
54AOMBOA09210	8021890427038	<b>Scientia A2</b>	Athletic	Medium	Unisex	L 289mm / W 144mm / W 390g	89,90
54AOLBOA09210	8021890427021	<b>Scientia A3</b>	Athletic	Large	Unisex	L 289mm / W 159mm / W 415g	89,90
54MOSBOA09210	8021890427076	<b>Scientia M1</b>	Moderate	Small	Unisex	L 289mm / W 141mm / W 425g	89,90
54MOMBOA09210	8021890427069	<b>Scientia M2</b>	Moderate	Medium	Unisex	L 289mm / W 161mm / W 455g	89,90
54MOLBOA09210	8021890427052	<b>Scientia M3</b>	Moderate	Large	Unisex	L 289mm / W 178mm / W 465g	89,90
54ROSBOA09210	8021890427106	<b>Scientia R1</b>	Relaxed	Small	Unisex	L 289mm / W 169mm / W 479g	89,90
54ROMBOA09210	8021890427090	<b>Scientia R2</b>	Relaxed	Medium	Unisex	L 289mm / W 196mm / W 485g	89,90
54ROLBOA09210	8021890427083	<b>Scientia R3</b>	Relaxed	Large	Unisex	L 289mm / W 224mm / W 520g	89,90



# Scientia features



## Body contour | Contour du corps

Design dei bordi con raggio specifico per fornire un comfort ottimale per le diverse inclinazioni del ciclista. Maggiore è l'inclinazione della posizione di guida, minore è il raggio dei bordi.

Un profil conçu par rapport au rayon, optimisant le confort du cycliste en fonction de l'inclinaison de sa colonne vertébrale. Plus la position est inclinée, plus petit est le rayon.



## Rear plateau | Plateau arrière

Una parte posteriore rialzata impedisce di arretrare con la posizione in sella e riduce la pressione al centro, in corrispondenza della zona perineale, garantendo così il comfort desiderato.

La partie arrière de la coque est surélevée afin d'éviter le glissement vers l'arrière de l'utilisateur et diminuer ainsi la pression sur le milieu de la selle, soulageant la zone périnéale et améliorant ainsi le confort.



## Central reservoir | Canal central

Canale centrale scavato: forma e dimensioni sono stati studiati per corrispondere alla distanza delle ossa ischiatiche per garantire un maggiore comfort.

La partie centrale de la selle présente un creu correspondant à la forme et à l'espace entre les ischions afin de garantir le meilleur confort.

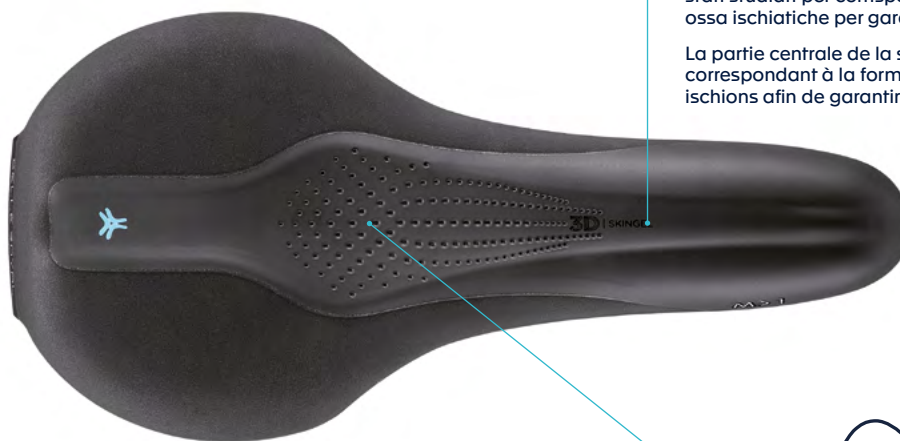

## Curva suspension | Systeme d'amortissement curva

Questo esclusivo sistema di sospensione è fissato alla parte posteriore dello scafo, per offrire un comfort esclusivo evitando la pressione sui punti di contatto delle ossa ischiatiche, garantendo così una maggiore flessibilità laterale.

Ce système d'amortissement unique, est fixé sur la partie arrière de la coque. Il procure un niveau de confort optimal en éliminant la pression due au contact des ischions sur la coque, garantissant une flexibilité latérale plus importante.



## 3D Skingel

Royalgel™ è sapientemente posizionato in corrispondenza dei punti di contatto critici della superficie della sella, ovvero la zona di contatto dei tessuti molli, per un maggiore assorbimento degli urti.

Le Royalgel™ est positionné au niveau des divers emplacements critiques qui correspondent aux points de contact avec les tissus mous, dans le but d'absorber le moindre choc.



# Measurement steps

## 1 Trova la tua posizione di guida Sélectionner la position de pedalage souhaitée

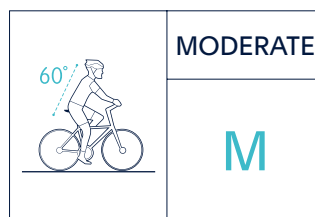

## 2 Determina la distanza tra le ossa ischiatiche Déterminer la largeur entre les ischions

Ripristinare lo stato di partenza del cuscinetto gel.

Réinitialisation du coussin gel.

Sedersi a 90° e tirare le impugnature laterali per esercitare pressione sulla superficie dello sgabello.

S'asseoir à 90 degrés et tirer sur les poignées afin d'augmenter la pression sur le tabouret.

Individuare i centri delle due impronte delle ossa ischiatiche e aggiungere i due numeri.

Trouver le centre de l'empreinte de chaque os d'assise sur le tabouret et ajouter les deux chiffres correspondants.

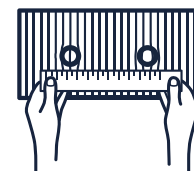
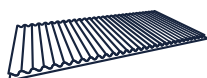

Esempio/Exemple:  
5cm + 7cm = 12cm





“Supporting Cyclists” è sempre stata la mission di Selle Royal: da più di 60 anni supportiamo i ciclisti, offrendo selle e accessori di alta qualità per godere al meglio delle proprie pedalate. Ma ci piacerebbe fare di più. Per questo abbiamo trovato un modo per rendere la tua esperienza in bici ancora più piacevole.

### **Have a coffee while we check your bike!**

Il Van di Selle Royal attraverserà l'Europa per incontrare i ciclisti e ascoltare le loro storie, con un simpatico team a bordo che offrirà caffè gratuito, un controllo della bici e un sorriso! Non importa che tipo di ciclista sei, tutti sono invitati a far parte di questa esperienza.

Segui le avventure del Van così potrai sapere dove trovarci e raggiungerci!

Soutenir les cyclistes a toujours été la mission de Selle Royal. Depuis plus de 60 ans, nous offrons aux cyclistes la meilleure conduite possible avec des selles et des accessoires abordables et de haute qualité. Mais pour nous, cela ne suffit pas. Nous avons donc trouvé une nouvelle façon de rendre votre expérience à vélo encore plus agréable.

### **Have a coffee while we check your bike!**

Le Selle Royal Van voyage à travers l'Europe pour aller à la rencontre des cyclistes, écouter leurs histoires, offrir des cafés et des bilans techniques, le tout avec le sourire de notre équipe dédiée. Tous les cyclistes sont invités à faire partie de cette expérience, peu importe leur monture et leur manière de rouler.

Rejoignez-nous simplement en suivant les aventures du van. Vous saurez alors où nous trouver.



Selle Royal

SR

Have a coffee  
while we check  
your bike!

Selle Royal

follow the van adventures on

[www.selleroyal.com](http://www.selleroyal.com)



ZB  
990 AE



RECOVERY zone  
with memory foam

SUPPORT zone

r.e.med

ACTIVE zone

RECOVERY zone  
with memory foam

SUPPORT zone

r.e.med

ACTIVE zone



L6

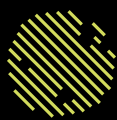

r.e.med

## The ergonomic approach

Le selle **R.e.Med** sono state progettate per permettere al corpo di distribuire naturalmente lo stress in 3 zone della sella: **AZIONE**, **RECUPERO** e **SUPPORTO**, donando in questo modo sollievo e comfort, mantenendo una pressione inalterata se si cambia posizione tra il fronte ed il retro della sella.

Les selles **R.e.Med** ont été conçues pour permettre au corps de distribuer naturellement le stress sur 3 zones de la selle: **ACTION**, **RECUPERATION** et **SUPPORT**, procurant ainsi soulagement et confort même en maintenant une pression constante s'il l'on change de position par rapport au bec et à l'arrière de la selle.

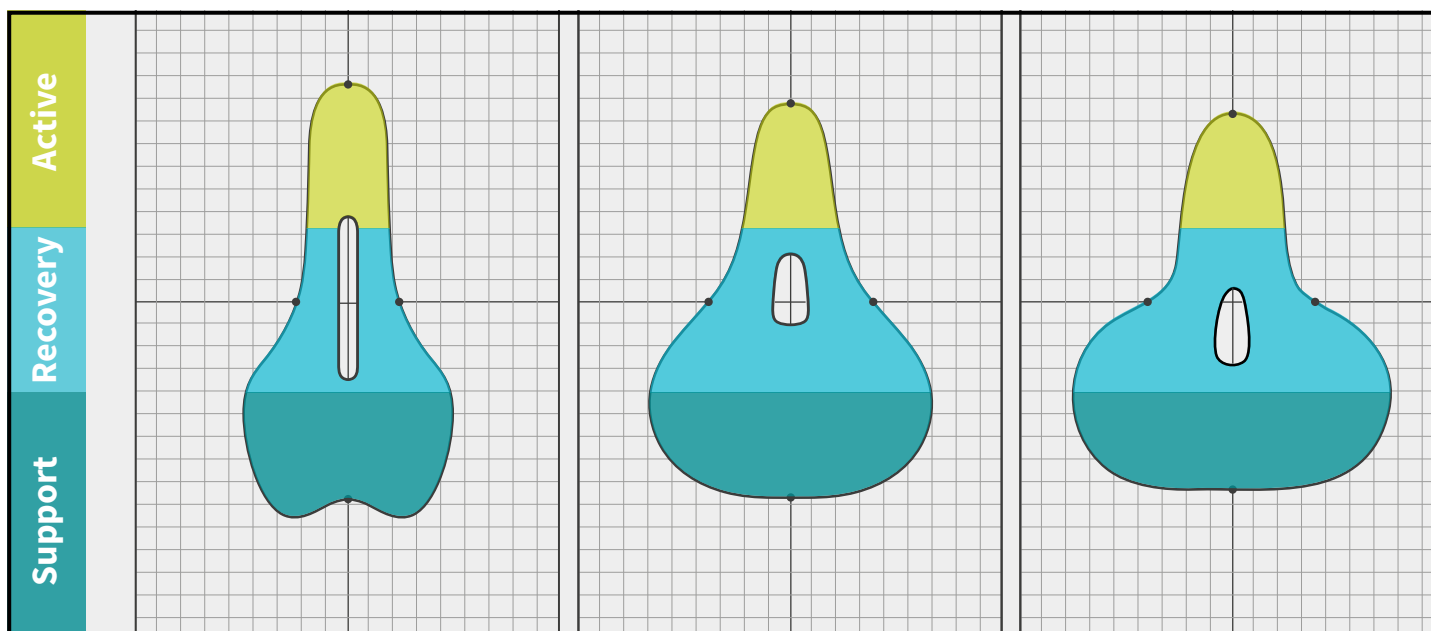

## The features

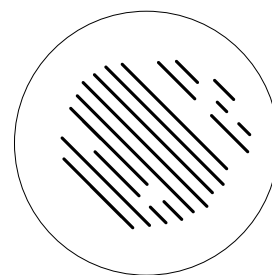
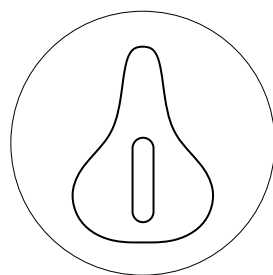
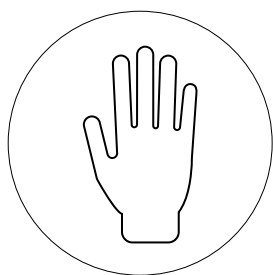
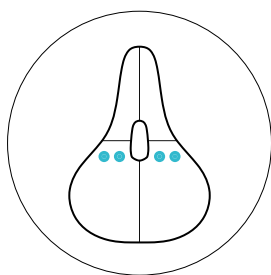

# Product range



ARTICLE	EAN	NAME	RIDING POSITION	GENDER	SIZES	PRICE (€)
2354HRMA10004	6957312801471	<b>Remed Sport</b>	Sport	Unisex	L 287mm / W 136mm / W 316g	26,90
4309DEMA10004	6957312801488	<b>Remed Trekking</b>	Trekking	Unisex	L 257mm / W 189mm / W 578g	26,90
5550UEMA10003	6957312801495	<b>Remed City</b>	City	Unisex	L 249mm / W 207mm / W 633g	26,90



fi'zi:k







L'ambizione di **fizik** è realizzare l'attrezzatura più attraente, fascinosa e tecnica per i ciclisti più esigenti del mondo.

L'ambition de **fizik** est de créer les composants les plus attrayants, les plus fascinants, les plus techniques pour les cyclistes les plus exigeants au monde.

*/fi'zi:k/*

L'espressione fonetica della parola "fi'zi:k" si riferisce alla forma o allo stato del corpo umano.

L'orthographe phonétique du mot "fi'zi:k" fait référence à la forme ou à l'état du corps humain.

Alle spalle della ricca linea prodotto fizik la passione per il design e la performance nel ciclismo su strada, nel fuoristrada e nel triathlon è espressa attraverso le innumerevoli vittorie di livello professionistico e i numerosi riconoscimenti per il design, che rendono fizik la scelta degli sportivi più ambiziosi.

Che sia un nastro manubrio o dei componenti, che sia una scarpa o delle selle, fizik si impegna a fornire il design e il comfort più evoluti assieme al comfort e alla leggerezza accoppiati con la tecnologia e l'innovazione.

È attraverso studi anatomici, ricerche di fisiologia e avanzati processi tecnologici che fizik ottiene la combinazione perfetta.

Che si tratti di sfidare se stessi o gli altri corridori, che siano professionisti o amatori, se sei alla ricerca della più attraente e tecnica attrezzatura da ciclismo, la risposta è fizik.

Derrière la riche gamme de produits fizik, la passion du design et de la performance en cyclisme, sur route, tout terrain et triathlon s'expriment à travers les innombrables victoires dans les rangs professionnels, ainsi que les nombreux prix de design faisant de fizik le choix des athlètes les plus performants et ambitieux.

Qu'il s'agisse de ruban pour guidon, de composants, de chaussures ou de selles, fizik est toujours à même de réaliser le summum en matière de design, réunissant confort et légèreté associés à la technologie et l'innovation.

C'est grâce à des études anatomiques, à la recherche physiologique et des processus technologique à l'avant garde que fizik parvient à la combinaison parfaite.

Que vous lanciez un défi à vous même ou à d'autres cyclistes, professionnels ou amateurs, et que vous êtes à la recherche du matériel le plus attrayant et le plus performant, la réponse est fizik.

# **SERIES**

Ogni ciclista in cerca di **bellezza e prestazioni**:  
è per lui che Fizik progetta prodotti e con lui  
che si impegna a dialogare.

Ci sono molti tipi di ciclisti, ognuno con diversi  
desideri, attitudine e bisogni.

Abbiamo costruito sia la nostra gamma di  
prodotti sia la nostra comunicazione intorno a  
queste esigenze.

Fizik conçoit des produits pour, et s'engage  
avec tous les cyclistes en quête de **beauté** et  
de **performance**.

Il existe de nombreux types de cyclistes,  
chacun avec des désirs, des attitudes et des  
besoins différents.

Nous avons organisé notre gamme de produits  
et notre communication autour de ces besoins

# SERIES



## VENTO

Linea RACING, disegnata in collaborazione con i ciclisti professionisti.

Ligne RACING conçue en collaboration avec des cyclistes professionnels.

DISCIPLINE/DISCIPLINES:  
Road Cycling, XC, CX



## TEMPO

Linea ROAD, disegnata per assicurare l'esperienza di guida più divertente e versatile.

Ligne ROAD conçue pour offrir le plaisir de pédaler dans toutes les situations.

DISCIPLINE/DISCIPLINES:  
Road Riding, Randonnée



## TERRA

Linea ALL-TERRAIN, disegnata per portarti oltre i tuoi limiti.

Ligne TOUT-TERRAIN conçue pour vous permettre dépasser vos limites.

DISCIPLINE/DISCIPLINES:  
Gravel, All-Mountain, eMTB



## GRAVITA

Linea GRAVITY, disegnata per farti scendere giù dai monti veloce e in sicurezza.

Ligne GRAVITY conçue pour dévaler la montagne à vitesse élevée, en toute maîtrise.

DISCIPLINE/DISCIPLINES:  
Enduro, Downhill



## TRANSIRO

Linea TRIATHLON, disegnata per prestazioni in bici senza compromessi e transizioni efficienti.

Ligne TRIATHLON conçue pour des performances à vélo optimales et des transitions efficaces.

DISCIPLINE/DISCIPLINES:  
Triathlon, Ironman



# SADDLES



# SHAPES

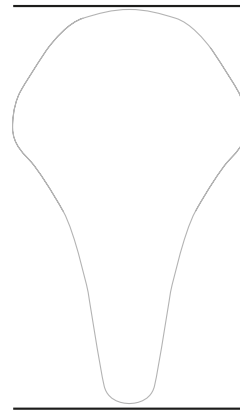

## SHORT NOSE

Sella a punta corta per un posizionamento in sella confortevole e stabile, in grado di garantire una migliore distribuzione del peso e un maggiore sostegno delle ossa ischiatiche rispetto a una sella tradizionale. La sella corta permette al ciclista di sedersi in posizione più avanzata senza sottoporre a pressioni eccessive le aree sensibili.

Une selle à bec court place le cycliste dans une position plus ancrée, ce qui permet une plus grande stabilité, une meilleure répartition du poids et un soutien ischiatique plus généreux par rapport à une selle traditionnelle. La selle courte permet au cycliste de s'asseoir plus en avant sans exercer une pression excessive sur les tissus sensibles.

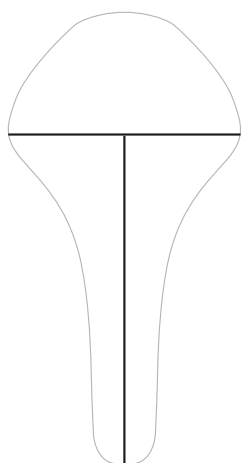

## T-SHAPE

Una sella ad alte prestazioni dalla forma aerodinamica e affusolata. Progettata per garantire la massima reattività in ogni condizione di gara.

Une selle haute performance avec une forme profilée et une transition bec-bords effilée. Conçue pour permettre une sensation de réactivité dans toutes les conditions de course.

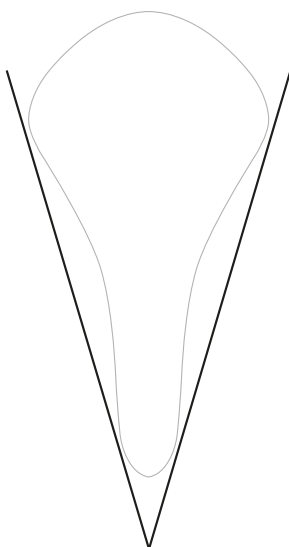

## V-SHAPE

Sella caratterizzata da una transizione graduale e affusolata da coda a punta. Con una base di appoggio leggermente più ampia per sostenere le ossa ischiatiche.

Une selle qui présente une transition graduelle et effilée des bords au bec. Avec une plateforme légèrement plus large pour soutenir les os ischiatiques.

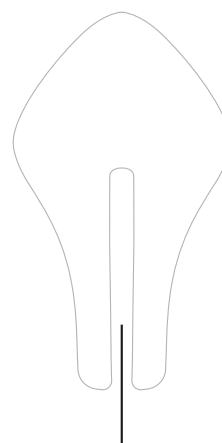

## SPLIT NOSE

Sella con punta doppia. Le due metà indipendenti costituiscono un sistema di scarico della pressione senza precedenti, pur garantendo il sostegno e l'equilibrio necessari per affrontare lunghe ore in posizione aerodinamica.

Selle conçue avec un nez divisé. Les deux moitiés indépendantes permettent un système d'allègement de la pression sans précédent tout en continuant à maintenir le soutien ferme et l'équilibre nécessaires pour de longues heures passées en position aérodynamique.

# SURFACES

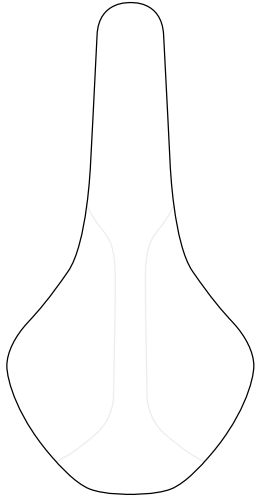

## SOLID

Costruzione handmade per una trasmissione di potenza ottimale, unita a un'imbottitura resiliente che distribuisce anche il peso del corpo.

Une fabrication artisanale pour un transfert de puissance optimal accouplé à un rembourrage élastique favorisant une répartition uniforme du poids du corps.

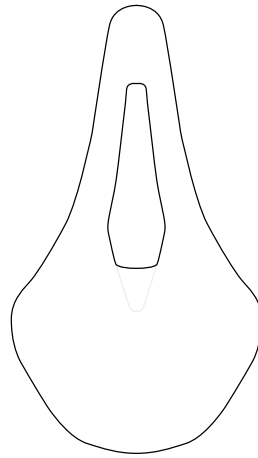

## CUT-OUT

Taglio ergonomico, sviluppato usando dettagliate analisi di pressione e input di esperti in medicina, che scarica la pressione sui tessuti molli.

La découpe ergonomique, développée à partir d'une analyse détaillée de la pression et des conclusions d'experts médicaux, permet de soulager la pression sur les tissus mous.

# RAILS

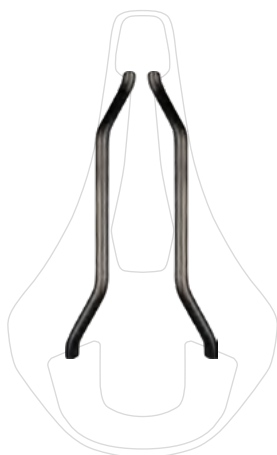

## CARBON

Al posto di quello convenzionale in tubo solido o cavo, i telai fizik utilizzano un rivestimento esterno di carbonio intrecciato che forma un tubo internamente cavo realizzato con fibre di carbonio unidirezionale. È una costruzione robusta, leggera e rigida.

Au lieu du conventionnel tube plein ou creux, les rails fizik sont réalisés à partir de fibres de carbone unidirectionnelles tressées formant un tube intérieur creux. C'est une construction robuste, légère et rigide.

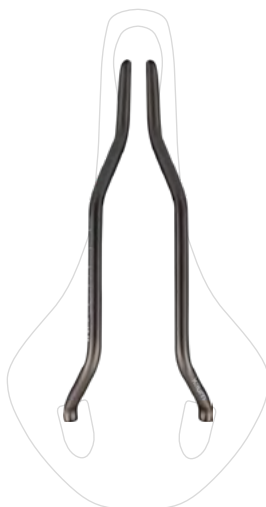

## KIUM

Kium è il risultato di una particolare lega metallica unita a un design specifico a tubolare e a uno speciale processo di finitura che aumenta la resistenza del binario. Ciò consente di ridurre il peso dell'8% rispetto al titanio solido, garantendo un elevato rapporto forza-peso e un'alta resistenza alla corrosione.

Kium est la combinaison d'un alliage métallique particulier, d'une conception tubulaire spécifique et d'un processus de finition spécial qui augmente la résistance à la fatigue du rail. Cela permet un gain de poids de 8 % par rapport au titane plein, garantissant un compromis élevé entre robustesse et légèreté et haute résistance à la corrosion.

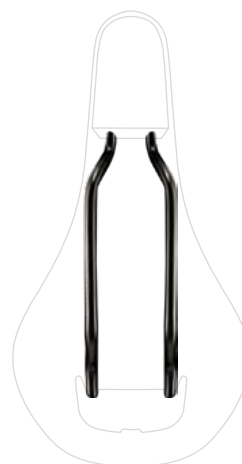

## S-ALLOY

Questa lega metallica è una miscela brevettata a base di ferro, carbonio (0,2%) e altri minerali, come cromo e molibdeno. Il basso contenuto di carbonio, combinato a uno specifico trattamento di finitura, consente di ottenere un binario robusto e altamente resistente alla corrosione.

Cet alliage métallique spécifique est un composé exclusif d'acier, de carbone (0,2%) et d'autres minéraux tels le chrome et le molybdène. La faible teneur en carbone associée à un traitement de surface spécifique procure au rail une résistance élevée à la corrosion.

# ROAD AND TRIATHLON SADDLES

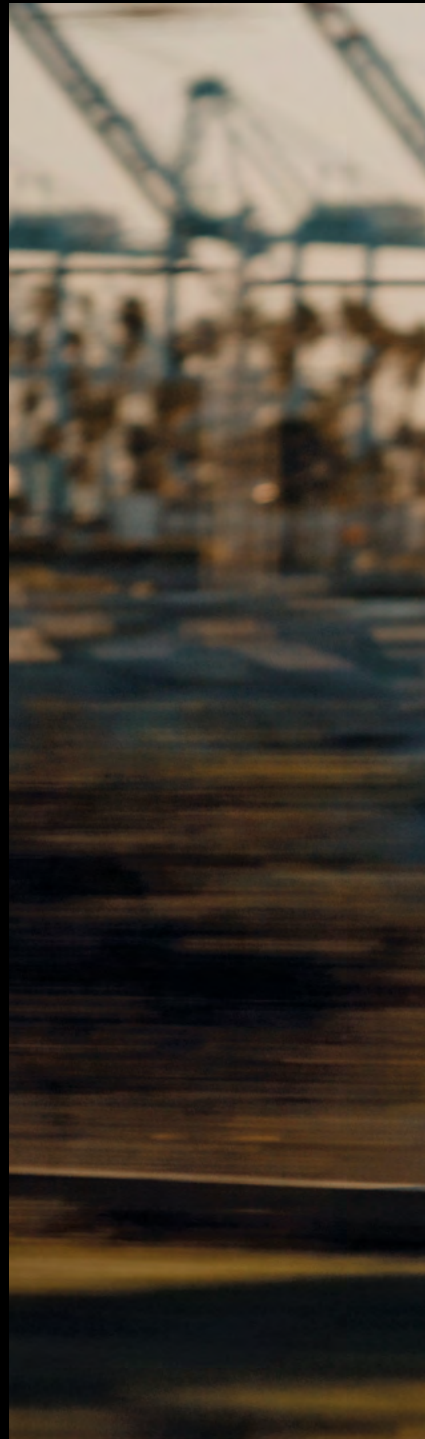





## VENTO ARGO ADAPTIVE

Una sella performante, a punta corta, che presenta la rivoluzionaria struttura Adaptive stampata in 3D, per offrire un comfort migliorato e maggiore stabilità, grazie a zone di assorbimento specifiche.

Une selle performante à nez court dotée du rembourrage révolutionnaire 3D-printed Adaptive pour un amorti zonal sans faille, un confort amélioré et une plus grande stabilité.



**VENTO**  
**ARGO 00**  
**ADAPTIVE**

Intended use: ROAD RACING

**Regular**  
L 265mm | W 140mm | W 175g  
**Large**  
L 265mm | W 150mm | W 186g



**VENTO**  
**ARGO R1**  
**ADAPTIVE**

Intended use: ROAD RACING, XC, CX

**Regular**  
L 265mm | W 140mm | W 190g  
**Large**  
L 265mm | W 150mm | W 196g



**VENTO**  
**ARGO R3**  
**ADAPTIVE**

Intended use: ROAD RACING, XC, CX

**Regular**  
L 265mm | W 140mm | W 224g  
**Large**  
L 265mm | W 150mm | W 230g



ARTICLE	EAN	MODEL	SIZE	COLOR	RAILS	SHELL	PADDING	SRP (€)
77F1D00A0P003	8021890583536	<b>Vento Argo 00 Adaptive</b>	<b>140mm</b>	Black	Carbon Mobius 7x9mm	Full Carbon	Adapitve padding	399
77F2D00A0P003	8021890583543		<b>150mm</b>					399
70F1D00A0P002	8021890571090	<b>Vento Argo R1 Adaptive</b>	<b>140mm</b>	Black	Carbon 7x9mm	Carbon Reinforced Nylon with WingFlex	Adapitve padding	299
70F2D00A0P002	8021890571113		<b>150mm</b>					299
70F1D00A1P002	8021890571106	<b>Vento Argo R3 Adaptive</b>	<b>140mm</b>	Black	Kium 7x7mm	Carbon Reinforced Nylon with WingFlex	Adapitve padding	259
70F2D00A1P002	8021890571120		<b>150mm</b>					259

## VENTO ARGO

Vento Argo è stata sviluppata per ottenere una sensazione di riding che si adatta alle bici da corsa con una geometria aggressiva.

Il deliberato obiettivo del suo design ti aiuta ad ottenere un migliore assetto: il naso ribassato supporta il ramo pubico quando le pelvi ruotano in avanti per aumentare la potenza oppure per una posizione più aero.

Vento Argo a été conçue pour offrir la sensation de guidage qui convient aux vélos de course à géométrie agressive.

La forme spécifique de sa conception aide à obtenir la meilleur position de guidage: le nez plongeant soutient la branche pubienne lorsque le bassin pivote vers l'avant pour gagner de la puissance et obtenir plus d'aérodynamisme.



**VENTO**  
**ARGO 00**

Intended use: ROAD RACING

**Regular**

L 265mm | W 140mm | W 134g

**Large**

L 265mm | W 150mm | W 139g



**VENTO**  
**ARGO R1**

Intended use: ROAD RACING

**Regular**

L 265mm | W 140mm | W 179g

**Large**

L 265mm | W 150mm | W 186g



**VENTO**  
**ARGO R3**

Intended use: ROAD RACING

**Regular**

L 265mm | W 140mm | W 213g

**Large**

L 265mm | W 150mm | W 220g



**VENTO**  
**ARGO R5**

Intended use: ROAD RACING

**Regular**

L 265mm | W 140mm | W 225g

**Large**

L 265mm | W 150mm | W 232g



ARTICLE	EAN	MODEL	SIZE	COLOR	RAILS	SHELL	PADDING	SRP (€)
77D7Y00A0E000	8021890499271	<b>Vento Argo 00</b>	<b>140mm</b>	Black	Carbon Mobius 7x9mm	Full Carbon	EVA padding	299
77D8Y00A0E000	8021890499288		<b>150mm</b>					299
70D7S00A03A23	8021890486486	<b>Vento Argo R1</b>	<b>140mm</b>	Black	Carbon 7x9mm	Carbon Reinforced Nylon with WingFlex	Type 1	199
70D8S00A03A23	8021890486516		<b>150mm</b>					199
70D7S00A13A22	8021890486493	<b>Vento Argo R3</b>	<b>140mm</b>	Black	Kium 7x7mm	Carbon Reinforced Nylon with WingFlex	Type 1	149
70D8S00A13A22	8021890486523		<b>150mm</b>					149
70D7S00A23A22	8021890486509	<b>Vento Argo R5</b>	<b>140mm</b>	Black	S-Alloy 7x7mm	Carbon Reinforced Nylon with WingFlex	Type 1	109
70D8S00A23A22	8021890486530		<b>150mm</b>					109

## TEMPO ARGO

Come opzione per la guida endurance Tempo Argo è stata sviluppata per assicurare una sensazione di marcia adatta per la geometria equilibrata che contraddistingue le versatili biciclette da corsa attuali.

L'imbottitura è leggermente più sottile attorno all'area delle prominenze ischiatiche al fine di supportare una posizione di guida più eretta, assicurando maggiore comfort sulle lunghe distanze.

En option pour la pratique d'endurance, Tempo Argo a été développée pour assurer une perception adaptée à la géométrie équilibrée qui caractérise les vélos de course polyvalents d'aujourd'hui.

Le rembourrage est plus fin autour des zones des proéminences ischiatiques afin de soutenir une position de pédalage plus droite, assurant un plus grand confort sur de longues distances.

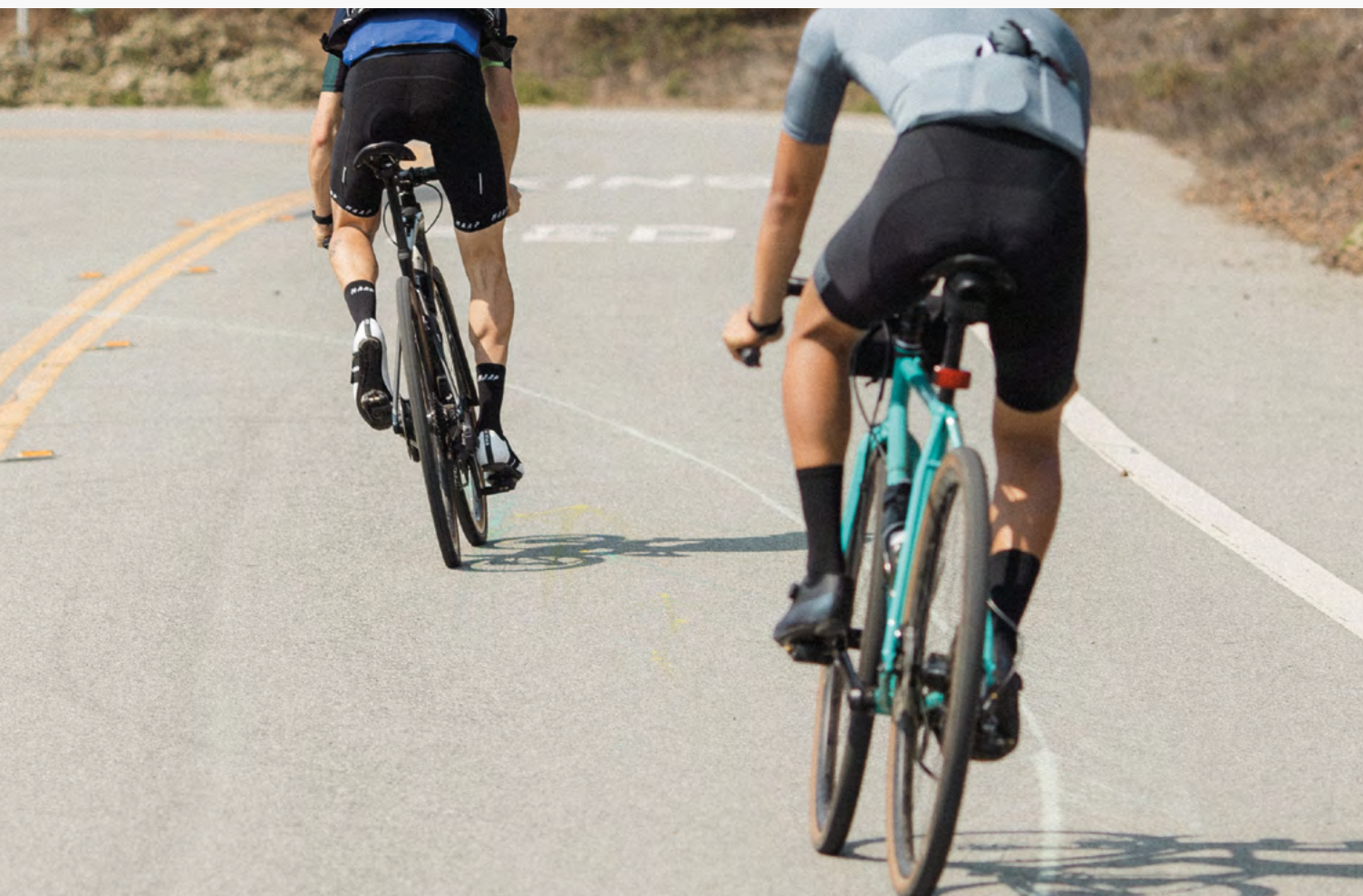

**TEMPO**  
**ARGO R1**

Intended use: ROAD

**Regular**

L 260mm | W 150mm | W 195g

**Large**

L 260mm | W 160mm | W 202g



**TEMPO**  
**ARGO R3**

Intended use: ROAD

**Regular**

L 260mm | W 150mm | W 229g

**Large**

L 260mm | W 160mm | W 235g



**TEMPO**  
**ARGO R5**

Intended use: ROAD

**Regular**

L 260mm | W 150mm | W 241g

**Large**

L 260mm | W 160mm | W 247g



ARTICLE	EAN	MODEL	SIZE	COLOR	RAILS	SHELL	PADDING	SRP (€)
70D9S00A03A23	8021890486547	<b>Tempo Argo R1</b>	<b>150mm</b>	Black	Carbon Mobius 7x9mm	Carbon Reinforced Nylon with WingFlex	Type 2	199
70E0S00A03A23	8021890486578		<b>160mm</b>					199
70D9S00A13A22	8021890486554	<b>Tempo Argo R3</b>	<b>150mm</b>	Black	Kium 7x7mm	Carbon Reinforced Nylon with WingFlex	Type 2	149
70E0S00A13A22	8021890486585		<b>160mm</b>					149
70D9S00A23A22	8021890486561	<b>Tempo Argo R5</b>	<b>150mm</b>	Black	S-Alloy 7x7mm	Carbon Reinforced Nylon with WingFlex	Type 2	109
70E0S00A23A22	8021890486592		<b>160mm</b>					109

# ANTARES

Sella ad alte prestazioni con una forma aerodinamica e una transizione naso-ala affusolata, progettata per garantire reattività in ogni condizione di gara.

Une selle haute performance avec une forme profilée et une transition bec/bords effilée, conçue pour offrir une sensation de réactivité dans toutes les conditions de course.



**VENTO**  
**ANTARES 00**

Intended use: ROAD RACING, XC, CX

**Regular**

L 270mm | W 140mm | W 118g

**Large**

L 270mm | W 150mm | W 124g



**VENTO**  
**ANTARES R1**

Intended use: ROAD RACING, XC, CX

**Regular**

L 268mm | W 140mm | W 161g

**Large**

L 268mm | W 150mm | W 166g



**VENTO**  
**ANTARES R3**

Intended use: ROAD RACING, XC, CX

**Regular**

L 268mm | W 140mm | W 195g

**Large**

L 268mm | W 150mm | W 202g



**VENTO**  
**ANTARES R5**

Intended use: ROAD RACING, XC, CX

**Regular**

L 268mm | W 140mm | W 210g

**Large**

L 268mm | W 150mm | W 217g



ARTICLE	EAN	MODEL	SIZE	COLOR	RAILS	SHELL	PADDING	SRP (€)
77E9Y00A0E000	8021890580375	<b>Vento Antares 00</b>	<b>140mm</b>	Black	Carbon 7x9mm	Full Carbon Shell	Injected EVA	299
77F0Y00A0E000	8021890580382		<b>150mm</b>					299
75E5S00A03A25	8021890580191	<b>Vento Antares R1</b>	<b>140mm</b>	Black	Carbon 7x9mm	Carbon Reinforced Nylon with WingFlex	Double-density foam	199
75E6S00A03A25	8021890580221		<b>150mm</b>					199
75E5S00A13A25	8021890580207	<b>Vento Antares R3</b>	<b>140mm</b>	Black	Kium 7x7mm	Carbon Reinforced Nylon with WingFlex	Double-density foam	149
75E6S00A13A25	8021890580238		<b>150mm</b>					149
75E5S00A23A25	8021890580214	<b>Vento Antares R5</b>	<b>140mm</b>	Black	S-Alloy 7x7mm	Carbon Reinforced Nylon with WingFlex	Double-density foam	109
75E6S00A23A25	8021890580245		<b>150mm</b>					109



# ALIANTE

Aliante è una sella da ciclismo su strada endurance dal profilo ondulato, dotata di foro per alleviare la pressione e schiuma a doppia densità per il massimo del comfort anche durante le uscite più lunghe.

L'Aliante est une selle de vélo de route d'endurance avec un profil ondulé conçu pour maximiser le confort, avec une découpe d'allégement de la pression et une mousse à double densité qui rendent les sorties les plus longues agréables.



**TEMPO**  
**ALIANTE R1**

Intended use: ROAD

**Regular**

L 277mm | W 145mm | W 180g

**Large**

L 277mm | W 155mm | W 186g



**TEMPO**  
**ALIANTE R3**

Intended use: ROAD

**Regular**

L 277mm | W 145mm | W 220g

**Large**

L 277mm | W 155mm | W 226g



**TEMPO**  
**ALIANTE R5**

Intended use: ROAD

**Regular**

L 277mm | W 145mm | W 230g

**Large**

L 277mm | W 155mm | W 236g



ARTICLE	EAN	MODEL	SIZE	COLOR	RAILS	SHELL	PADDING	SRP (€)
75E7S00A03A25	8021890580252	<b>Tempo Aliante R1</b>	<b>145mm</b>	Black	Carbon 7x9mm	Carbon Reinforced Nylon with WingFlex	Double-density foam	199
75E8S00A03A25	8021890580283		<b>155mm</b>					199
75E7S00A13A25	8021890580269	<b>Tempo Aliante R3</b>	<b>145mm</b>	Black	Kium 7x7mm	Carbon Reinforced Nylon with WingFlex	Double-density foam	149
75E8S00A13A25	8021890580290		<b>155mm</b>					149
75E7S00A23A25	8021890580276	<b>Tempo Aliante R5</b>	<b>145mm</b>	Black	S-Alloy 7x7mm	Carbon Reinforced Nylon with WingFlex	Double-density foam	109
75E8S00A23A25	8021890580306		<b>155mm</b>					109

## ARIONE

Una sella con profilo piatto progettata per ciclisti con elevata flessibilità del corpo e senza rotazione pelvica durante la pedalata.

Une selle à profil plat conçue pour les cyclistes ayant une grande flexibilité corporelle et sans rotation du bassin pendant le pédalage.



## ARIONE 00

Intended use: ROAD RACING

L 298mm | W 124mm | W 140g



## ARIONE R1

Intended use: ROAD RACING

Regular

L 300mm | W 126mm | W 165g

Large

L 300mm | W 140mm | W 175g



## ARIONE R3

Intended use: ROAD RACING

Regular

L 300mm | W 126mm | W 200g

Large

L 300mm | W 140mm | W 210g



## ARIONE CLASSIC

Intended use: ROAD RACING

L 300mm | W 132mm | W 235g



ARTICLE	EAN	MODEL	SIZE	COLOR	RAILS	SHELL	PADDING	SRP (€)
7092SWSA19C65	8021890428127	<b>Arione 00</b>	-	Black/ Anthracite	Carbon Mobius 7x10mm	Full Carbon	Type 1	299
76B5SWSA09C65	8021890443861	<b>Arione R1</b>	<b>Regular</b>	Black	Carbon Braided 7x10mm	Thermoplastic Carbon Composite with WingFlex	Type 1	199
76BOSWSA09E12	8021890443830		<b>Large</b>					199
74B5SWSA09F04	8021890443816	<b>Arione R3</b>	<b>Regular</b>	Black	Kium 7x7mm	Thermoplastic Carbon Composite with WingFlex	Type 1	149
74BOSWSA09C65	8021890443786		<b>Large</b>					149
7014SXSD99640	8021890276308	<b>Arione Classic</b>	-	Black	Kium 7x7mm	Carbon Reinforced Nylon with WingFlex	Type 1	129

# ARIONE OPEN

Open è una costruzione fatta a mano per un trasferimento di potenza ottimale unito con un design spaccato che scarica la pressione sui tessuti molli.

Open une fabrication artisanale pour une transmission de puissance optimale associée à une conception en deux parties qui soulage la pression sur les tissus mous.



## ARIONE R1 OPEN

Intended use: ROAD RACING

**Regular**

L 300mm | W 132mm | W 199g

**Large**

L 298mm | W 142mm | W 205g



## ARIONE R3 OPEN

Intended use: ROAD

**Regular**

L 300mm | W 132mm | W 230g

**Large**

L 298mm | W 142mm | W 240g



ARTICLE	EAN	MODEL	SIZE	COLOR	RAILS	SHELL	PADDING	SRP (€)
70COS00A03A02	8021890455642	<b>Arione R1 Open</b>	<b>Regular</b>	Black	Carbon Braided 7x10mm	Carbon Reinforced Nylon with WingFlex	Type 1	199
70DOS00A03A02	8021890455703		<b>Large</b>					199
70COS00A13041	8021890455659	<b>Arione R3 Open</b>	<b>Regular</b>	Black	Kium 7x7mm	Carbon Reinforced Nylon with WingFlex	Type 1	149
70DOS00A13041	8021890455710		<b>Large</b>					149
70COS00A13038	8021890460233	<b>Arione R3 Open</b>	<b>Regular</b>	White	Kium 7x7mm	Carbon Reinforced Nylon with WingFlex	Type 1	149
70DOS00A13038	8021890460264		<b>Large</b>					149

## AERIS LONG DISTANCE

Una sella da triathlon a naso sdoppiato progettata per fornire maggiore sostegno e stabilità quando si pedala in posizioni di guida avanzate e aerodinamiche.

Une selle de triathlon à bec divisé, conçue pour offrir un meilleur soutien et une plus grande stabilité lors des courses en position avancée et aérodynamique.



**TRANSIRO**  
**AERIS LD R1**

Intended use: TRIATHLON / TIME TRIAL

L 244mm | W 135mm | W 181g



**TRANSIRO**  
**AERIS LD R3**

Intended use: TRIATHLON / TIME TRIAL

L 244mm | W 135mm | W 212g



**TRANSIRO**  
**AERIS LD R5**

Intended use: TRIATHLON / TIME TRIAL

L 244mm | W 135mm | W 218g



ARTICLE	EAN	MODEL	SIZE	COLOR	RAILS	SHELL	PADDING	SRP (€)
75F3S00A03A25	8021890580313	<b>Transiro AERIS LD R1</b>	<b>135mm</b>	Black	Carbon 7x9mm	Carbon Reinforced Nylon	Type 1	199
75F3S00A13A25	8021890580320	<b>Transiro AERIS LD R3</b>	<b>135mm</b>	Black	Kium 7x7mm	Carbon Reinforced Nylon	Type 1	149
75F3S00A23A25	8021890580337	<b>Transiro AERIS LD R5</b>	<b>135mm</b>	Black	S-Alloy 7x7mm	Carbon Reinforced Nylon	Type 1	109



## AERIS SHORT DISTANCE

Una sella che favorisce massima stabilità e supporto a chi gareggia nelle competizioni a cronometro e di triathlon e cerca una piattaforma ottimale da cui erogare potenza in posizioni di guida avanzate e aerodinamiche.

Selle conçue pour offrir une stabilité et un soutien maximum aux coureurs de contre-la-montre et aux triathlètes qui ont besoin d'une plateforme optimale pour délivrer leur puissance dans des positions de conduite aérodynamiques et avancées.



**TRANSIRO**  
**AERIS SD R1**

Intended use: TRIATHLON / TIME TRIAL

L 245mm | W 135mm | W 170g



**TRANSIRO**  
**AERIS SD R3**

Intended use: TRIATHLON / TIME TRIAL

L 245mm | W 135mm | W 199g



**TRANSIRO**  
**AERIS SD R5**

Intended use: TRIATHLON / TIME TRIAL

L 245mm | W 135mm | W 209g



ARTICLE	EAN	MODEL	SIZE	COLOR	RAILS	SHELL	PADDING	SRP (€)
75F4S00A03A25	8021890580344	<b>Transiro Aeris SD R1</b>	<b>135mm</b>	Black	Carbon 7x9mm	Carbon Reinforced Nylon	Type 1	199
75F4S00A13A25	8021890580351	<b>Transiro Aeris SD R3</b>	<b>135mm</b>	Black	Kium 7x7mm	Carbon Reinforced Nylon	Type 1	149
75F4S00A23A25	8021890580368	<b>Transiro Aeris SD R5</b>	<b>135mm</b>	Black	S-Alloy 7x7mm	Carbon Reinforced Nylon	Type 1	109

# OFF-ROAD SADDLES



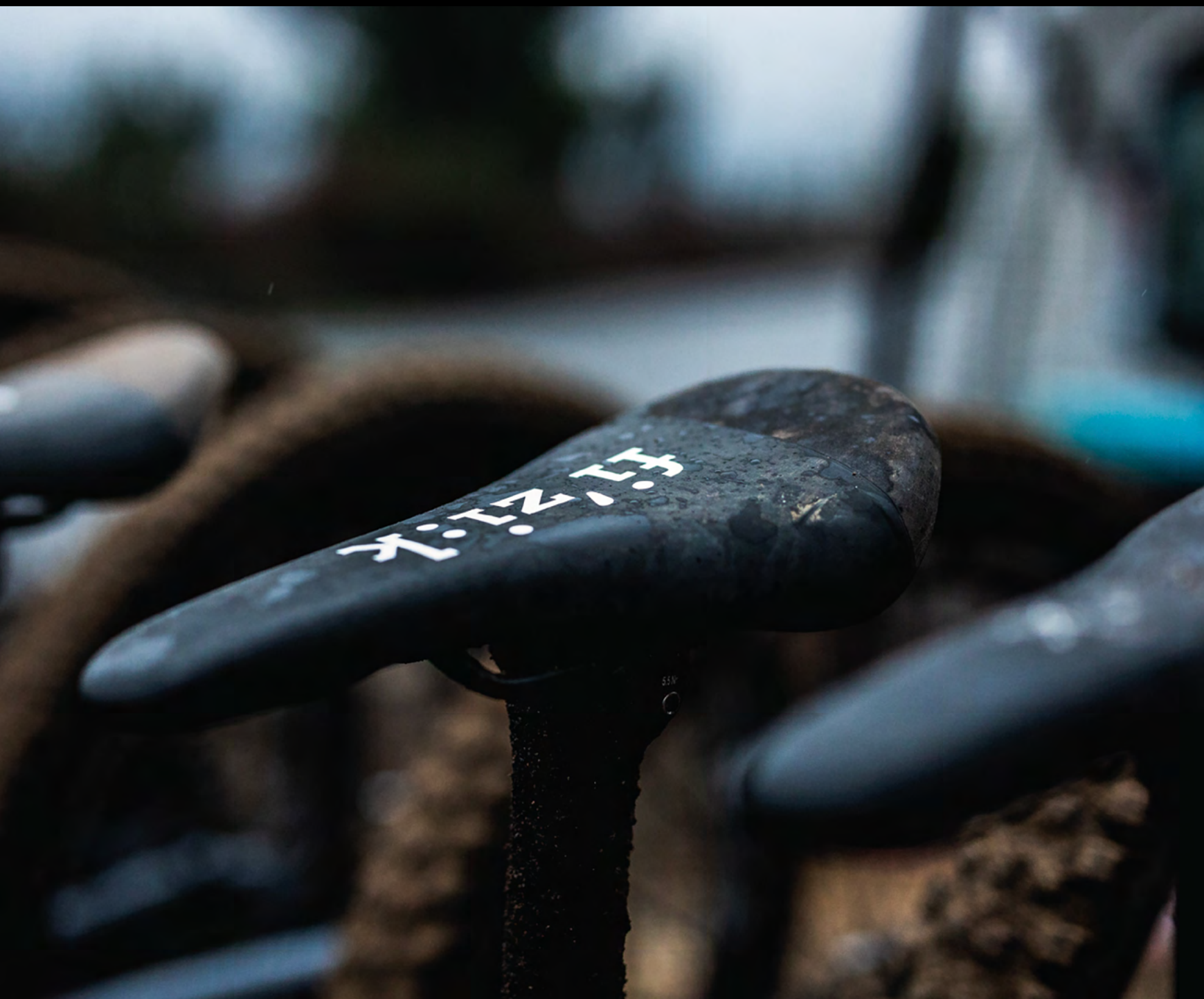

## VENTO ARGO X NEW

Una sella off-road performante con un design a punta corta che migliora la stabilità e consente una posizione di guida più aggressiva.

Une selle de course tout-terrain performante avec un nez court qui améliore la stabilité et permet une position de conduite plus agressive.



**VENTO**  
**ARGO X1**

Intended use: OFF-ROAD RACING

**Regular**

L 265mm | W 140mm | W 192g

**Large**

L 265mm | W 150mm | W 198g



**VENTO**  
**ARGO X3**

Intended use: OFF-ROAD RACING

**Regular**

L 265mm | W 140mm | W 231g

**Large**

L 265mm | W 150mm | W 237g



**VENTO**  
**ARGO X5**

Intended use: OFF-ROAD RACING

**Regular**

L 265mm | W 140mm | W 240g

**Large**

L 265mm | W 150mm | W 246g



ARTICLE	EAN	NEW	MODEL	SIZE	COLOR	RAILS	SHELL	PADDING	SRP (€)
F212URNA27881	6957312803291	<b>NEW</b>	<b>Vento Argo X1</b>	<b>140mm</b>	Black	Carbon 7x9mm	Fiber Reinforced Nylon with WingFlex	Type 1	199
F213URNA27881	6957312803314	<b>NEW</b>		<b>150mm</b>					199
F212URNA17881	6957312803277	<b>NEW</b>	<b>Vento Argo X3</b>	<b>140mm</b>	Black	Kium 7x7mm	Fiber Reinforced Nylon with WingFlex	Type 1	149
F213URNA17881	6957312803284	<b>NEW</b>		<b>150mm</b>					149
F212URNA07881	6957312803253	<b>NEW</b>	<b>Vento Argo X5</b>	<b>140mm</b>	Black	S-Alloy 7x7mm	Fiber Reinforced Nylon with WingFlex	Type 1	109
F213URNA07881	6957312803260	<b>NEW</b>		<b>150mm</b>					109

## TERRA ARGO

Come opzione per le gravel bike, la Terra Argo è stata sviluppata con un particolare scafo che offre un certo grado di flessibilità.

Questa elasticità controllata assorbe le buche e le vibrazioni della strada, assicurando il comfort necessario per le uscite di lunga distanza, su strade non asfaltate.

En option pour les vélos gravel, la Terra Argo a été développée avec une coque particulière qui offre une certaine flexibilité.

Cette élasticité contrôlée absorbe les nids-de-poule et les vibrations de la route, assurant le confort nécessaire pour les longues distances, sur les routes non goudronnées.



**TERRA**  
**ARGO X1**

Intended use: GRAVEL

**NEW SIZE**

L 270mm | W 140mm | W 210g

**Regular**

L 270mm | W 150mm | W 215g

**Large**

L 270mm | W 160mm | W 225g



**TERRA**  
**ARGO X3**

Intended use: GRAVEL

**NEW SIZE**

L 270mm | W 140mm | W 253g

**Regular**

L 270mm | W 150mm | W 258g

**Large**

L 270mm | W 160mm | W 262g



**TERRA**  
**ARGO X5**

Intended use: GRAVEL

**NEW SIZE**

L 270mm | W 140mm | W 265g

**Regular**

L 270mm | W 150mm | W 271g

**Large**

L 270mm | W 160mm | W 275g



ARTICLE	EAN	NEW	MODEL	SIZE	COLOR	RAILS	SHELL	PADDING	SRP (€)
70F9S00A03A22	8021890590077	<b>NEW</b>	<b>Terra Argo X1</b>	<b>140mm</b>	Black	Carbon 7x9mm	Carbon Reinforced Nylon with WingFlex	Type 2	199
70E1S00A23A22	8021890571199			<b>150mm</b>					199
70E2S00A23A22	8021890571205			<b>160mm</b>					199
70F9S00A13A22	8021890590084	<b>NEW</b>	<b>Terra Argo X3</b>	<b>140mm</b>	Black	Kium Mobius 7x7mm	Carbon Reinforced Nylon with WingFlex	Type 2	149
70E1S00A03A22	8021890498052			<b>150mm</b>					149
70E2S00A03A22	8021890498076			<b>160mm</b>					149
70F9S00A23A22	8021890590091	<b>NEW</b>	<b>Terra Argo X5</b>	<b>140mm</b>	Black	S-Alloy Mobius 7x7mm	Carbon Reinforced Nylon with WingFlex	Type 2	109
70E1S00A13A22	8021890486615			<b>150mm</b>					109
70E2S00A13A22	8021890486639			<b>160mm</b>					109



# ALPACA

Una sella da mountain bike con una forma dal bordo arrotondato, da utilizzare in combinazione con il reggisela telescopico, che unisce supporto e controllo della bici.

Une selle de VTT avec une forme à bords lisses qui combine le soutien et le contrôle de la conduite pour l'utilisation de la tige de selle télescopique.



**TERRA**  
**ALPACA X5**  
**+ CARRIAGE KIT**

Intended use: ENDURO, ALL-MOUNTAIN

L 248mm | W 145mm | W 230g



**GRAVITA**  
**ALPACA X5**  
**+ CARRIAGE KIT**

Intended use: ENDURO, DOWNHILL

L 251mm | W 130mm | W 216g

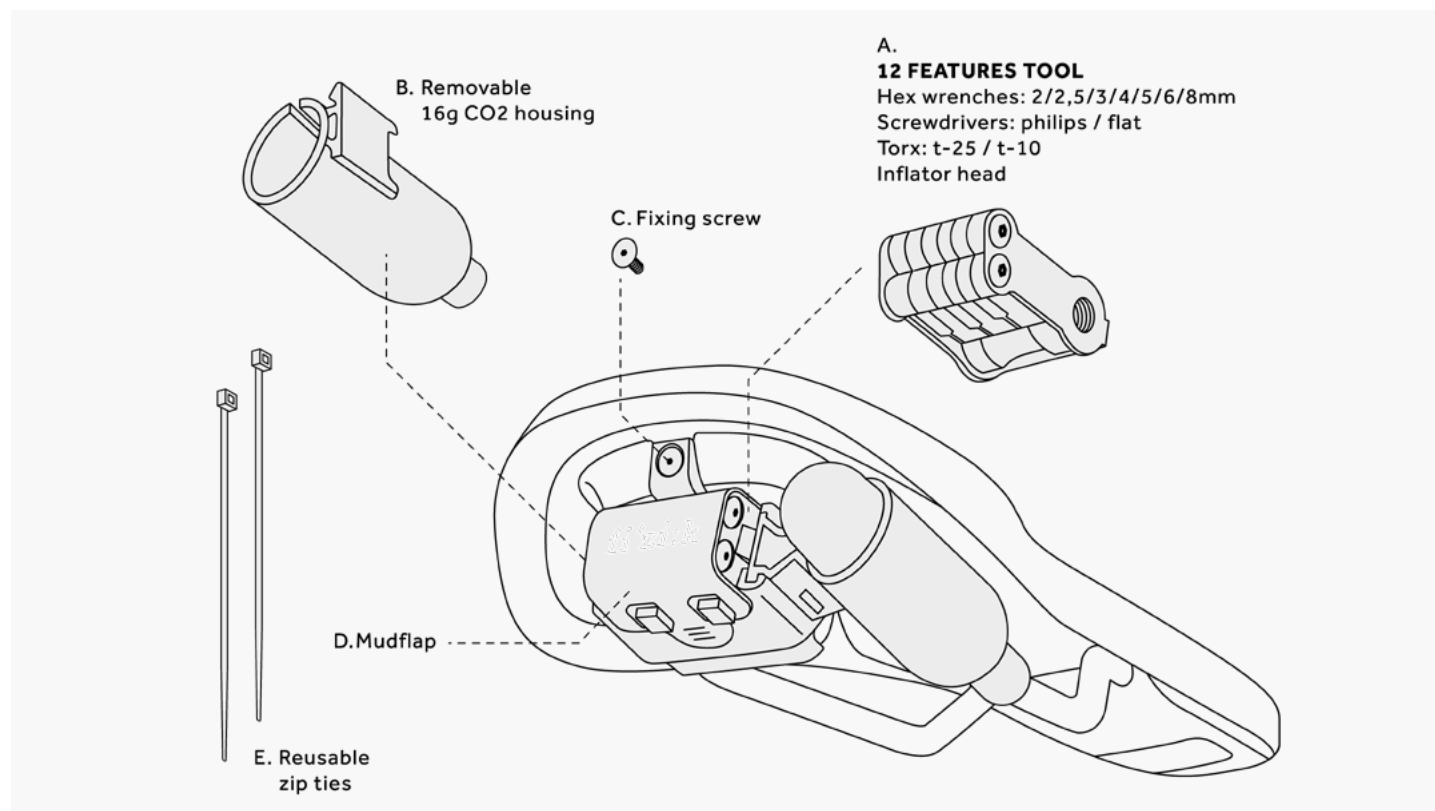

ARTICLE	EAN	MODEL	COLOR	RAILS	SHELL	PADDING	SRP (€)
F206URNA13814	6957312802447	<b>Terra Alpaca X5 + Carriage Kit</b>	Black	S-Alloy Mobius 7x7mm	Fiber Reinforced Nylon with EdgeFlex	Type 1	109
F205URNA13814	6957312802430	<b>Gravita Alpaca X5 + Carriage Kit</b>	Black	S-Alloy Mobius 7x7mm	Fiber Reinforced Nylon with EdgeFlex	Type 1	99

# AIDON

Aidon è una sella progettata per soddisfare le esigenze della pedalata assistita.

Aidon est une forme de selle conçue pour répondre aux besoins de l'assistance au pédalage.



**TERRA**  
**AIDON X1**

Intended use: E-MTB

**Regular**

L 255mm | W 145mm | W 205g

**Large**

L 255mm | W 160mm | W 215g



**TERRA**  
**AIDON X3**

Intended use: E-MTB

**Regular**

L 255mm | W 145mm | W 249g

**Large**

L 255mm | W 160mm | W 259g



**TERRA**  
**AIDON X5**

Intended use: E-MTB

**Regular**

L 255mm | W 145mm | W 262g

**Large**

L 255mm | W 160mm | W 272g



ARTICLE	EAN	MODEL	SIZE	COLOR	RAILS	SHELL	PADDING	SRP (€)
F208URNA24873	6957312802485	<b>Terra Aidon X1</b>	<b>145mm</b>	Black	Carbon Mobius 7x9mm	Fiber Reinforced Nylon with WingFlex	Type 2	179
F209URNA24873	6957312802515		<b>160mm</b>					179
F208URNA14873	6957312802478	<b>Terra Aidon X3</b>	<b>145mm</b>	Black	Kium Mobius 7x7mm	Fiber Reinforced Nylon with WingFlex	Type 2	139
F209URNA14873	6957312802508		<b>160mm</b>					139
F208URNA04873	6957312802461	<b>Terra Aidon X5</b>	<b>145mm</b>	Black	S-Alloy Mobius 7x7mm	Fiber Reinforced Nylon with WingFlex	Type 2	89
F209URNA04873	6957312802492		<b>160mm</b>					89

**VENTO**  
**ANTARES**  
**TEST KIT**

1 Vento Antares R5 140  
 1 Vento Antares R5 150



**TEMPO**  
**ALIANTE**  
**TEST KIT**

1 Tempo Aliante R5 145  
 1 Tempo Aliante R5 155



**TRANSIRO**  
**AERIS**  
**TEST KIT**

1 Transiro Aeris SD R5  
 1 Transiro Aeris LD R5



**VENTO & TEMPO**  
**ARGO**  
**TEST KIT**

1 Vento Argo R3 140  
 1 Vento Argo R3 150  
 1 Tempo Argo R3 150  
 1 Tempo Argo R3 160



**TERRA**  
**ARGO**  
**TEST KIT**

1 Terra Argo X3 150  
 1 Terra Argo X3 160



ARTICLE	EAN	MODEL	DESCRIPTION
FZKS000D30000	8021890580399	<b>Vento Antares Test Kit</b>	2 Vento Antares R5, both sizes, test cosmetics
FZKS000D40000	8021890580405	<b>Tempo Aliante Test Kit</b>	2 Tempo Aliante R5, both sizes, test cosmetics
FZKS000D50000	8021890580412	<b>Transiro Aeris Test Kit</b>	1x Transiro Aeris SD R5 and 1x Transiro Aeris LD R5, test cosmetics
FZKS000000000	8021890486448	<b>Vento &amp; Tempo Argo Test Kit</b>	4 R3 Vento e Tempo Argo Test Saddles (2 Regular + 2 Large)
FZKS000C50000	8021890498397	<b>Terra Argo Test Kit</b>	2 X3 Terra Argo Test Saddles (1 Regular + 1 Large)

## SADDLE BAG SMALL

Disegnata per alloggiare una camera d'aria, una cartuccia di CO2 e i levagomme.

Realizzata in durevole PU-rivestito in poliestere con cuciture saldate.

- Tasca interna in rete
- Zip idrorepellente
- Si aggancia sotto la sella con uno strap Velcro
- Volume di 0,4 litri
- Dimensioni 110x75x50 mm
- Peso: 66g

Conçu pour contenir une chambre à air, une cartouche de CO2 et les démonte pneus.

Fabriqué en polyester durable enduit de PU avec coutures soudées.

- Poche intérieure en filet
- Zip déperlant
- Il s'accroche sous la selle avec une sangle Velcro
- Volume de 0,4 litre
- Dimensions 110x75x50 mm
- Poids: 66g



## AERIS LINK

**NEW**

Weight: 14g

Permette l'attacco posteriore di un portaborraccia alle selle Aeris SD e LD.

Permet de fixer un porte-bidon à l'arrière des selles Aeris SD et LD.



## BOTTLE CAGE

Weight: 29g

Portaborraccia progettato per essere integrato alla sella Aeris, compatibile con tutti i supporti standard con filettatura a 2 fori.

Développé pour être intégré au maillon de la selle Aeris, ce porte-bidon est compatible avec tous les supports standards à 2 trous.



ARTICLE	EAN	NEW	MODEL	SIZE	COLOR	DESCRIPTION	SRP (€)
FB09000A00000	8021890497130		<b>fi'zi:k Saddle Bag</b>	One Size	Black	PU-coated polyester / inner mesh pocket / water repellent zipper / velcro straps	25
FZKS000D70000	8021890586698	<b>NEW</b>	<b>fi'zi:k Aeris Link</b>	One Size	Black	Enables rear attachment of a water bottle cage to Aeris SD and LD saddles	15
FZKS000D20000	8021890497130		<b>fi'zi:k Bottle Cage</b>	One Size	Black	Designed to be integrated with the Aeris saddle link, the bottle cage is compatible with all bike frames with standard 2 threaded holes	15

# **SADDLE FINDER**

SHOP SERIES DROPS STORIES ATHLETES

fi'zi:k

## SADDLE FINDER

**SECTION 1: RIDING GOALS**

What is the intended use for the saddle you're looking for?

Select

How often do you ride your bike?

Select

Noi di fizik vogliamo fornirti la migliore esperienza di guida possibile, ottimizzando salute, comfort e prestazioni.

Per aiutarti a **scegliere la tua sella ideale** abbiamo creato un semplice strumento che ti guida nel processo di scelta.

Chez fizik, nous croyons qu'il faut offrir la meilleure expérience de pilotage possible, en améliorant la santé, le confort et les performances.

Pour vous aider à **choisir votre selle idéale**, nous avons créé un outil simple qui vous guidera tout au long du processus.

Scopri di più su [www.fizik.com](http://www.fizik.com)  
o scansiona il codice.

Pour en savoir plus, consultez le site  
[www.fizik.com](http://www.fizik.com) ou scannez le code.





# SHOES



# CLOSURE SYSTEMS

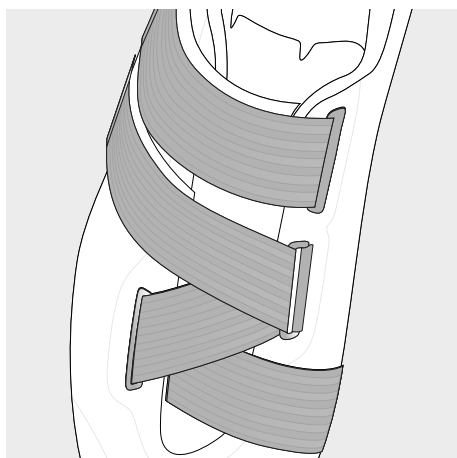

## POWERSTRAP

È un'innovativa chiusura Velcro disegnata per una calzata avvolgente. Mentre la maggior parte delle chiusure Velcro tengono semplicemente assieme due lati della tomaia, in questo caso un nastro si avvolge attorno al piede, garantendo un comfort e un contenimento superiori utilizzando solo due straps.

Il s'agit d'une fermeture Velcro innovante conçue pour un ajustement parfait. Alors que la plupart des fermetures Velcro maintiennent simplement deux côtés de la tige ensemble, dans ce cas, un ruban s'enroule autour du pied, assurant un confort et un ajustement supérieurs en utilisant seulement deux sangles.

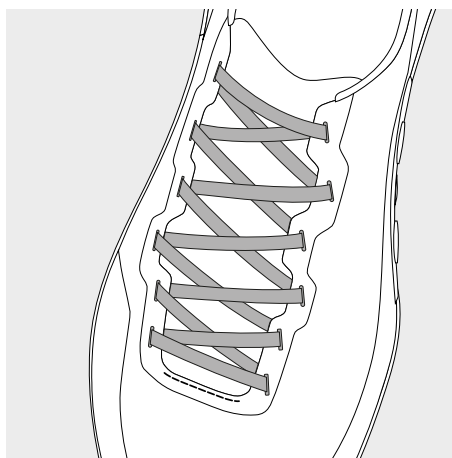

## LACE

I lacci avvolgono il piede e si adattano alla sua forma, assicurando una calzata naturale. In questo modo, la pressione viene distribuita in modo uniforme su tutto il piede, evitando la formazione di punti critici.

Les lacets enveloppent le pied et s'adaptent à une variété de formes de pieds, sécurisant l'ajustement avec une sensation plus naturelle. Avec les lacets, la pression est répartie uniformément sur l'ensemble du pied, sans créer de points de chaleur.

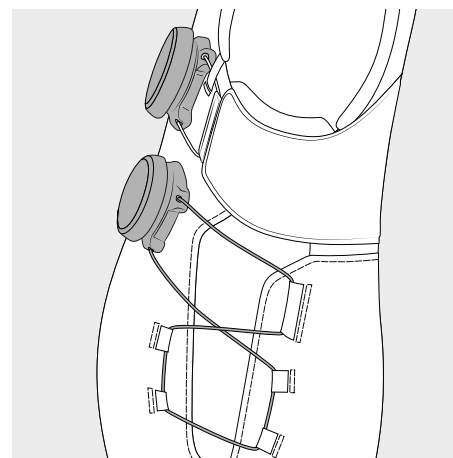

## DOUBLE BOA

Permette di regolare separatamente la calzata per le aree del collo del piede e dell'avampiede, la cui forma e volume possono variare notevolmente da un ciclista all'altro. Attraverso il controllo di due chiusure BOA indipendenti, il ciclista può regolare con precisione la calzata della scarpa in base alla forma del proprio piede, per comfort e sostegno personalizzati.

Permet un réglage différencié de l'ajustement pour les zones du cou-de-pied et de l'avant-pied, dont la forme et le volume peuvent varier considérablement d'un cycliste à l'autre. En contrôlant les deux cadrans BOA distincts, les cyclistes peuvent adapter la chaussure à la forme unique de leur pied pour un confort et un soutien personnalisés.

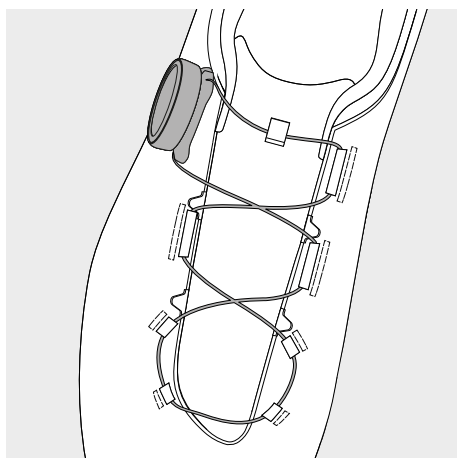

## SINGLE BOA

Un sistema di chiusura veloce e sicuro, grazie alla chiusura BOA micro-regolabile che garantisce una vestibilità perfetta.

Un système de fermeture rapide et sûr, alimenté par une molette BOA micro-réglable pour un ajustement précis.

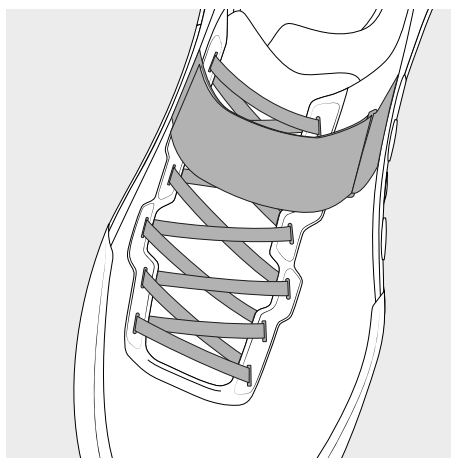

## LACES + STRAP

Un sistema di allacciatura ergonomico che avvolge il piede e distribuisce la pressione in modo uniforme durante la pedalata. Oltre a fissare i lacci, il Powerstrap sul collo del piede assicura una calzata stabile sostenendo l'arco plantare e bloccando il tallone.

Un modèle ergonomique à lacets qui enveloppe le pied et répartit la tension de manière homogène tout au long du coup de pédale. Le Powerstrap sur le cou-de-pied sécurise l'ajustement en stabilisant la voûte plantaire et en bloquant le talon en place tout en gardant les lacets sous contrôle.

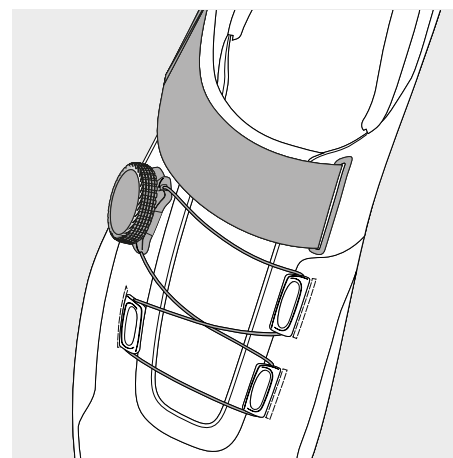

## STRAP + BOA

Sistema di chiusura doppio con strap in velcro e BOA. Lo strap sul collo del piede garantisce la massima stabilità e un sostegno ottimale, mentre il BOA® Fit System nell'avampiede assicura una calzata di precisione micro-regolabile.

Système de fermeture double avec une sangle velcro et un cadran BOA. Sur le cou-de-pied, une sangle permet de contenir le pied de manière exceptionnelle, tout en offrant un système infaillible. En outre, un système BOA® Fit est situé à l'avant-pied, assurant un ajustement d'une précision micro-ajustable.

# UPPER MATERIALS

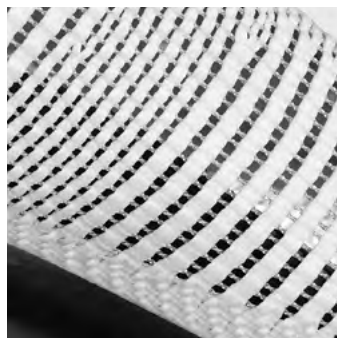

## AEROWEAVE

Un tessuto avanzato che intreccia fibre di leggero nylon con filamenti di polimero termoplastico. Questa miscela di fili crea un materiale con una struttura aperta, simile a una rete, estremamente areata, ma altamente resistente e resiliente. Aeroweave è un materiale malleabile: si muove per cullare adeguatamente il piede, ma la sua tenacia assicura il supporto e il contenimento necessari per una scarpa da gara ad alte prestazioni.

Un tissu à l'avant garde qui tisse des fibres de nylon légères avec des filaments de polymère thermoplastique. Ce mélange de fils crée un matériau à structure ouverte, semblable à un filet, extrêmement aéré, mais très résistant et élastique. Aeroweave est un matériau malléable: il bouge pour bien préserver le pied, mais sa tenue assure le maintien et le confinement nécessaires à une chaussure de course performante.



## KNIT

Tomaia realizzata con macchine per maglieria elettroniche che uniscono con precisione i cicli di filato sugli aghi e invertono senza soluzione di continuità la direzione del filato del tessuto creando diversi schemi di cucitura. Questo processo permette di produrre zone funzionali distinte, assegnando prestazioni specifiche ad aree chiave, come le feritoie di ventilazione e le aperture a maglia per una maggiore traspirabilità.

Tiges faites avec des machines à tricoter électroniques qui associent avec précision les cycles de fil sur les aiguilles et inversent de manière transparente la direction du fil de tissu créant différents motifs de couture. Ce processus permet de produire des zones fonctionnelles distinctes, en attribuant des performances spécifiques aux zones clés, telles que les fentes de ventilation et les ouvertures en filet pour une plus grande respirabilité.

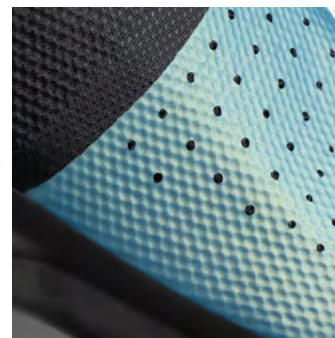

## PU LAMINATED

Tomaia in materiale resiliente laminato in poliuretano combinato con un comodo tessuto a rete, in grado di garantire una maggiore robustezza, un sostegno del piede duraturo e una migliore traspirabilità dove è più necessario.

La partie supérieure est composée d'un matériau laminé en polyuréthane résistant combiné à une maille confortable, ce qui permet de réduire le rendement et d'offrir un soutien durable du pied et une ventilation améliorée là où c'est le plus nécessaire.

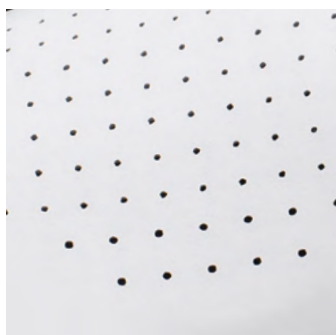

## MICROTEX

Tomaia in materiale sintetico simile alla vera pelle: flessibile e allo stesso tempo resistente, per una calzata confortevole e durevole nel tempo.

Tige en matière synthétique ayant les capacités du cuir véritable: flexible et en même temps résistant, pour un ajustement confortable et durable.



## RIPSTOP

Il Ripstop è un tessuto leggero e durevole con un'elevata resistenza a strappi e lacerazioni. La sua robustezza è dovuta all'inserimento di resistenti filati di rinforzo durante la tessitura, intrecciati a intervalli regolari.

Le Ripstop est un tissu tissé léger et résistant qui offre une haute résistance aux déchirures. Pendant le tissage, des fils de renfort plus résistants sont entrelacés à intervalles réguliers selon un motif hachuré pour réduire l'étalement des déchirures.

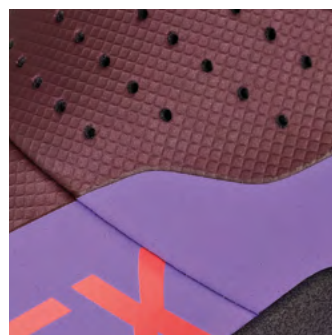

## GORETEX

La membrana GORE-TEX traspirante e impermeabile mantiene i piedi asciutti in qualsiasi condizione atmosferica, consentendo al sudore evaporato di fuoriuscire facilmente. Le nostre scarpe invernali sono dotate inoltre di una morbida fodera in pile, per calore e comfort anche nelle giornate fredde.

La membrane GORE-TEX respirante et imperméable garde les pieds au sec par tous les temps tout en permettant à la vapeur de la transpiration de s'échapper facilement. Dans nos chaussures d'hiver, une doublure en polaire broyée douce apporte chaleur et confort lors des sorties froides.



## 3D AIR MESH

Una tomaia in mesh altamente traspirante e morbida che aiuta a mantenere i piedi asciutti e a migliorare la traspirabilità.

Une construction de l'empeigne en mesh, très respirante et souple, permet de garder les pieds au sec et d'améliorer la ventilation.

# ROAD OUTSOLES

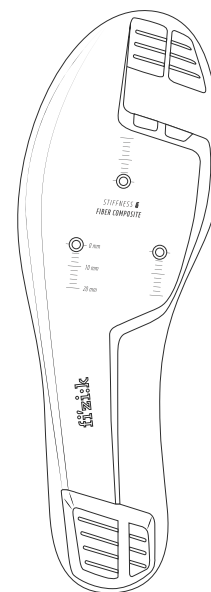
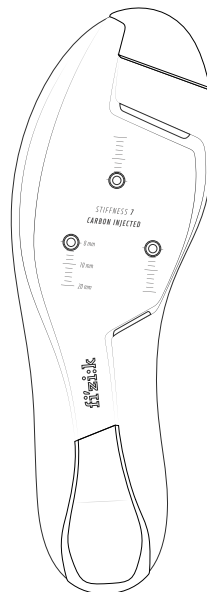
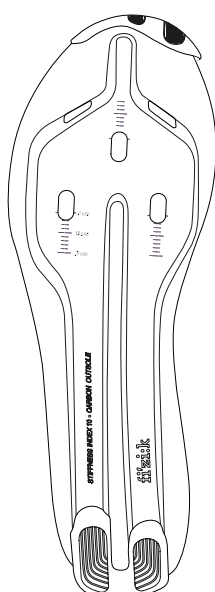
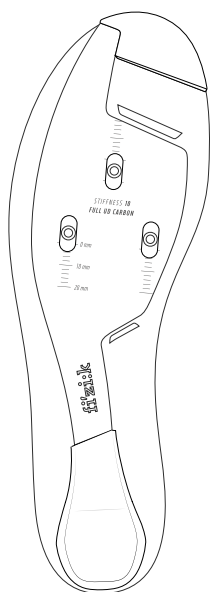

## R2

### INDICE DI RIGIDITÀ 10

Suola R2 in carbonio: posizionamento delle tacchette ottimizzato, alta rigidità e leggerezza finalizzate alla massima trasmissione di potenza.

### INDICE DE RIGIDITÉ 10

Semelle carbone R2: positionnement optimisé des fixations des cale-pédales, rigidité et légèreté élevées pour une transmission de puissance maximale.

## R3

### INDICE DI RIGIDITÀ 10

La soluzione definitiva in termini di rigidità e leggerezza. Una suola in carbonio per una posizione ottimizzata delle tacchette e progettata per il massimo trasferimento di potenza.

### INDICE DE RIGIDITÉ 10

L'ultime en matière de rigidité et de légèreté. Une semelle extérieure en carbone pour un positionnement optimisé des cales et un transfert de puissance maximal.

## R4

### INDICE DI RIGIDITÀ 7

Suola R4 in carbonio iniettato: moderatamente rigida per trasferire la potenza in modo confortevole.

### INDICE DE RIGIDITÉ 7

Semelle en carbone injecté R4: moyennement rigide pour transférer la puissance en tout confort.

## R5

### INDICE DI RIGIDITÀ 6

Suola R5 in nylon e composito: bilancia comfort ed efficienza nella pedalata.

### INDICE DE RIGIDITÉ 6

Semelle en nylon et composite R5: équilibre confort et efficacité lors du pédalage.



# OFF-ROAD OUTSOLES

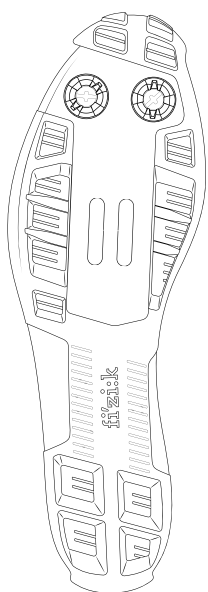

## X1

### INDICE DI RIGIDITÀ 10

Suola UD in carbonio, un'interfaccia con rigidità per la competizione, con durevole battistrada in TPU. Utilizzo indicato: Cross-Country, Ciclocross.

### INDICE DE RIGIDITÉ 10

Semelle en carbone UD, une interface avec rigidité pour la compétition, avec semelle externe en TPU durable. Utilisation indiquée : VTT, Cyclocross.

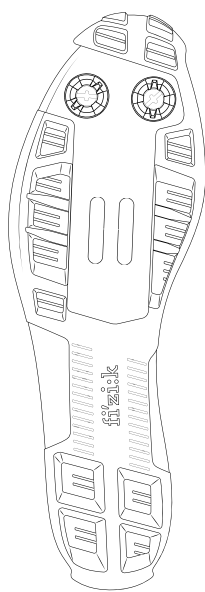

## X3

### INDICE DI RIGIDITÀ 8

Materiale in fibra composita per garantire elevata rigidità e un efficiente trasferimento di potenza, con una suola in gomma per il comfort. Utilizzo indicato: XC, CX, Gravel.

### INDICE DE RIGIDITÉ 8

Fibre composite pour une haute rigidité et un transfert de puissance efficace avec une semelle extérieure en caoutchouc pour le confort. Utilisation indiquée : XC, CX, Gravel.

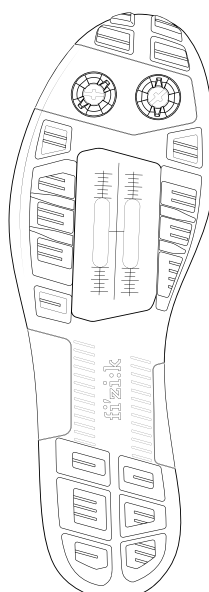

## X5

### INDICE DI RIGIDITÀ 5

Nylon rinforzato con un durevole battistrada in TPU. Utilizzo indicato: Cross Country, Ciclocross, Gravel Bike.

### INDICE DE RIGIDITÉ 5

Nylon renforcé avec semelle externe en TPU durable. Utilisation indiquée : VTT, Cyclocross, Gravel.

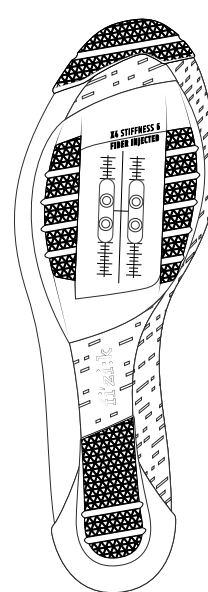

## X4

### INDICE DI RIGIDITÀ 6

Rigidità calibrata e gomma del battistrada adatta per le superfici miste. Utilizzo indicato: Gravel.

### INDICE DE RIGIDITÉ 6

Rigidité calibrée et caoutchouc de semelle externe adapté aux surfaces mixtes. Utilisation appropriée : Gravel.

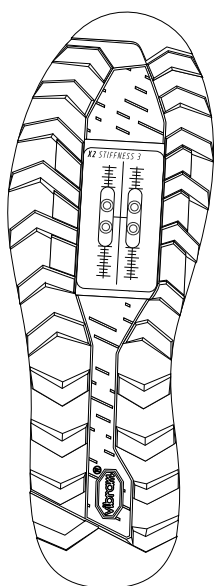

## X2

### INDICE DI RIGIDITÀ 3

Battistrada in Vibram per la trazione sui pedali e a piedi. Utilizzo indicato: Trail.

### INDICE DE RIGIDITÉ 3

Semelle externe Vibram pour la traction en pédalant et pour les parties pédestres. Utilisation appropriée : Trail.

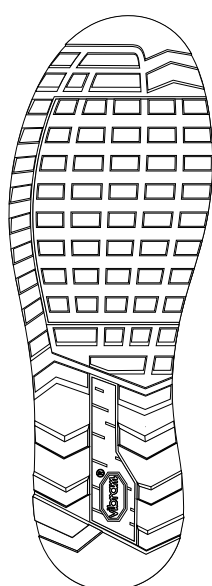

## X2 FLAT

### INDICE DI RIGIDITÀ 2

La miscela Vibram Megagrip combinata con il design del battistrada Fizik assicura un grip eccellente sui pedali flat e massima trazione anche durante la camminata. Utilizzo indicato: All-Mountain, Gravel, Bikepacking.

### INDICE DE RIGIDITÉ 2

Le composé Vibram Megagrip combiné au design de la semelle fizik assure l'adhérence sur les pédales plates et une bonne traction en dehors du vélo. Utilisation indiquée : All-Mountain, Gravel, Bikepacking.

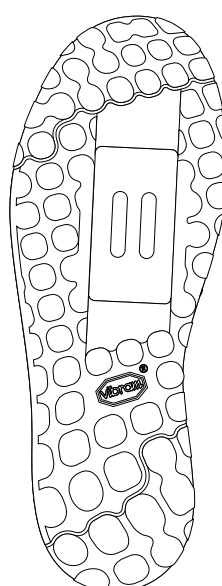

## X6

### INDICE DI RIGIDITÀ 5

La miscela e il design dei tasselli di Vibram® XS Trek EVO sono studiati per favorire il grip sui pedali e il massimo controllo della bicicletta per una guida gravity veloce e aggressiva. La guida per le tacchette estesa della versione clip-in consente un posizionamento delle tacchette più arretrato, per ottenere una migliore stabilità e un maggiore controllo in discesa grazie a una posizione del tallone più ribassata. Utilizzo indicato: DH-Enduro.

### INDICE DE RIGIDITÉ 5

Le composé et le motif des crampons Vibram® XS Trek EVO sont conçus pour l'adhérence des pédales et le contrôle du vélo lors des sorties rapides et agressives en descente. Dotée d'une piste de crampons allongée, la version pour pédales automatiques vous permet de placer vos cales plus en arrière pour permettre de laisser tomber les talons dans les descentes, améliorant ainsi la stabilité et le contrôle. Utilisation indiquée : DH-Enduro.

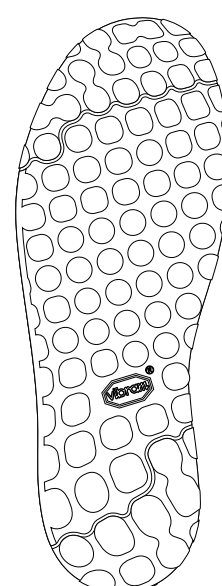

## X6 FLAT

### INDICE DI RIGIDITÀ 2

La miscela Vibram Megagrip e il design dei tasselli sono studiati per favorire il grip sui pedali e il massimo controllo della bicicletta per una guida gravity veloce e aggressiva. Utilizzo indicato: DH-Enduro.

### INDICE DE RIGIDITÉ 2

Le composé Vibram Megagrip et le motif des crampons sont conçus pour assurer l'adhérence des pédales et le contrôle du vélo lors des sorties rapides et agressives en descente. Utilisation indiquée : DH-Enduro.

# ROAD AND TRIATHLON SHOES







VENTO INFINITO KNIT CARBON 2 è una performante scarpa stradale da competizione sviluppata con una nuova ed evoluta tomaia con struttura a maglia, per una maggiore traspirabilità.

VENTO INFINITO KNIT CARBON 2 est une chaussure de cyclisme de course sur route haute performance conçue avec une nouvelle tige tissu maille "knit" pour une meilleure respirabilité.

## VENTO INFINITO KNIT CARBON 2

Intended use: ROAD RACING

Weight: 225g

Infinito: controllo ottimizzato del volume nell'area dell'avampiede

Volume Control: regolazione indipendente sul collo del piede e sull'avampiede

Tomaia Knitted: costruzione superventilata, con un supporto in TPU termosaldato

Suola R2 in fibra di carbonio: posizionamento ottimizzato delle tacchette, elevata rigidità e leggerezza ottimizzate per il trasferimento della potenza

Infinito : contrôle précis du volume de la zone de l'avant-pied

Volume Control : ajustement indépendant de l'ajustement pour le cou-de-pied et l'avant-pied

Tige tissu maille knit : construction extrêmement ventilée avec fil TPU thermofusible de soutien

Semelle externe en fibre de carbone R2 : positionnement optimisé des fixation des cales, rigidité et légèreté élevées pour un transfert de puissance maximal



ARTICLE	EAN	MODEL	COLOR	SIZE	OUTSOLE	CLOSURE	UPPER	SRP (€)
VER2IKR1C1010	Various	<b>Vento Infinito Knit</b>	Black/Black	36-48*	Full Carbon	2x BOA Li2 B dials	Knitted	380
VER2IKR1C9610	Various	<b>Carbon 2</b>	Coral/Black		Unidirectional			380

Tutti i modelli sono disponibili nelle taglie piene | Tous les modèles sont disponibles en tailles pleines

(\*) Modello disponibile anche nelle taglie: **42½, 43½, 44½** | Egalement disponible dans les tailles: **42½, 43½, 44½**



VENTO INFINITO CARBON 2 è la versione più aggiornata della nostra leggendaria scarpa stradistica da competizione, sviluppata e scelta assieme ai migliori atleti del ciclismo professionistico.

VENTO INFINITO CARBON 2 est le dernier degré d'extrême perfection de notre légendaire chaussure de cyclisme de course sur route haute performance, développée avec et choisie par des athlètes de premier plan du peloton professionnel.

## VENTO INFINITO CARBON 2

Intended use: ROAD RACING

Weight: 227g

Infinito: controllo ottimizzato del volume nell'area dell'avampiede  
 Volume Control: regolazione indipendente sul collo del piede e sull'avampiede  
 Tomaia in Microtex: morbida ma resistente e durevole, per una calzata comoda e durevole  
 Suola R2 in fibra di carbonio: posizionamento ottimizzato delle tacchette, elevata rigidità e leggerezza ottimizzate per il trasferimento della potenza

Infinito : contrôle précis du volume de la zone de l'avant-pied  
 Volume Control : ajustement indépendant de l'ajustement pour le cou de pied et l'avant-pied  
 Tige Microtex : souple mais solide et durable pour un ajustement confortable et précis  
 Semelle externe en fibre de carbone R2 : positionnement optimisé des fixation des cales pour un transfert de puissance maximal



ARTICLE	EAN	MODEL	COLOR	SIZE	OUTSOLE	CLOSURE	UPPER	SRP (€)
VER2IXR1C1010	Various	<b>Vento Infinito Carbon 2</b>	Black/Black	36-48*	Full Carbon Unidirectional	2x BOA Li2 B dials	Microtex	380
VER2IXR1C2010	Various		White/Black					380
VER2IXR1C7096	Various		Grey/Coral**					380

Tutti i modelli sono disponibili nelle taglie piene | Tous les modèles sont disponibles en tailles pleines

(\*) Modello disponibile anche nelle taglie: **42½, 43½, 44½** | Egalement disponible dans les tailles: **42½, 43½, 44½**

(\*\*) Fino ad esaurimento scorte | Jusqu'à épuisement des stocks



VENTO POWERSTRAP AEROWEAVE. L'innovativa tomaia di seconda generazione Aeroweave rende Powerstrap Aeroweave una scarpa da corsa senza compromessi. La più leggera e traspirante della gamma, è costruita con una struttura a rete ad elevata resistenza abbinata alla nostra suola in carbonio più rigida.

VENTO POWERSTRAP AEROWEAVE. La tige innovante Aeroweave de deuxième génération fait de la Powerstrap Aeroweave une chaussure de course à part entière. La plus légère et la plus respirante de la gamme, construite avec une structure de filet à haute résistance associée à notre semelle extérieure en carbone la plus rigide.

## VENTO POWERSTRAP AEROWEAVE CARBON

Intended use: ROAD RACING

Weight: 184g

Aeroweave: struttura a rete estremamente traspirante e ad alta tenacità

Powerstrap: chiusura a strappo progettata per una calzata avvolgente

Suola R3 in carbonio: posizionamento ottimizzato delle tacchette, rigidità e leggerezza per una massima trasmissione di potenza

Aeroweave : structure extrêmement respirante, en forme de filet à haute résistance

Powerstrap : fermeture velcro enrobant le pied, conçue pour un ajustement enveloppant

Semelle R3 en carbone : positionnement optimisé des cales, rigidité et légèreté ultimes pour un transfert de puissance maximal



ARTICLE	EAN	NEW	MODEL	COLOR	SIZE	OUTSOLE	CLOSURE	UPPER	SRP (€)
VER3PAR1C2020	Various	<b>NEW</b>	<b>Vento Powerstrap</b>	White/White	36-48*	Full Carbon	Powerstrap	Aeroweave	350
VER3PAR1C9631	Various	<b>NEW</b>	<b>Aeroweave Carbon</b>	Coral/Orange	36-48*				

Tutti i modelli sono disponibili nelle taglie piene | Tous les modèles sont disponibles en tailles pleines

(\*) Modello disponibile anche nelle taglie: **42½, 43½, 44½** | Egalement disponible dans les tailles: **42½, 43½, 44½**



TEMPO DECOS è stata progettata per collocarsi nel punto dove si incontrano comfort e prestazioni, è una scarpa essenziale che unisce un singolo rotore BOA minimalistico sulla tomaia con una rigida suola in carbonio per andare lontano.

TEMPO DECOS est conçue pour représenter le compromis idéal confort/performance, c'est une chaussure réunissant tige très simple et une unique molette de serrage BOA avec une semelle rigide en carbone pour tenir la distance.

## TEMPO DECOS CARBON

Intended use: ROAD RACING

Weight: 205g

Tomaia in rete laminata PU: aerazione migliorata, supporto dove questo è necessario  
Suola R2 in fibra di carbonio: posizionamento ottimizzato delle tacchette, elevata rigidità e leggerezza ottimizzate per il trasferimento della potenza

Tige en maille laminée PU : ventilation améliorée avec soutien là où c'est le plus nécessaire  
R2 Semelle en fibre de carbone : positionnement optimisé des fixation des cales pédales, rigidité élevée et légèreté optimisées pour le transfert de puissance



## TEMPO DECOS CARBON WIDE

Calzata larga: fornisce più spazio sull'avampiede, sviluppando un volume maggiore e più spazio al metatarso

Fit large: offre plus d'espace sur l'avant-pied, développant un plus grand volume et plus d'espace dans le métatarsien



ARTICLE	EAN	MODEL	COLOR	SIZE	OUTSOLE	CLOSURE	UPPER	SRP (€)
TPR2BMR1C3610	Various		Aubergine					290
TPR2BMR1C1010	Various	<b>Tempo Decos Carbon</b>	Black/Black	36-48*	Full Carbon Unidirectional	Li2 BOA® Fit System	PU Laminate Over Mesh	290
TPR2BMR1C2020	Various		White/White					290
TPR2BMR1C9910	Various		Iridescent Blue					290
TPR2BMW1C2020	Various	<b>Tempo Decos Wide</b>	White/White	36-48*	Full Carbon Unidirectional	Li2 BOA® Fit System	PU Laminate Over Mesh	290

Tutti i modelli sono disponibili nelle taglie piene | Tous les modèles sont disponibles en tailles pleines

(\*) Modello disponibile anche nelle taglie: **42½, 43½, 44½** | Egalement disponible dans les tailles: **42½, 43½, 44½**







VENTO OMNA è una scarpa da ciclismo su strada reattiva e sviluppata per i ciclisti agonisti che cercano caratteristiche e prestazioni pronte per la gara.

Réactive, la VENTO OMNA est une pure chaussure de cyclisme sur route, conçue pour les coureurs qui recherchent des caractéristiques et des performances adaptées à la compétition.

## VENTO OMNA

Intended use: ROAD

Weight: 238g

Suola in nylon R5: posizionamento ottimizzato delle tacchette con un indice di rigidità moderato  
 Tomaia in PU: un materiale resistente e leggero che rende la scarpa confortevole e durevole al tempo stesso  
 Pronta per gareggiare: calzata performante, regolabile tramite una singola chiusura BOA® bidirezionale

Semelle extérieure en nylon R5 : Positionnement optimisé des crampons avec un indice de rigidité modéré  
 Tige en PU : Un revêtement résistant et léger qui rend la chaussure confortable tout en conservant sa durabilité  
 Prête pour la course : Un ajustement performant, réglable grâce à une molette BOA® bidirectionnelle unique



## VENTO OMNA WIDE NEW

Calzata larga: fornisce più spazio sull'avampiede, sviluppando un volume maggiore e più spazio al metatarso

Fit large: offre plus d'espace sur l'avant-pied, développant un plus grand volume et plus d'espace dans le métatarsien



ARTICLE	EAN	NEW	MODEL	COLOR	SIZE	OUTSOLE	CLOSURE	UPPER	SRP (€)
VER5BPR1K1010	Various			Black/Black	36-48*				165
VER5BPR1K2010	Various			White/Black	36-48				165
VER5BPR1K3010	Various		<b>Vento Omna</b>	Red/Black	36-48	R5 nylon	1x BOA Li2 Dial C Fit System	PU	165
VER5BPR1K7510	Various			Metallic Gun Metal/Black	36-48				165
VER5BPR1K3A10	Various			Cherry/Black	36-48				165
VER5BPW1K2010	Various	<b>NEW</b>	<b>Vento Omna Wide</b>	White/Black	36-48	R5 nylon	1x BOA Li2 Dial C Fit System	PU	165

Tutti i modelli sono disponibili nelle taglie piene | Tous les modèles sont disponibles en tailles pleines

(\*) Modello disponibile anche nelle taglie: **42½, 43½, 44½** | Egalement disponible dans les tailles: **42½, 43½, 44½**



TEMPO OVERCURVE R4, una scarpa da ciclismo su strada polivalente disegnata per adattarsi alle uscite individuali o a quelle di gruppo del fine settimana, per l'allenamento quotidiano o per sfruttarle in occasione di una granfondo.

TEMPO OVERCURVE R4, une chaussure de cyclisme sur route polyvalente conçue pour s'adapter aux sorties individuelles ou en groupe le week-end, pour un entraînement quotidien ou pour en profiter lors d'une épreuve cyclo-sportive.

## TEMPO OVERCURVE R4

Intended use: ROAD

Weight: 230g

Overcurve: costruzione asimmetrica che si adegua ergonomicamente all'anatomia del piede  
Tomaia in rete laminata in PU: aerazione migliorata, supporto dove questo è necessario  
Suola R4 in carbonio iniettato: moderatamente rigida per un trasferimento di potenza ottimale nel rispetto del comfort

Overcurve : construction asymétrique qui s'adapte ergonomiquement à l'anatomie du pied  
Tige en mesh laminé PU : aération améliorée, avec un support là où cela est nécessaire  
R4 Semelle en carbone injecté : moyennement rigide pour un transfert de puissance optimal tout en respectant le confort



## TEMPO OVERCURVE R4 WIDE

Calzata larga: fornisce più spazio sull'avampiede, sviluppando un volume maggiore e più spazio al metatarso

Fit large: offre plus d'espace sur l'avant-pied, développant un plus grand volume et plus d'espace dans le métatarsien



ARTICLE	EAN	MODEL	COLOR	SIZE	OUTSOLE	CLOSURE	UPPER	SRP (€)
TPR4OXR1K1010	Various	<b>Tempo Overcurve R4</b>	Black/Black	36-48	Carbon Injected Nylon	1x BOA IP1-B dial	Pu Laminated Mesh	219
TPR4OXR1K2010	Various		White/Black					219
TPR4OXR1K4210	Various		Navy/Black					219
TPR4OIR1K8310	Various		Copper/Black Iridescent					219
TPR4OIR1K8410	Various		Beetle/Black Iridescent					219
TPR4OXW1K1010	Various	<b>Tempo Overcurve R4 Wide</b>	Black/Black	36-48	Carbon Injected Nylon	1x BOA IP1-B dial	Pu Laminated Mesh	219



TEMPO OVERCURVE R5 è una scarpa da ciclismo con calzata veloce che si adatta a ogni ciclista ed ogni tipo di uscita.

TEMPO OVERCURVE R5 est une chaussure de cyclisme avec un ajustement rapide qui s'adapte à chaque cycliste et à chaque style de pratique.

## TEMPO OVERCURVE R5

Intended use: ROAD

Weight: 246g

Overcurve: costruzione asimmetrica che si adegua ergonomicamente all'anatomia del piede  
 Tomaia in Microtex: morbida ma resistente e duratura per una calzata confortevole e durevole nel tempo  
 Suola R5 in nylon e composito: permette di bilanciare comfort ed efficienza nella pedalata

Overcurve : construction asymétrique qui s'adapte de manière ergonomique à l'anatomie du pied  
 Empeigne en Microtex : douce mais résistante et durable pour un ajustement confortable et durable  
 Semelle en nylon et composite R5 : permet d'équilibrer confort et efficacité de pédalage



ARTICLE	EAN	MODEL	COLOR	SIZE	OUTSOLE	CLOSURE	UPPER	SRP (€)
TPR50CMI21010	Various	<b>Tempo Overcurve R5</b>	Black/Black**	36-48*				119
TPR50CMI22010	Various		White/Black**	36-48	Carbon			119
TPR50CMI21092	Various		Black/Pink Fluo**	36-42	Reinforced	1x BOA IP1-B dial + front Velcro	Microtex	119
TPR50CMI21090	Various		Black/Yellow Fluo**	38-48	Nylon			119
TPR50CMI27510	Various		Metallic Gun Metal/Black**	36-48				119

Tutti i modelli sono disponibili nelle taglie piene | Tous les modèles sont disponibles en tailles pleines

(\*) Modello disponibile anche nelle taglie: **42½, 43½, 44½** | Egalement disponible dans les tailles: **42½, 43½, 44½**

(\*\*) Fino ad esaurimento scorte | Jusqu'à épuisement des stocks



TEMPO POWERSTRAP R5 è una versatile scarpa da ciclismo su strada con un'innovativa chiusura Velcro disegnata per una calzata avvolgente.

TEMPO POWERSTRAP R5 est une chaussure de cyclisme sur route polyvalente avec une fermeture Velcro innovante conçue pour un ajustement parfait.

## TEMPO POWERSTRAP R5

Intended use: ROAD

Weight: 255g

Powerstrap: chiusura con Velcro che avvolge il piede  
Disegnata per una calzata avvolgente  
Suola R5 in nylon e composito: permette di bilanciare comfort ed efficienza nella pedalata

Powerstrap : fermeture velcro qui enveloppe le pied.  
Conçu pour un ajustement enveloppant  
R5 Semelle en nylon et composite : permet d'équilibrer confort et efficacité lors du pédalage



ARTICLE	EAN	MODEL	COLOR	SIZE	OUTSOLE	CLOSURE	UPPER	SRP (€)
TPR5PSPU21010	Various	<b>Tempo Powerstrap R5</b>	Black/Black	36-48	Carbon Reinforced Nylon	Foot-wrapping Velcro	PU	139
TPR5PSPU22010	Various		White/Black					139
TPR5PSRE17410	Various		Reflective Grey/Black					149



TEMPO ARTICA R5 GTX è la nostra scarpa invernale specifica per il ciclismo su strada. La fodera in pile garantisce calore e isolamento, mentre l'avanzata membrana GORE-TEX offre traspirabilità e impermeabilità.

La TEMPO ARTICA R5 GTX est notre chaussure d'hiver spécifique à la route, isolée avec une doublure molletonnée pour plus de chaleur, respirante et imperméable grâce à une membrane GORE-TEX avancée.

## TEMPO ARTICA R5 GTX

Intended use: ROAD

Weight: 319g

Membrana Gore-Tex Koala: isolata, impermeabile e traspirante, la membrana Koala di GORE-TEX ti mantiene caldo e asciutto durante le rigide giornate invernali

Fodera in pile: la morbida fodera in pile spazzolato aggiunge isolamento e comfort alle tue uscite anche nei giorni più freddi

Comfort per tutto il giorno: vestibilità generosa e regolazioni facili grazie al pratico BOA® Fit System a rotella singola e allo strap in velcro

Membrane Gore-Tex Koala : isolante, imperméable et respirante, la membrane Koala de GORE-TEX vous garde au chaud et au sec dans les conditions de sortie hivernales les plus difficiles

Doublure molletonnée : La doublure douce en polaire brossée ajoute de l'isolation et du confort lors des sorties hivernales les plus froides

Confort tout au long de la journée : La coupe généreuse et les ajustements faciles sont fournis par un système d'ajustement pratique à cadran unique BOA® et une sangle sécurisée en velcro



ARTICLE	EAN	MODEL	COLOR	SIZE	OUTSOLE	CLOSURE	UPPER	SRP (€)
TPR5AGR1V1010	Various	<b>Tempo Artica R5 GTX</b>	Black/Black	40-48	R5 nylon	1x BOA L6 dial & ankle Velcro strap	High-density PU upper + Ripstop fabric	259
TPR5AGR1V2070	Various		White/Grey					259



TRANSIRO HYDRA AEROWAVE una scarpa racing da triathlon che combina un'innovativa tomaia Aeroweave di seconda generazione con una suola rigida in carbonio per una pedalata efficiente e transizioni più veloci e senza preoccupazioni.

TRANSIRO HYDRA AEROWAVE une pure chaussure de triathlon qui associe une tige Aeroweave innovante de deuxième génération avec une semelle extérieure rigide en carbone pour un pédalage efficace et des transitions plus rapides et sans souci.

## TRANSIRO HYDRA AEROWEAVE CARBON

Intended use: TRIATHLON

Weight: 225g

Aeroweave: struttura a rete estremamente traspirante e robusta

Strap in velcro sul collo del piede per transizioni rapide

Suola R2: interamente in carbonio - indice di rigidità 10

Aeroweave : structure en forme de maille extrêmement respirante et à haute ténacité.

Bande velcro sur le cou-de-pied pour une transition rapide

Semelle extérieure R2 : entièrement en carbone, indice de rigidité 10



ARTICLE	EAN	MODEL	COLOR	SIZE	OUTSOLE	CLOSURE	UPPER	SRP (€)
TRR2PAR1K2080	Various	<b>Transiro Hydra Aeroweave Carbon</b>	White/Silver	36-48*	Full carbon unidirectional	Instep velcro strap	Aeroweave	290
TRR2PAR1K20RB	Various		White/Red-Blue					290

Tutti i modelli sono disponibili nelle taglie piene | Tous les modèles sont disponibles en tailles pleines

(\*) Modello disponibile anche nelle taglie: **42½, 43½, 44½** | Egalement disponible dans les tailles: **42½, 43½, 44½**



TRANSIRO HYDRA una scarpa da triathlon progettata per facilitare le transizioni, costruita con una tomaia traspirante e una suola in nylon moderatamente rigida che combina comfort ed efficienza di pedalata.

TRANSIRO HYDRA une chaussure de triathlon conçue pour faciliter les transitions, construite avec une tige respirante et une semelle extérieure en nylon modérément rigide qui associe confort et efficacité de pédalage.

## TRANSIRO HYDRA

Intended use: TRIATHLON

Weight: 233g

3D Air mesh: tomaia estremamente traspirante e leggera  
Strap in velcro sul collo del piede per transizioni rapide  
Nuova suola in nylon R5 - indice di rigidità 6

Maille 3D Air : tige extrêmement respirante et légère  
Bande velcro sur le cou-de-pied pour une transition rapide  
Nouvelle semelle extérieure en nylon R5 - indice de rigidité 6



ARTICLE	EAN	MODEL	COLOR	SIZE	OUTSOLE	CLOSURE	UPPER	SRP (€)
TRR5PMR1K2010	Various	<b>Transiro Hydra</b>	White/Black	36-48	R5 nylon	Instep velcro strap	3D Air mesh	149
TRR5PMR1K20MR	Various		White/Metallic Red					149
TRR5PMR1K20MB	Various		White/Metallic Blue					149



# OFF-ROAD SHOES







VENTO FEROX è una scarpa progettata per il fuoristrada agonistico, il cross-country e il gravel, unisce una suola in carbonio pronta alla competizione con una tomaia costruita in modo traspirante, leggera e anche durevole e resistente.

VENTO FEROX est une chaussure conçue pour les compétition tout-terrain le cross country et le gravel, réunissant une semelle carbone adaptée à la performance avec une partie supérieure respirante et légère mais durable et résistante.

## VENTO FEROX CARBON

Intended use: CROSS-COUNTRY / GRAVEL RACING

Weight: 300g

Tomaia in rete laminata PU: leggera e traspirante con una costruzione a prova di strappo

Powerstrap & Boa Fit System: doppio sistema di chiusura dove il collo e la pianta del piede sono regolabili separatamente per una calzata personalizzata e sicura

Suola X1 in carbonio & Gomma: suola full carbon, elevata rigidità e leggerezza calibrate per il trasferimento di potenza e una trazione eccellente quando si è a piedi

Tige en maille laminée PU : légère et respirante donnant une construction indéchirable

Powerstrap & Boa Fit System : système de double fermeture où le cou-de-pied et le milieu du pied sont réglables séparément permettant un ajustement personnalisé et sécurisé

Semelle extérieure en carbone et caoutchouc X1 : semelle entièrement en carbone, haute rigidité et légèreté pour un transfert de puissance et une excellente traction à pied



ARTICLE	EAN	MODEL	COLOR	SIZE	OUTSOLE	CLOSURE	UPPER	SRP (€)
VEX1WMR1C1010	Various	<b>Vento</b>	Black/Black	36-48	Full Carbon Unidirectional, Rubber Treads	Li2 BOA® Fit System + Velcro Strap	PU Laminated Mesh	299
VEX1WMR1C3820	Various	<b>Ferox</b>	Lilac/White					299



VENTO PROXY è una scarpa off-road sviluppata per ciclisti competitivi che cercano caratteristiche pensate per le gare e un efficiente trasferimento di potenza su strade sterrate.

La VENTO PROXY est une chaussure de course tout-terrain développée pour les coureurs qui recherchent des caractéristiques pour la compétition et un transfert de puissance efficace sur les routes non goudronnées.

**VENTO**  
**PROXY** NEW

Intended use: XC, CX, GRAVEL

Weight: 325g

Tomaia in rete laminata in PU: leggera e traspirante con una costruzione antistrappo  
Pratico sistema di chiusura singola BOA  
Suola in fibra composita X3 e gomma: elevata rigidità per un efficiente trasferimento di potenza e comfort

Empeigne en PU laminé : légère et respirante dans une construction résistante à la déchirure  
Système de fermeture BOA simple pratique  
Semelle extérieure en composite X3 Fiber et caoutchouc : grande rigidité pour un transfert de puissance efficace et confortable



ARTICLE	EAN	NEW	MODEL	COLOR	SIZE	OUTSOLE	CLOSURE	UPPER	SRP (€)
VEX3BPR1V1010	Various	<b>NEW</b>		Black/Black	36-48*				229
VEX3BPR1V9635	Various	<b>NEW</b>	<b>Vento Proxy</b>	Coral/Purple	36-48*	X3 Fiber composite and rubber outsole	BOA Li2	PU Laminated Mesh	229
VEX3BPR1V2020	Various	<b>NEW</b>		White/White	36-48*				229

Tutti i modelli sono disponibili nelle taglie piene | Tous les modèles sont disponibles en tailles pleines

(\*) Modello disponibile anche nelle taglie: **42½, 43½, 44½** | Egalement disponible dans les tailles: **42½, 43½, 44½**



TERRA ATLAS la nostra versatile e affidabile all-terrain, per il gravel su tutti i tipi di percorso, per il mountain biking e anche oltre.

TERRA ATLAS notre modèle tout-terrain polyvalent et fiable, pour le gravel, le VTT et bien plus encore.

## TERRA ATLAS

Intended use: CROSS-COUNTRY / GRAVEL /  
DOWN-COUNTRY

Weight: 355g

Per tutti i terreni e tutte le situazioni: si adattano a una vasta gamma di stili di guida, dall' all-mountain al cross country e al gravel.  
Comfort per tutto il giorno: vestibilità generosa, con un pratico sistema di chiusura con singolo rotore BOA  
Suola X5 in nylon e gomma: assicura efficienza di pedalata assieme a una trazione in fuoristrada affidabile e sicura

Le All-Terrain, All-Rounder : convient à un large éventail de styles de pratique, du tout terrain au crosscountry et à la rando Gravel : avec un système de fermeture Boa, simple et pratique  
Semelle extérieure en nylon et caoutchouc X5 offre une efficacité de pédalage ainsi qu'une traction tout-terrain rassurant et sûre



LIMITED EDITION

LIMITED EDITION



ARTICLE	EAN	MODEL	COLOR	SIZE	OUTSOLE	CLOSURE	UPPER	SRP (€)
TEX5BPR1K7010	Various		Grey/Black					159
TEX5BPR1K1010	Various		Black/Black					159
TEX5BPR1K6110	Various	<b>Terra Atlas</b>	Army	36-48	Nylon, Rubber Treads	L6 BOA® Fit System	Tear Resistant High Density PU	159
TEX5BPR1K3710	Various		Pink Grape					159
TEX5BPR1K1033	Various		Black/Splash Purple					159
TEX5BPR1K5039	Various		Green/Splash Pink					159



VENTO OVERCURVE X3 è una scarpa da cross-country racing disegnata e creata per sfruttare al meglio le sue funzioni chiave: calzare perfettamente, proteggerti e trasferire efficientemente i watt mentre si è impegnati sui circuiti di gara.

VENTO OVERCURVE X3 est une chaussure de compétition VTT conçue et créée pour tirer le meilleur parti de ses fonctions clés: s'adapter parfaitement, se protéger et transférer efficacement les watts sur les course les plus éprouvantes.

## VENTO OVERCURVE X3

Intended use: CROSS-COUNTRY

Weight: 299g

Overcurve: costruzione asimmetrica che si adatta ergonomicamente all'anatomia del piede  
Tomaia in Microtex: morbida ma resistente e duratura, per una calzata confortevole e durevole nel tempo  
Suola X3: una rigida interfaccia per la competizione in carbonio iniettato, con durevole battistrada in TPU

Overcurve : construction asymétrique qui s'adapte ergonomiquement à l'anatomie du pied  
Tige Microtex : douce mais résistante et durable, pour un ajustement confortable et ferme  
Semelle X3 : une interface rigide pour la compétition en carbone injecté, avec une semelle externe en TPU durable



ARTICLE	EAN	MODEL	COLOR	SIZE	OUTSOLE	CLOSURE	UPPER	SRP (€)
VEX3OCMI11010	Various	<b>Vento</b>	Black/Black**	36-48*	Carbon Injected Nylon, TPU Studs	1x BOA IP1-B dial	Microtex	229
VEX3OCMI12010	Various	<b>Overcurve X3</b>	White/Black**					229

Tutti i modelli sono disponibili nelle taglie piene | Tous les modèles sont disponibles en tailles pleines

(\*) Modello disponibile anche nelle taglie: **42½, 43½, 44½** | Egalement disponible dans les tailles: **42½, 43½, 44½**

(\*\*) Fino ad esaurimento scorte | Jusqu'à épuisement des stocks





TERRA POWERSTRAP X4 è una scarpa versatile e polivalente ideale per il gravel biking: è perfetta per quei rider che le loro avventure le cercano ben oltre i classici percorsi asfaltati.

TERRA POWERSTRAP X4 est une chaussure polyvalente idéale pour la pratique du gravel: elle est parfaite pour les cyclistes qui recherchent l'aventure bien au-delà des routes goudronnées.

**TERRA**  
**POWERSTRAP X4**

Intended use: GRAVEL

Weight: 292g

Powerstrap: chiusura con avvolgimento del piede con Velcro progettata per una vestibilità avvolgente  
Suola X4: rigidità calibrata e gomma del battistrada adatta per le superfici miste

Powerstrap : fermeture enveloppante du pied par velcro conçue pour un ajustement parfait  
Semelle X4 : rigidité calibrée et caoutchouc de semelle externe adapté aux surfaces mixtes



ARTICLE	EAN	MODEL	COLOR	SIZE	OUTSOLE	CLOSURE	UPPER	SRP (€)
TEX4PPR1K8586	Various	<b>Terra</b>	Mud/Caramel	36-48	Fiber Reinforced Nylon,	Foot-wrapping	PU	159
TEX4PPR1K1010	Various	<b>Powerstrap X4</b>	Black/Black		Rubber Tread	Velcro		159





TERRA CLIMA X2 è una scarpa da all-mountain resistente alle intemperie e traspirante che non si tirerà indietro quando le condizioni di guida si faranno ostiche.

TERRA CLIMA X2 est une chaussure tout terrain résistante aux intempéries et respirante qui sera à hauteur de vos attentes dans les conditions les moins favorables et les plus extrêmes.

## TERRA CLIMA X2

Intended use: ALL-MOUNTAIN

Weight: 414g

Clima: tomaia traspirante e a prova di intemperie  
 Tessuto Ripstop: tessuto resistente allo strappo e alla lacerazione  
 Ghetta integrata in maglia per impedire l'ingresso di detriti  
 Suola X2: in gomma Vibram per la trazione sui pedali e a piedi

Clima : Tige respirante et résistante aux intempéries  
 Tissu Ripstop : tissu résistant à l'abrasion et à la déchirure  
 Chausson tricotée intégrée : empêche la poussière et la saleté d'entrer  
 Semelle X2 : caoutchouc Vibram pour la traction sur les pédales et dans les parties pédestres



ARTICLE	EAN	MODEL	COLOR	SIZE	OUTSOLE	CLOSURE	UPPER	SRP (€)
TEX2CLTX11010	Various	<b>Terra Clima X2</b>	Black/Black**	36-48	Nylon Shank, EVA Midsole, Vibram Megagrip Tread	Instep Velcro + 1x BOA L6 dial	Ripstop Fabric with Waterproof/Breathable Membrane	250

(\*\*) Fino ad esaurimento scorte | Jusqu'à épuisement des stocks



TERRA ERGOLACE X2 è una scarpa da mountain bike robusta, adattabile, con i lacci, fedele alle radici del fuoristrada: potrai affrontarci ogni tipo di terreno, andarci tranquillamente su e giù per i trail, in sella oppure a piedi.

TERRA ERGOLACE X2 est une chaussure VTT robuste, adaptable, à lacets, fidèle aux racines du vélo tout-terrain: vous pouvez affronter tout type de terrain, monter et descendre les sentiers, à vélo ou à pied.

**TERRA**  
**ERGOLACE X2**

Intended use: TRAIL, GRAVEL, BIKE PACKING

Weight: 329g

Ergolace: chiusura a lacci ergonomica per una calzata anatomica

Tessuto Ripstop: tessuto resistente allo strappo e alla lacerazione

Suola X2 outsole: in gomma Vibram per la trazione sui pedali e a piedi

Ergolace : fermeture à laçage ergonomique pour un ajustement anatomique

Tissu Ripstop : tissu résistant à l'abrasion et à la déchirure

Semelle extérieure X2 : en caoutchouc Vibram pour une meilleure adhérence sur les pédales et dans les parties pédestres



Black/Black  
Available also in FLAT VERSION



FLAT VERSION Weight: 303g



ARTICLE	EAN	MODEL	COLOR	SIZE	OUTSOLE	CLOSURE	UPPER	SRP (€)
TEX2ETR1K4610	Various		Teal Blue/Black					129
TEX2ETR1K5886	Various	<b>Terra Ergolace X2</b>	Olive/Caramel	36-48	Nylon Shank, EVA Midsole, Vibram Tread	Laces	Ripstop Fabric	129
TEX2ETR1K1010	Various		Black/Black					129
TEX2ETF1K1010	Various	<b>Terra Ergolace X2 Flat</b>	Black/Black	36-48	EVA Midsole, Vibram Megagrip Tread	Laces	Ripstop Fabric	129



GRAVITA TENSOR è una robusta e leggera scarpa da mountain bike con forma adatta per il gravity di tipo competitivo. Pronta per la gara.

GRAVITA TENSOR est une chaussure de VTT robuste, légère et ajustée Gravity, prête pour la compétition.

## GRAVITA TENSOR

Intended use: DH, ENDURO

Weight: 410g

Suola Clip-in Gravita: mescola Vibram Megagrip e tassellatura sviluppata per l'aderenza con il pedale e il controllo della bici

Tensor: calzata precisa e aderenza sul piede per le prestazioni

Puntale corazzato in TPU stampato ad iniezione: protezione solida del piede durante le guide "sporche"  
Tessuto Ripstop: tessuto resistente allo strappo e alla lacerazione

Semelle Clip-in Gravity : Composition Vibram Megagrip développée pour l'adhérence avec la pédale et le contrôle du vélo

Tensor : ajustement précis et adhérence au pied pour la performance

Bout renforcé en TPU moulé par injection : protection solide du pied lors de randos sur terrain boueux

Tissu Ripstop : tissu résistant à l'abrasion et à la déchirure



Available also in FLAT VERSION



FLAT VERSION Weight: 310g



ARTICLE	EAN	MODEL	COLOR	SIZE	OUTSOLE	CLOSURE	UPPER	SRP (€)
GRX6TTC1C1010	Various	<b>Gravita Tensor</b>	Black/Black	36-48	Nylon Shank, EVA Midsole, Vibram Xs Trek EVO Tread	Laces + Instep Velcro	Ripstop Fabric + TPU Reinforcements	179
GRX6TTF1C1010	Various	<b>Gravita Tensor Flat</b>	Black/Black	36-48	EVA Midsole, Vibram Megagrip Tread	Laces + Instep Velcro	Ripstop Fabric + TPU Reinforcements	179



GRAVITA VERSOR è una versatile e leggera scarpa con lacci da mountain bike ideale per chi usa i pedali flat nei suoi trail di downhill assistiti con la seggiovia.

GRAVITA VERSOR est une chaussure de vélo de montagne à lacets polyvalente et légère. Elle est idéale pour ceux qui utilisent des pédales plates dans les pistes de descente acces et lorsqu'il faut utiliser télésiège pour y accéder.

## GRAVITA VERSOR

Intended use: DH, ENDURO

Weight: 355g

Suola Clip-In Gravita: mescola Vibram Megagrip e tassellatura sviluppata per l'aderenza con il pedale e il controllo della bici

Ergolace: chiusura a lacci ergonomica per una calzata anatomica

Tessuto Ripstop: tessuto resistente allo strappo e alla lacerazione

Semelle Clip-In Gravita : Composition Vibram Megagrip développée pour l'adhérence avec la pédale et le contrôle du vélo

Ergolace : fermeture à laçage ergonomique pour un ajustement anatomique

Tissu Ripstop : tissu résistant à l'abrasion et à la déchirure



Available also in FLAT VERSION



FLAT VERSION Weight: 270g



ARTICLE	EAN	MODEL	COLOR	SIZE	OUTSOLE	CLOSURE	UPPER	SRP (€)
GRX6VTC1K7085	Various	<b>Gravita Versor</b>	Grey/Mud	36-48	Nylon Shank, EVA Midsole, Vibram Xs Trek EVO Tread	Laces	Ripstop Fabric	139
GRX6VTF1K7085	Various	<b>Gravita Versor Flat</b>	Grey/Mud	36-48	EVA Midsole, Vibram Megagrip Tread	Laces	Ripstop Fabric	139



TERRA ERGOLACE GTX è progettata per essere adattabile, passando facilmente da strade gravel a singletrack e viceversa. Il supporto della calzata la rende una scelta ideale per avventure prolungate, dove il comfort è fondamentale giorno dopo giorno.

La TERRA ERGOLACE GTX a été conçue pour s'adapter, passant facilement des routes gravel aux singletrack et vice-versa. Le maintien de la chaussure en fait un choix idéal pour les longues aventures, où le confort jour après jour est essentiel.

## TERRA

### ERGOLACE X2 GTX NEW

Intended use: TRAIL, GRAVEL, BIKEPACKING

Weight: 389g

Membrana Gore-Tex Prism 3L: protezione impermeabile e traspirante a triplo strato  
Pronta per ogni avventura: scelta ideale per lunghe avventure in cui il comfort prolungato, giorno dopo giorno, è fondamentale. Progettata per essere adattabile, passando facilmente da strade gravel a singletrack e viceversa

Ergolace: allacciatura ergonomica per una fit anatomico

Suola X2: Vibram XS Trek Evo per una trazione sia in sella sia a piedi

Membrane Gore-tex prism 3l : protection imperméable respirante à trois couches

Prêt pour toutes les aventures : le choix idéal pour les aventures prolongées où le confort jour après jour est essentiel. Conçue pour être adaptable, elle passe facilement des routes de gravel aux singletrack et vice-versa.

Ergolace : fermeture à lacets ergonomique pour un ajustement anatomique

Semelle extérieure X2 : vibram xs trek evo pour l'adhérence, sur et en dehors du vélo



ARTICLE	EAN	NEW	MODEL	COLOR	SIZE	OUTSOLE	CLOSURE	UPPER	SRP (€)
TEX2EGR1V1410	Various	<b>NEW</b>	<b>Terra Ergolace X2 GTX</b>	Ice Grey/Black	38-48	X2 outsole – nylon shank, EVA midsole and Vibram tread	Ergolace lace-up pattern	Ripstop fabric with GTX membrane	189
TEX2EGR1V1210	Various	<b>NEW</b>	<b>Terra Ergolace X2 GTX</b>	Anthracite/Black	38-49	X2 outsole – nylon shank, EVA midsole and Vibram tread	Ergolace lace-up pattern	Ripstop fabric with GTX membrane	189



TERRA ARTICA X5 GTX è la nostra scarpa da ciclismo invernale off-road. Isolata e dotata di una membrana GORETEX impermeabile e traspirante, è una scarpa versatile, affidabile e adatta a qualsiasi tipo di terreno. Ideale per gravel, mountain bike e avventure off-road.

La TERRA ARTICA X5 GTX est notre chaussure de cyclisme hivernal tout-terrain. À la fois isolante et équipée d'une membrane GORETEX respirante et imperméable, c'est une chaussure polyvalente qui est fiable pour les sorties tout-terrain, le gravel, le VTT et au-delà.

**TERRA**  
**ARTICA X5 GTX**

Intended use: GRAVEL, MTB

Weight: 432g

Artica: scarpa invernale impermeabile, traspirante e isolata

Suola X5 in nylon e gomma: assicura efficienza di pedalata assieme a una trazione in fuoristrada affidabile e sicura

Artica : chaussure d'hiver imperméable, respirante et isolante

Semelle extérieure en nylon et caoutchouc X5 offre une efficacité de pédalage ainsi qu'une traction tout-terrain rassurant et sûre



ARTICLE	EAN	MODEL	COLOR	SIZE	OUTSOLE	CLOSURE	UPPER	SRP (€)
TER5AGR1V1010	Various	<b>Terra Artica X5 GTX</b>	Black/Black	40-48	X5 nylon outsole with rubber treads	1x BOA L6 dial & ankle Velcro strap	High-density PU upper + Ripstop fabric	259
TER5AGR1V3510	Various		Purple/Black					259

# SOCKS

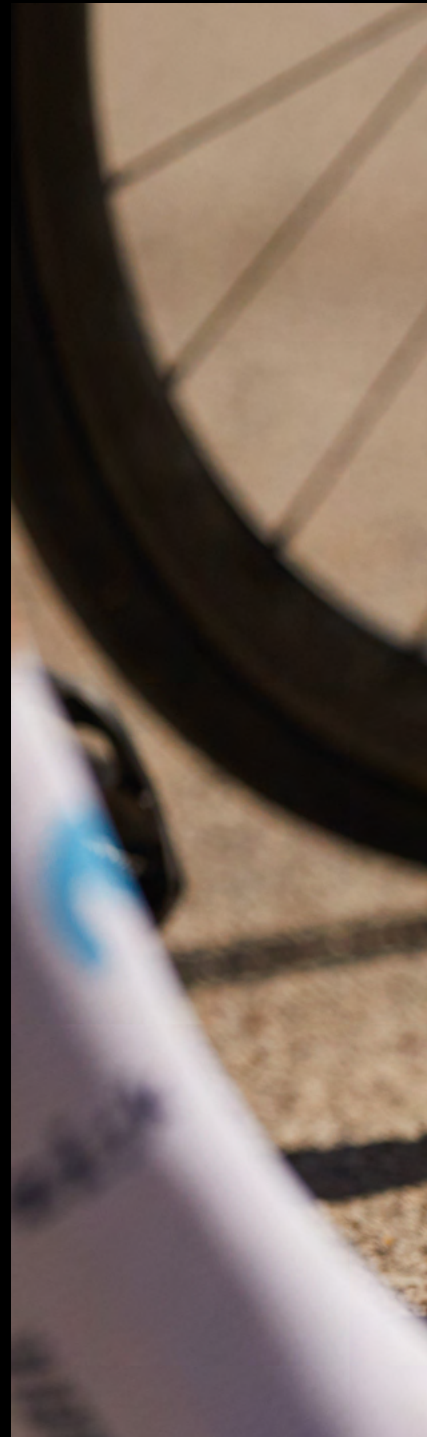





## PERFORMANCE CYCLING SOCKS NEW

Intended use: ROAD

I nostri calzini da ciclismo ad alte prestazioni, realizzati in maglia con filato antibatterico Q-Skin® per un comfort traspirante e che assorbe l'umidità durante ogni ride.

- Filato Q-Skin®: altamente assorbente con proprietà antimicrobiche
- Zone in spugna nell'area delle tacchette: evita punti di pressione
- Costruzione sottile e leggera per migliorare la traspirabilità

Nos chaussettes performantes pour le cyclisme sur route, tricotées à partir du fil Q-Skin® anti-microbien pour un confort respirant et évacuant l'humidité à chaque sortie.

- Q-Skin® : haute capacité d'évacuation de l'humidité et propriétés anti-microbiennes
- Zones en tissu éponge sur les cales : évite les points de pression
- Construction fine et légère pour améliorer la respirabilité



## TEAM EDITION CYCLING SOCKS NEW

Intended use: OFF-ROAD, ROAD RACING

Calzini da ciclismo colorati e con design deciso progettati per mantenere i piedi asciutti e in movimento, dando al team fizik comfort e stile.

- Filato Techno PE: altamente assorbente con proprietà antimicrobiche
- Zone in spugna nell'area delle tacchette e sull'arcata plantare: evita punti di pressione
- Tallone e punta più spessi per migliorare il comfort
- Costruzione a coste sulla gamba

Chaussettes de cyclisme colorées et audacieuses conçues pour garder les pieds au sec et rouler en représentant l'équipe Fizik dans le confort et le style.

- Fil Techno PE : haute capacité d'évacuation de l'humidité et propriétés anti-microbiennes
- Zones en tissu éponge sur les cales et le cou-de-pied : évite les points de pression
- Talon et avant pied plus épais pour améliorer le confort
- Construction en côtes sur la jambe



## OFF-ROAD CYCLING SOCKS NEW

Intended use: OFF-ROAD

Calzini da ciclismo off-road comodi e resistenti, progettati per offrire una migliore traspirabilità e supporto duraturo durante grandi avventure lontano dall'asfalto.

- Filato Techno PE: altamente assorbente con proprietà antimicrobiche
- Zone in spugna nella zona delle tacchette e sull'arcata plantare: evita punti di pressione
- Tallone e punta più spessi per migliorare il comfort
- Costruzione a coste sulla gamba

Chaussettes de cyclisme tout-terrain confortables et résistantes, conçues pour offrir une meilleure respirabilité et un soutien durable lors des grandes aventures hors du bitume.

- Fil Techno PE : haute capacité d'évacuation de l'humidité et propriétés anti-microbiennes
- Zones en tissu éponge sur les cales et le cou-de-pied : évite les points de pression
- Talon et avant pied plus épais pour améliorer le confort
- Construction en côtes sur la jambe



ARTICLE	EAN	NEW	MODEL	COLOR	SIZE	MATERIAL	SRP (€)
FZKSOCKSRO1000	Various	<b>NEW</b>	<b>Performance Cycling Socks</b>	Black	S (35-39) M (40-43) L (44-47)	QSkin yarn	18,90
FZKSOCKSRO2000	Various	<b>NEW</b>		White			18,90
FZKSOCKSTE382000	Various	<b>NEW</b>	<b>Team Edition Cycling Socks</b>	Lilac-White	S (35-39) M (40-43) L (44-47)	Techno PE yarn	18,90
FZKSOCKSOF7010	Various	<b>NEW</b>	<b>Off-Road Cycling Socks</b>	Grey-Black	S (35-39) M (40-43) L (44-47)	Techno PE yarn	18,90

## SHOES ACCESSORIES &amp; PARTS

ARTICLE	EAN	MODEL	COLOR	SIZE	DESCRIPTION	SRP (€)
<b>COVER</b>						
FZTCW1000	-	<b>Windproof Toe Cover</b>	Black	XS (36-40) M (41-44) XL (45-48)	PU Cloth Main Fabric, Microfiber Toe Cap & Puller, Bottom PU Reinforced	25
FZSCWP109400	-	<b>Waterproof Winter Overshoe</b>	Black/ Reflective	S (36-39) M (40-43) L (44-46) XL (47-48)	WP and Windproof Upper, Rubberized Bottom for Better Grip, Reflective logo and Piping	59
<b>KIT BOA SHOES</b>						
120026410	8058364168937	<b>LI2 Dial C KIT left and right</b>	Black	-	1 boa left + 1 boa right compatible with Vento Omnia	37,50
120025720	8058364161334	<b>LI2 Dial B KIT left and right</b>	White	-	1 boa left + 1 boa right compatible with Stabilita Carbon	37,50
120026210	8058364161327	<b>LI2 Dial B KIT left and right</b>	Black	-	1 boa left + 1 boa right compatible with new Vento Infinito Carbon, Vento Infinito Knit Carbon and Stabilita Carbon, Vento Ferox Carbon, Tempo Decos Carbon	37,50
120025620	8058364161310	<b>LI2 Dial A KIT left and right</b>	White	-	1 boa left + 1 boa right compatible with Tempo Decos Carbon	37,50
120026010	8058364161341	<b>IP1 KIT left and right</b>	Black	-	1 boa left + 1 boa right compatible with all fi'zi:k R1M-BC, INFINITO R1, ARIA R3, OVERCURVE R4, OVERCURVE R5, TRIATHLON TRANSIRO R1 and R3 shoes, M3B (model from ss 2017 to 2018), M4B (model 2018), INFINITO X1 and VENTO OVERCURVE X3	25
120025920	8058364161358	<b>IP1 KIT left and right</b>	White/ Transparent	-	1 boa left + 1 boa right compatible with all fi'zi:k R1M-BC, INFINITO R1, ARIA R3, OVERCURVE R4, OVERCURVE R5, TRIATHLON TRANSIRO R1 and R3 shoes, M3B (model from ss 2017 to 2018), M4B (model 2018), INFINITO X1 and VENTO OVERCURVE X3	25
120026110	8058364161365	<b>L6 KIT dial D left and right</b>	Black	-	1 boa left + 1 boa right compatible with all fi'zi:k M4B (model 2017), TERRA X5 (model 2018) and M6B (model from 2017 to current), TERRA CLIMA X2, TERRA ARTICA X2, Terra Artica GTX and Tempo Artica GTX	19
120025510	8058364161303	<b>LI2 Dial A KIT left and right</b>	Black	-	1 boa left + 1 boa right compatible with Vento Ferox Carbon and Tempo Decos Carbon	37,50
120026310	8058364161389	<b>L6 dial K KIT left and right / W CS1</b>	Black	-	1 boa left + 1 boa right compatible with all Terra Atlas shoes	19
120025820	8058364161372	<b>L6 KIT dial D left and right</b>	White	-	1 boa left + 1 boa right compatible with Tempo Artica GTX	19
<b>TOE STUDS KIT</b>						
KTOESTUD1010	8058364147420	<b>Toe Studs Kit</b>	Black	-	Toe Studs Kit - Vento Ferox Carbon & Terra Atlas (pair)	7,99
KTOESTUD5B5B	8058364149127		Mint	-	Toe Studs Kit - Vento Ferox Carbon (pair)	7,99
KTOESTUD9090	8058364149134		Yellow Fluo	-	Toe Studs Kit - Vento Ferox Carbon (pair)	7,99
<b>SHOES SPARE PARTS</b>						
FZHSPR1C1000	-	<b>Heel Skid Plate</b>		S-L	Heel Skid Plate (pair) R1B shoes	15
FZHSPR3C1000	-		Black	S-M-L	Heel Skid Plate (pair) R3B shoes	13
KHPVER21C1000	-			S-L	Heel Skid Plate Vento R2	15

# BARTAPES





# TOUCH



## TACKY

**2mm / 2.7mm / 3mm**

Finitura che consegna una superficie aderente e antiscivolo per un grip superiore in ogni condizione.

Finition qui présente une surface confortable et antidérapante pour une adhérence supérieure dans toutes les conditions.



## CLASSIC

**2mm / 3mm**

Una texture durevole e traforata come la pelle, con un look tradizionale e una superficie liscia che agevola le transizioni tra le diverse posizioni di guida.

Une texture durable similaire à du cuir perforé, avec une esthétique traditionnelle et une superficie lisse qui permet de glisser facilement par rapport à différentes positions de conduite.



## SOFT

**3mm**

Una superficie dal look opaco e con finitura setosa, che assorbe l'umidità.

Une surface soyeuse, absorbant l'humidité, avec un aspect mat.

# CONSTRUCTION

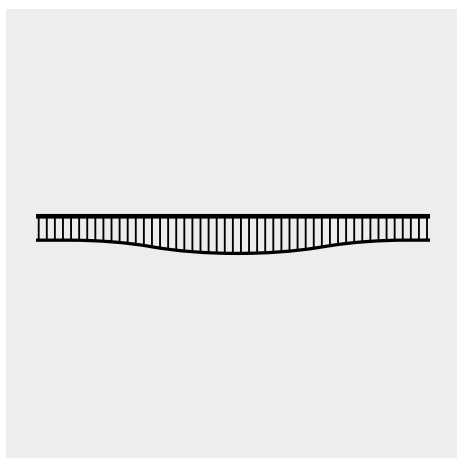

## MICROTEX

**2mm**

La più sottile delle opzioni per una presa precisa e per il controllo.

La plus précise des options pour une adhérence et un contrôle précis.

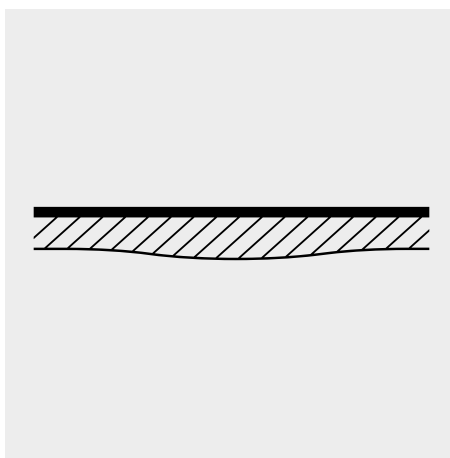

## SOLOCUSH

**2.7mm**

La nostra costruzione più filante e ammortizzata, una piattaforma monostrato su cui fare affidamento durante le uscite più lunghe senza scendere a compromessi con il peso.

Notre fabrication la plus profilée et la plus rembourrée, une plate-forme monocouche sur laquelle vous pouvez compter sur vos plus longues sorties, sans jamais compromettre le poids.

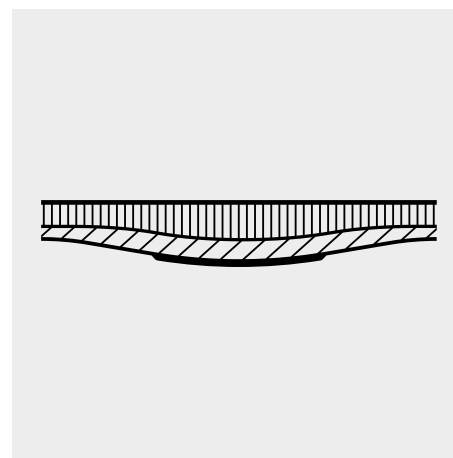

## BONDCUSH

**3mm**

Una schiuma polimerica stratificata di media imbottitura che assorbe i microcolpi trasmessi dall'asfalto. Assieme allo strato esterno in Microtex, questo mix di materiali è la nostra opzione più valida per avere comfort, versatilità e durata.

Un rembourrage de mousse polymère stratifié qui absorbe les micro-coups transmis par l'asphalte. Avec la couche extérieure en Microtex, ce mélange de matériaux est notre meilleure option pour le confort, la polyvalence et la durabilité.

VENTO  
**MICROTEX  
 TACKY**

Intended use: ROAD RACING

Microtex è la più sottile delle opzioni per la maneggevolezza e il controllo. La finitura Tacky produce una superficie aderente e antiscivolo con una struttura in rilievo per una presa superiore in ogni condizione.

Le Microtex est l'option la plus fine pour une manipulation et un contrôle sans faille. La finition collante offre une surface antidérapante avec une texture en relief pour une adhérence optimale dans toutes les conditions.



ARTICLE	EAN	MODEL	COLOR	CONSTRUCTION	TOUCH	THICKNESS	SRP (€)
BT09000A00042	8021890466457	<b>Vento Microtex Tacky</b>	Black	Microtex	Tacky	2mm	40,90
BT09000A00044	8021890466464		White				40,90
BT09000A00012	8021890466440		Red				40,90
BT09000A00047	8021890466488		Orange Fluo				40,90
BT09000A00050	8021890466495		Pink Fluo				40,90
BT09000A00046	8021890466471		Yellow Fluo				40,90
BT09000A00051	8021890466501		Lilla Fluo				40,90
BT09000A00009	8021890466433		Celeste				40,90
BT15000A20042	8021890482693		Black/Celeste				43,90
BT15000A40042	8021890482716		Black/White				43,90
BT15000A50042	8021890482723		Black/Red				43,90
BT15000A60042	8021890482730		Black/Grey				43,90

VENTO

**SOLOCUSH  
TACKY**

Intended use: ROAD RACING

Solocush è la nostra costruzione più filante e morbida, con la sua generosa struttura monostrato su cui fare affidamento durante le uscite più lunghe ma senza mai scendere a compromessi con il peso. La finitura Tacky produce una superficie aderente e antiscivolo con una struttura in rilievo per una presa superiore in ogni condizione.

Solocush est notre fabrication la plus fine et la plus souple, avec sa généreuse structure monocouche sur laquelle vous pouvez compter sur vos sorties plus longues sans jamais compromettre le poids. La finition Tacky offre une surface confortable et anti-dérapante avec une surélevée pour une adhérence supérieure en toutes conditions.



ARTICLE	EAN	MODEL	COLOR	CONSTRUCTION	TOUCH	THICKNESS	SRP (€)
BT11000A00042	8021890466686		Black				43,90
BT11000A00044	8021890466693		White				43,90
BT11000A00055	8021890467034		Blue				43,90
BT11000A00025	8021890466679		Green				43,90
BT11000A00012	8021890466655		Red				43,90
BT11000A00011	8021890466648		Pink				43,90
BT11000A00014	8021890466662		Yellow				43,90
BT11000A00047	8021890466716	<b>Vento Solocush Tacky</b>	Orange Fluo	Solocush	Tacky	2,7mm	43,90
BT11000A00050	8021890466723		Pink Fluo				43,90
BT11000A00046	8021890466709		Yellow Fluo				43,90
BT11000A00051	8021890466730		Lilla Fluo				43,90
BT11000A00009	8021890466631		Celeste				43,90
BT11000A00057	8021890498885		Light Grey				43,90
BT11000A00058	8021890498892		Dark Grey				43,90
BT11000A00059	8021890498908		Mint Green				43,90



TEMPO

## MICROTEX CLASSIC

Intended use: ROAD

Microtex è la più sottile delle opzioni per la maneggevolezza e il controllo. Classic Touch è una resistente texture traforata simile alla pelle, con un'estetica tradizionale e una superficie liscia che si maneggia facilmente nelle varie posizioni di guida.

Microtex est la plus fine des solutions pour la prise et le contrôle. Classic Touch est une texture perforée d'une résistance semblable au cuir, avec une esthétique traditionnelle et une surface lisse qui permet de changer aisément la position des mains.



TEMPO

## MICROTEX BONDCUSH CLASSIC

Intended use: ROAD

Bondcush è una schiuma polimerica stratificata di media densità, che favorisce l'assorbimento dei colpi trasmessi dalla strada. Unità assieme allo strato esterno in Microtex questo mix di materiali diventa la nostra migliore opzione per avere quel comfort, quella versatilità e quella durezza perfette per avventurarsi su qualsiasi tipo di strada. Classic Touch è una resistente texture traforata simile alla pelle, con un'estetica tradizionale e una superficie liscia che si maneggia facilmente nelle varie posizioni di guida.

Bondcush est une mousse polymère stratifiée de densité moyenne, qui favorise l'absorption des coups transmis par la route. Associé à une couche externe en Microtex, ce mélange de matériaux devient notre meilleure solution procurant le confort, la polyvalence et la durabilité idéals pour pédaler sur tout type de route. Classic Touch est une texture perforée d'une résistance semblable au cuir, avec une esthétique traditionnelle et une surface lisse qui permet de changer aisément la position des mains.



ARTICLE	EAN	MODEL	COLOR	CONSTRUCTION	TOUCH	THICKNESS	SRP (€)
BT10000A00032	8021890466600	Tempo Microtex Classic	Black	Microtex	Classic	2mm	23,90
BT10000A00010	8021890466549		White				23,90
BT10000A00055	8021890467027		Blue				23,90
BT10000A00025	8021890466594		Green				23,90
BT10000A00012	8021890466563		Red				23,90
BT10000A00011	8021890466556		Pink				23,90
BT10000A00014	8021890466570		Yellow				23,90
BT10000A00045	8021890466617		Orange				23,90
BT10000A00018	8021890466587		Honey				23,90
BT10000A00006	8021890466525		Silver				23,90
BT10000A00009	8021890466532		Celeste				23,90
BT13000A00032	8021890466891		Tempo Microtex Bondcush Classic				Black
BT13000A00010	8021890466839	White		30,90			
BT13000A00018	8021890466877	Honey		30,90			

## TEMPO

**MICROTEX BONDCUSH  
SOFT**

Intended use: ROAD

Bondcush è una schiuma polimerica stratificata di media densità, che favorisce l'assorbimento dei colpi trasmessi dalla strada. Unita assieme allo strato esterno in Microtex questo mix di materiali diventa la nostra migliore opzione per avere quel comfort, quella versatilità e quella durezza perfette per avventurarsi su qualsiasi tipo di strada. Soft Touch è una superficie dall'aspetto opaco, con fattezze setose che assorbono l'umidità.

Bondcush est une mousse polymère stratifiée de densité moyenne, qui favorise l'absorption des coups transmis par la route. Associé la couche externe en Microtex, ce mélange de matériaux devient notre meilleure solution procurant le confort, la polyvalence et la durabilité idéal pour pédaler tout type de route. La finition Soft touch procure un toucher doux et une surface d'aspect mat et soyeuse absorbant l'humidité.



## TEMPO

**MICROTEX BONDCUSH  
TACKY - Les Classiques**

Intended use: ROAD

Bondcush è una schiuma polimerica stratificata di media densità, che favorisce l'assorbimento dei colpi trasmessi dalla strada. Unita assieme allo strato esterno in Microtex questo mix di materiali diventa la nostra migliore opzione per avere quel comfort, quella versatilità e quella durezza perfette per avventurarsi su qualsiasi tipo di strada. La finitura Tacky produce una superficie aderente e antiscivolo con una struttura in rilievo per una presa superiore in ogni condizione.

Bondcush est une mousse polymère stratifiée de densité moyenne, qui favorise l'absorption des coups transmis par la route. Associé la couche externe en Microtex, ce mélange de matériaux devient notre meilleure solution procurant le confort, la polyvalence et la durabilité idéal pour pédaler tout type de route. La finition Tacky offre une surface confortable et anti-dérapante avec une structure surélevée pour une grip parfait en toute circonstance.

**Le Classiques**  
Limited Edition



ARTICLE	EAN	MODEL	COLOR	CONSTRUCTION	TOUCH	THICKNESS	SRP (€)
BT14000A00002	8021890466914	<b>Tempo Microtex Bondcush Soft</b>	Black	Microtex Bondcush	Soft	3mm	30,90
BT14000A00012	8021890466969	<b>Tempo Microtex Bondcush Soft</b>	Red	Microtex Bondcush	Soft	3mm	30,90
BT16000A00042	8021890497543	<b>Tempo Microtex Bondcush Tacky</b>	Le Classiques	Microtex Bondcush	Tacky	3mm	43,90

TERRA

## MICROTEX BOND CUSH TACKY

Intended use: GRAVEL

Bondcush è una schiuma polimerica stratificata di media densità, che favorisce l'assorbimento dei colpi trasmessi dalla strada. Unita assieme allo strato esterno in Microtex questo mix di materiali diventa la nostra migliore opzione per avere quel comfort, quella versatilità e quella durezza perfette per avventurarsi su qualsiasi tipo di strada. Il supporto inferiore in gel ha una doppia funzione: rimpiazza il tradizionale nastro adesivo per una rimozione e una pulizia più facili in caso di sostituzione e assorbe i colpi della strada senza dare la sensazione di essere troppo gommoso. La finitura Tacky favorisce una presa sicura e antiscivolo garantendo un grip superiore in tutte le condizioni.

Bondcush est une mousse polymère stratifiée de densité moyenne, qui favorise l'absorption des coups transmis par la route. Associé la couche externe en Microtex, ce mélange de matériaux devient notre meilleure solution procurant le confort, la polyvalence et la durabilité idéal pour pédaler tout type de route. Un support en gel collant remplit deux fonction: il remplace le ruban adhésif pour un démontage facile du ruban pour un remplacement et amortit vibrations sans toutefois être trop mou. La finition Tacky offre une surface anti-dérapante pour un grip parfait en toute circonstance.



ARTICLE	EAN	MODEL	COLOR	CONSTRUCTION	TOUCH	THICKNESS	SRP (€)
BT12000A00002	8021890466747	<b>Terra Microtex Bondcush Tacky</b>	Black	Microtex Bondcush	Tacky	3mm	43,90
BT12000A00016	8021890466761		White				43,90
BT12000A00012	8021890466754		Red				43,90
BT12000A00052	8021890466778		Dark Blue				43,90
BT12000A00053	8021890466785		Green/Blue				43,90
BT12000A00054	8021890466792		Brown				43,90
BT12000A00057	8021890498915		Light Grey				43,90

VENTO

**MICROTEX TACKY 2mm  
BOX 10 KITS (20 ROLLS)**

**1 kit contiene:**

- 2 rotoli di nastro Vento Microtex Tacky 2mm nero
- 2 strisce di nastro extra
- 2 tappi manubrio
- 2 nastri di finitura

**1 kit contient :**

- 2 rouleaux de ruban adhésif noir Vento Microtex Tacky 2mm
- 2 bandes de ruban adhésif supplémentaires
- 2 bouchons de cintre
- 2 rubans de finition



10 x

TEMPO

**BONDCUSH SOFT 3mm  
BOX 10 KITS (20 ROLLS)**

**1 kit contiene:**

- 2 rotoli di nastro Tempo Bondcush 3mm Soft nero
- 2 strisce di nastro extra
- 2 tappi manubrio
- 2 nastri di finitura

**1 kit contient :**

- 2 rouleaux de ruban adhésif noir souple Tempo Bondcush 3mm
- 2 bandes de ruban adhésif supplémentaires
- 2 bouchons de cintre
- 2 rubans de finition



10 x

**BAR GEL KIT**

- 2 strisce di gel curve tagliate su misura
- 2 strisce di gel rettilinee tagliate su misura
- 2 strisce di chiusura superiori

- 2 pièces de gel cintrées ajustables à la dimension souhaitée
- 2 pièces de gel droites ajustables à la dimension souhaitée
- 2 bandes adhésives pour les extrémités



ARTICLE	EAN	MODEL	COLOR	CONSTRUCTION	TOUCH	THICKNESS	SRP (€)
FZKTAPE000000	8021890579638	<b>Vento Microtex Tacky 10 Kits (20 rolls)</b>	Black	Microtex	Tacky	2mm	-
FZKTAPE020000	8021890579652	<b>Tempo Bondcush Soft 10 Kits (20 rolls)</b>	Black	Microtex Bondcush	Soft	3mm	-
BG02000A10003	8021890580634	<b>Bar Gel Kit</b>	4 Pieces of Gel (2 curved + 2 straight) + 2 wrap strips				20



crankbrothers







## PEDALS

### UNA RIVOLUZIONE IN TERMINI DI PERFORMANCE ED AFFIDABILITÀ

NUOVI MODELLI, TECNOLOGIE AVANZATE E COMPONENTI D'ALTA GAMMA SI COMBINANO NELLA NOSTRA LINEA DI PEDALI, LA PIÙ INNOVATIVA DI SEMPRE.

**UNE RÉVOLUTION EN TERMES DE PERFORMANCE ET FIABILITÉ**  
DE NOUVEAUX MODÈLES, DES TECHNOLOGIES INNOVANTES ET DES  
COMPOSANTS HAUT DE GAMME CARACTÉRISENT NOTRE LIGNE DE PÉDALES,  
LE TOUT DANS UN NIVEAU DE FINITION JAMAIS ATTEINT.



## COMPONENTI DI QUALITÀ SUPERIORE COMPOSANTS DE QUALITÉ PREMIUM

### CUSCINETTI ENDURO® | ROULEMENT ENDURO®

#### SISTEMA DI CUSCINETTI ESTERNI PREMIUM

- Progettati in modo specifico per pedali (bassa velocità, alto valore di coppia)
- Materiali, lubrificante e guarnizioni di qualità premium
- Maggior resistenza alla corrosione
- Tolleranze maggiori per un fit più preciso

(\*) In tutti i nuovi pedali prodotti verrà installato al posto dell'Enduro Bearing l'Enduro Max cartridge bearing, ancora più affidabile.



#### ROULEMENT EXTERNE PREMIUM

- Conçu spécifiquement pour les pédales (basse vitesse, couple élevé)
- Matériaux, roulements et graisse de qualité supérieure
- Résistance à la corrosion
- Tolérances supérieures pour un ajustement précis

(\*) Pour toute la nouvelle production de pédales, le roulement à cartouche Enduro Max, encore plus fiable, sera monté à la place du roulement Enduro.

### CUSCINETTI IGUS LL-GLIDE | ROULEMENT IGUS LL-GLIDE

#### SISTEMA DI CUSCINETTI INTERNO PREMIUM

- Sviluppato in esclusiva per Crankbrothers
- Una performance otto volte superiore dai test in laboratorio di igus
- Una performance fino a 74 volte migliore dai test condotti da Crankbrothers
- Ottime prestazioni anche in condizioni avverse



#### ROULEMENT INTERNE PREMIUM

- Développés en exclusivité pour Crankbrothers
- Une performance 8 fois supérieure selon les tests de laboratoire aigus
- Une performance 74 fois supérieure selon nos derniers tests en interne.
- Effectué dans les conditions les plus extrêmes

### SISTEMA A DOPPIA GUARNIZIONE | DOUBLE SYSTÈME D'ÉTANCHÉITÉ

#### GUARNIZIONE INTERNA DOUBLE-LIP E GUARNIZIONE ESTERNA

- Impedisce l'entrata di sporco e acqua all'interno del pedale
- Test di laboratorio e su strada condotti in condizioni estreme
- Previene dalla corrosione dei pedali e ne aumenta la durata nel tempo

#### JOINT INTERNE DOUBLE-LIP ET JOINT EXTÉRIEUR

- Empêche l'eau et la boue de pénétrer à l'intérieur de la pédale
- Testé en laboratoire et sur le terrain dans les pires conditions
- Protège de la corrosion et prolonge la vie de la pédale



guarnizione interna double-lip  
joint interne double-lip

guarnizione esterna  
joint extérieur







# CLIP-IN PEDALS MALLET DH



MALLET DH 11



MALLET DH RACE

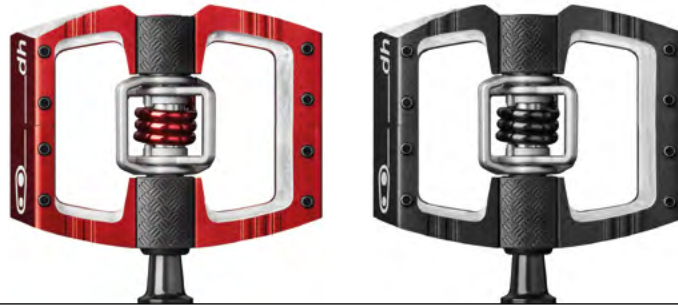

ARTICLE	UPC	MODEL	BODY COLOR	SPRING COLOR	WEIGHT*	WING MATERIAL	Q-FACTOR	PRICE (€)
16096	641300160966	<b>mallet dh 11</b>	black	gold	445g	titanium	57mm	350
16094	641300160942	<b>mallet dh race</b>	black	black	479g	cast steel	57mm	180
16095	641300160959		red	red				180

(\*) Tutti i pesi sono intesi per coppia di pedali | Tous les poids indiqués sont par paire de pédales

CLIP-IN PEDALS  
MALLET E

11 MALLET E 11



MALLET E



MALLET E LS  
(LONG SPINDLE)



SPLATTER EDITION

ARTICLE	UPC	MODEL	BODY COLOR	SPRING COLOR	WEIGHT*	WING MATERIAL	Q-FACTOR	PRICE (€)
16093	641300160935	<b>mallet e 11</b>	black	gold	385g	titanium	52mm	350
15990	641300159908	<b>mallet e</b>	black	black	419g	cast steel	52mm	180
15991	641300159915		electric blue	blue				
16080	641300160805	<b>mallet e ls</b>	blue**	black	424g	cast steel	57mm	180
16247	641300162472		silver**	black				
16708	641300167088	<b>mallet e ls</b>	lime green/black**	black	424g	cast steel	57mm	180
16710	641300167101	<b>splatter edition</b>	blue/black**	black				

(\*) Tutti i pesi sono intesi per coppia di pedali | Tous les poids indiqués sont par paire de pédales

(\*\*) Fino ad esaurimento scorte | Jusqu'à épuisement des stocks



## CLIP-IN PEDALS MALLET TRAIL

MALLET TRAIL

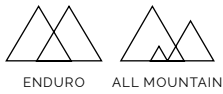

## CLIP-IN PEDALS MALLET 3-2

3 MALLET 3



2 MALLET 2



ARTICLE	UPC	MODEL	BODY COLOR	SPRING COLOR	WEIGHT*	WING MATERIAL	Q-FACTOR	PRICE (€)
16759	641300167590	<b>mallet trail</b>	black	black				180
16760	641300167606		champagne	black	344g	cast steel	57mm	180
16761	641300167613		purple	black				180
15988	641300159885	<b>mallet 3</b>	raw/black	blue	499g	cast steel	52mm	150
15989	641300159892		raw/red**	red				
15987	641300159878	<b>mallet 2</b>	raw/green**	black	508g	stamped steel	52mm	100
15986	641300159861		raw/silver	black				

(\*) Tutti i pesi sono intesi per coppia di pedali | Tous les poids indiqués sont par paire de pédales

(\*\*) Fino ad esaurimento scorte | Jusqu'à épuisement des stocks

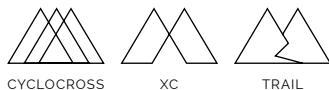

CYCLOCROSS

XC

TRAIL

CLIP-IN PEDALS

CANDY

11

CANDY 11



7

CANDY 7



3

CANDY 3



ARTICLE	UPC	MODEL	BODY COLOR	SPRING COLOR	WEIGHT*	WING MATERIAL	TRACTION PADS	PRICE (€)
15984	641300159847	<b>candy 11</b>	gold	gold	249g	titanium	integrated	500
16178	641300161789		black/electric blue	black				180
15981	641300159816	<b>candy 7</b>	black	black	320g	cast steel	integrated	180
15982	641300159823		red	red				180
16175	641300161758		black	black				150
16177	641300161772	<b>candy 3</b>	dark red**	red	340g	cast steel	included	150
16176	641300161765		slate blue	blue				150

(\*) Tutti i pesi sono intesi per coppia di pedali | Tous les poids indiqués sont par paire de pédales

(\*\*) Fino ad esaurimento scorte | Jusqu'à épuisement des stocks

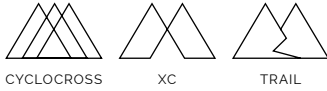

# CLIP-IN PEDALS CANDY

2 CANDY 2



1 CANDY 1

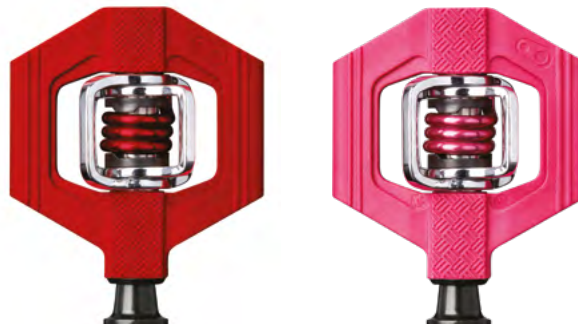

ARTICLE	UPC	MODEL	BODY COLOR	SPRING COLOR	WEIGHT*	WING MATERIAL	TRACTION PADS	PRICE (€)
16173	641300161734	<b>candy 2</b>	dark grey	black	355g	stamped steel	optional	100
16634	641300166340		red	black				100
16169	641300161697	<b>candy 1</b>	black	black	294g	stamped steel	not compatible	60
16171	641300161710		light blue	blue				60
16170	641300161703		red	red				60
16172	641300161727		pink	pink				60

(\*) Tutti i pesi sono intesi per coppia di pedali | Tous les poids indiqués sont par paire de pédales



CYCLOCROSS

XC

TRAIL

## CLIP-IN PEDALS EGGBEATER

11 EGGBEATER 11



3 EGGBEATER 3

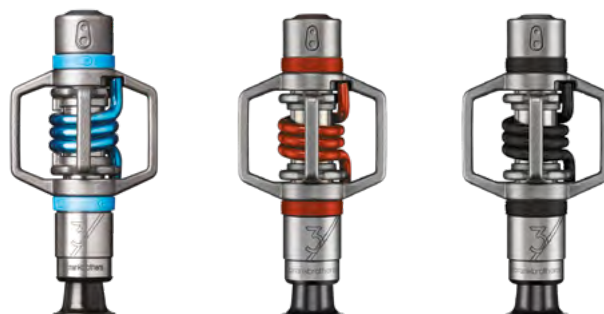

2 EGGBEATER 2



1 EGGBEATER 1

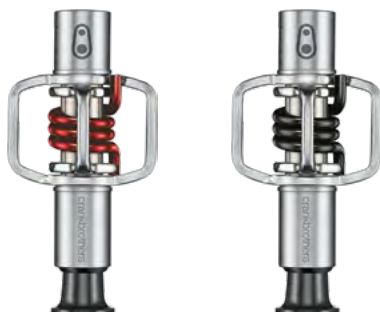

ARTICLE	UPC	MODEL	BODY COLOR	SPRING COLOR	WEIGHT*	WING MATERIAL	TRACTION PADS	PRICE (€)
11495	641300114952	<b>eggbeater 11</b>	gold	gold	179g	titanium	1mm included	500
16098	641300160980	<b>eggbeater 3</b>	light blue	electric blue	280g	cast steel	1mm included	150
15319	641300153197		red	red				150
15859	641300158598		black	black				150
15317	641300153173	<b>eggbeater 2</b>	black	black	285g	stamped steel	optional	100
15985	641300159854		black	green				100
14792	641300147929	<b>eggbeater 1</b>	silver	red	290g	stamped steel	not compatible	60
14791	641300147912		silver	black				60

(\*) Tutti i pesi sono intesi per coppia di pedali | Tous les poids indiqués sont par paire de pédales



# HYBRID PEDALS DOUBLE SHOT

3

DOUBLE SHOT 3

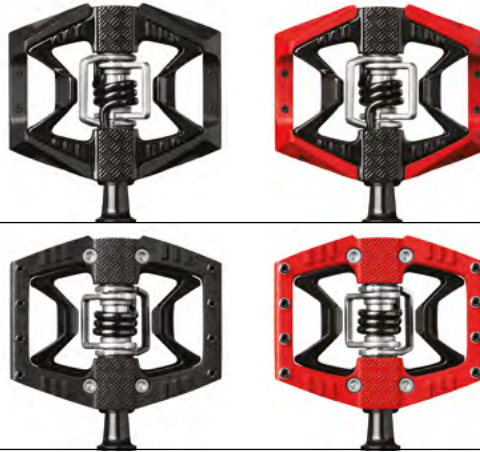

CLIP-IN SIDE

FLAT SIDE

2

DOUBLE SHOT 2



CLIP-IN SIDE

FLAT SIDE

1

DOUBLE SHOT 1

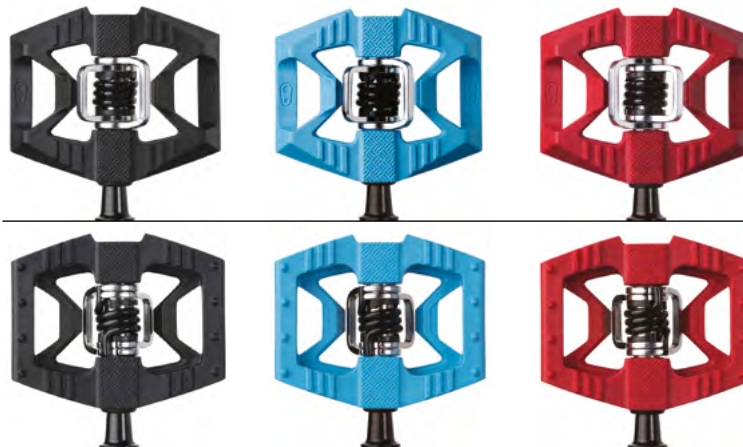

CLIP-IN SIDE

FLAT SIDE

ARTICLE	UPC	MODEL	BODY COLOR	SPRING COLOR	WEIGHT*	BODY MATERIAL	PINS	Q-FACTOR	PRICE (€)
16111	641300161116	<b>double shot 3</b>	black	black	403g	aluminum	8 adjustable	57mm	150
16110	641300161109		red/black	black					150
16006	641300160065	<b>double shot 2</b>	black/silver	blue	395g	aluminum	8 molded	57mm	100
16007	641300160072		orange/black	orange					100
16077	641300160775		blue/black	black					100
16179	641300161796	<b>double shot 1</b>	black	black	331g	composite	8 molded	57mm	60
16181	641300161819		blue	black					60
16180	641300161802		red	black					60

(\*) Tutti i pesi sono intesi per coppia di pedali | Tous les poids indiqués sont par paire de pédales





## FLAT PEDALS

### FIND YOUR PERFECT SIZE

ABBIAMO ANALIZZATO I PROFILI DELLE SUOLE DELLE MIGLIORI MARCHE DI CALZATURE DA MOUNTAIN BIKE E ABBIAMO INDIVIDUATO DUE SUPERFICI DISTINTE PER OTTIMIZZARE L'INTERFACCIA SCARPA/PEDALE PER L'INTERA GAMMA DI MISURE DELLE CALZATURE.

NOUS AVONS PROCÉDÉ À UNE ÉTUDE DES PROFILS DES SEMELLES DES MEILLEURES MARQUES DE CHAUSSURES DE VTT ET À LA SUITE DE ÇA, MIS AU POINT DEUX SURFACES DISTINCTES POUR OPTIMISER L'INTERFACE CHAUSSURE/PÉDALE POUR TOUTE LA GAMME DE TAILLES DE CHAUSSURES.

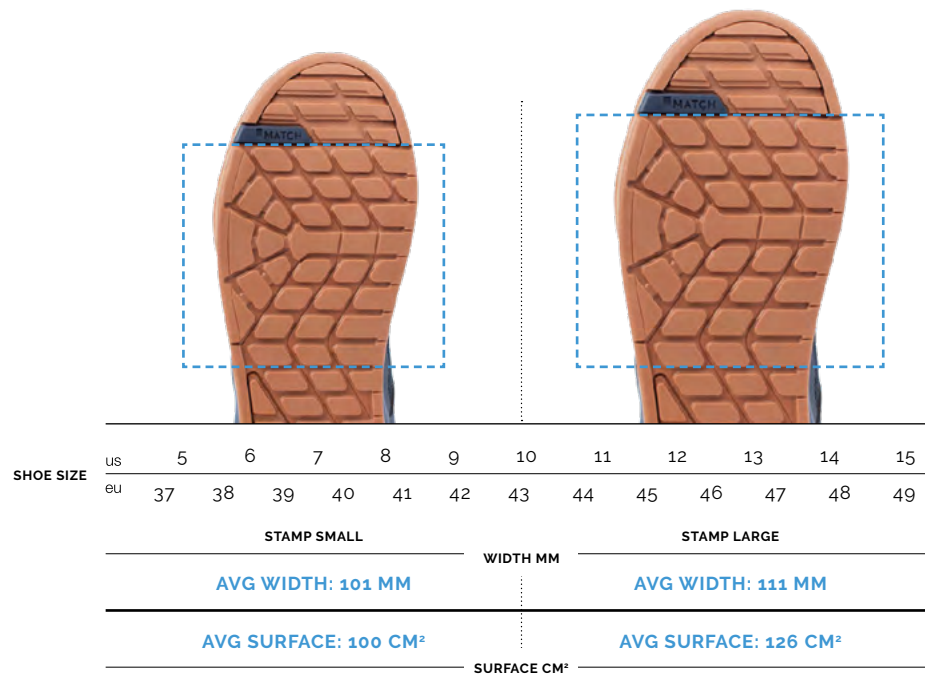

### SUPERFICIE OTTIMALE | SURFACE OPTIMALE

- Basato sull'analisi delle misure delle scarpe e della superficie delle soles
- Due misure, ciascuna con una superficie ottimizzata in base alla taglia
- Aumento del grip, del supporto e del contatto con il pedale
- Riduce il peso e l'area d'impatto con le rocce
- Basée sur l'analyse des dimensions des chaussures et la surface des semelles
- Deux différentes tailles avec des surfaces optimales pour les diverses gammes de tailles de chaussures
- Optimise l'adhérence, le support et l'interface avec le pédale
- Réduit considérablement le poids et prévient des chocs avec le terrain

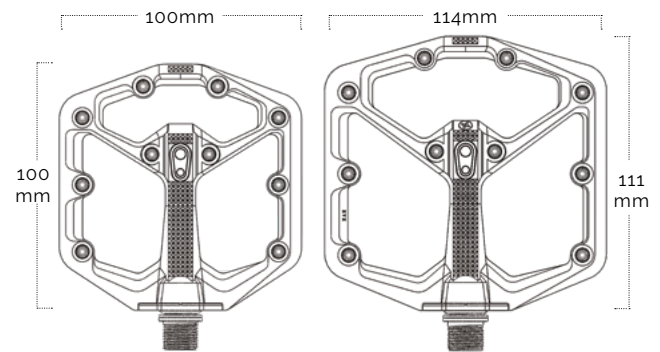

### PROFILO MINIMAL/CONCAVITÀ MASSIMA | PROFIL MINIMAL/CONCAVITE MAXIMALE

- Profilo minimal, 11-13 mm
- Un profilo più fino rispetto alla concorrenza
- Riduce il peso e l'impatto con le rocce
- La piattaforma concava garantisce una presa più salda del piede sul pedale
- Una piattaforma più concava rispetto alla concorrenza
- Profil minimal, 11-13 mm
- Profil plus mince que les produits de la concurrence
- Réduit le poids et les chocs avec le terrain
- Plate forme concave, positionnement du pied plus sûr
- Concavité supérieure aux produits de la concurrence

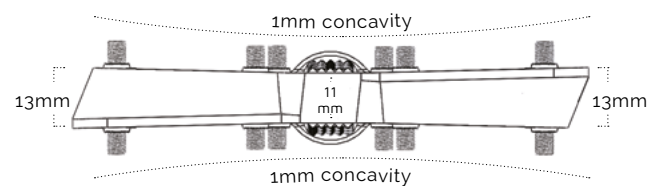



FLAT PEDALS

STAMP



11 STAMP 11



7 STAMP 7

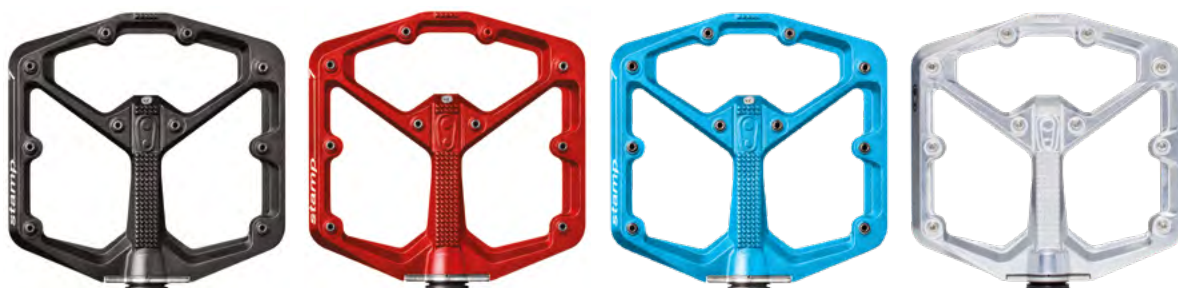

7 STAMP 7  
SPLATTER EDITION



ARTICLE	UPC	MODEL	SIZE	BODY COLOR	WEIGHT*	BODY MATERIAL	THICKNESS	PRICE (€)
16165	641300161659	<b>stamp 11 (large)</b>	large	black/gold	325g	aluminum	11/13 mm	300
16166	641300161666	<b>stamp 11 (small)</b>	small	black/gold	299g	aluminum	11/13 mm	300
16002	641300160027	<b>stamp 7 (large)</b>	large	black	375g	aluminum	11/13 mm	180
16003	641300160034		large	red				180
16635	641300166357		large	electric blue				180
16746	641300167460		large	high polish silver				190
16004	641300160041	<b>stamp 7 (small)</b>	small	black	345g	aluminum	11/13 mm	180
16005	641300160058		small	red				180
16636	641300166364		small	electric blue				180
16747	641300167477		small	high polish silver				190
16702	641300167026	<b>stamp 7 (large) splatter edition</b>	large	lime green**	375g	aluminum	11/13 mm	180
16703	641300167033	<b>stamp 7 (small) splatter edition</b>	small	lime green**	345g	aluminum	11/13 mm	180
16705	641300167057		small	red**				180
16707	641300167071		small	blue**				180

(\*) Tutti i pesi sono intesi per coppia di pedali | Tous les poids indiqués sont par paire de pédales

(\*\*) Fino ad esaurimento scorte | Jusqu'à épuisement des stocks



# FLAT PEDALS STAMP



3 STAMP 3



2 STAMP 2



1 STAMP 1



ARTICLE	UPC	MODEL	SIZE	BODY COLOR	WEIGHT*	BODY MATERIAL	THICKNESS	PRICE (€)
16366	641300163660	<b>stamp 3 (large)</b>	large	black magnesium	386g	magnesium	13.5/16.5 mm	140
16367	641300163677		large	grey magnesium				
16368	641300163684	<b>stamp 3 (small)</b>	small	black magnesium	351g	magnesium	13.5/16.5 mm	140
16369	641300163691		small	grey magnesium				
16362	641300163622	<b>stamp 2 (large)</b>	large	raw silver	494g	die cast aluminum	13.5/16.5 mm	100
16363	641300163639		large	black				
16364	641300163646	<b>stamp 2 (small)</b>	small	raw silver	439g	die cast aluminum	13.5/16.5 mm	100
16365	641300163653		small	black				
16267	641300162670	<b>stamp 1 (large)</b>	large	black	329g	composite	13mm	50
16268	641300162687		large	red				
16269	641300162694		large	blue				
16388	641300163882		large	orange				
16270	641300162700	<b>stamp 1 (small)</b>	small	black	299g	composite	13mm	50
16271	641300162717		small	red				
16272	641300162724		small	blue				
16392	641300163929		small	orange				

(\*) Tutti i pesi sono intesi per coppia di pedali | Tous les poids indiqués sont par paire de pédales



## STAMP 1 GEN 2 | KEY FEATURES

- Taglia specifica Small/Large per un'interfaccia ottimale tra scarpa e pedale
- Corpo in materiale composito rinforzato leggero, migliora la flessione e riduce il possibile incastrò del pedale nei colpi di roccia
- Piattaforma concava per una presa sicura (spessore di 13,5-15,5 mm)
- 10 pin sostituibili
- Cuscinetti e sistema di tenuta di alta qualità (gli stessi del modello Stamp 7)
- Cuscinetti igus LL-glide (interni ed esterni)
- Perno in acciaio cromato forgiato SCM 435
- Riparabile
- Garanzia di 5 anni

### GRIP:

- Piattaforma concava per una presa sicura (spessore di 13,5-15,5 mm)
- 10 pin sostituibili per lato

### DURATA:

- Nuova struttura per rinforzare il perno e ridurre i possibili incastrò del pedale nei colpi di roccia
- Componenti interni premium del modello Stamp 7 per una migliore tenuta e durata

- Taille spécifique Small/Large pour une interface optimale entre la chaussure et la pédale
- Le corps en composite renforcé est léger, améliore la déflexion et réduit l'accrochage lors des chocs avec les pierres
- Plateforme concave pour un maintien du pied sûr (13,5-15,5 mm d'épaisseur)
- 10 picots de traction remplaçables
- Roulements et systèmes d'étanchéité premium (mêmes composants internes que les Stamp 7)
- Roulements igus LL-glide (intérieurs et extérieurs)
- Axe en acier chromoly forgé SCM 435
- Réparable
- Garantie 5 ans

### ACCROCHE :

- Plateforme concave pour un maintien du pied sûr (13,5-15,5 mm d'épaisseur)
- 10 picots de traction remplaçables par côté

### DURABILITÉ :

- Nouvelle forme du corps pour renforcer l'axe et réduire l'accrochage lors des chocs avec les rochers
- Composants internes premium des Stamp 7 pour une meilleure étanchéité et une plus grande durabilité

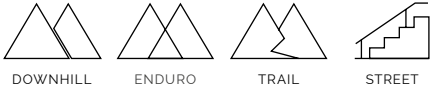

# FLAT PEDALS STAMP 1 GEN 2

**NEW**



ARTICLE	UPC	NEW	MODEL	SIZE	BODY COLOR	WEIGHT*	BODY MATERIAL	THICKNESS	PRICE (€)
16809	641300168092	<b>NEW</b>	<b>stamp 1 - GEN 2 (large)</b>	large	black	348g	reinforced composite	13.5/15.5mm	60
16811	641300168115	<b>NEW</b>		large	red				60
16813	641300168139	<b>NEW</b>		large	orange				60
16815	641300168153	<b>NEW</b>		large	navy blue				60
16817	641300168177	<b>NEW</b>		large	purple				60
16810	641300168108	<b>NEW</b>	<b>stamp 1 - GEN 2 (small)</b>	small	black	299g	reinforced composite	13.5/15.5mm	60
16812	641300168122	<b>NEW</b>		small	red				60
16814	641300168146	<b>NEW</b>		small	orange				60
16816	641300168160	<b>NEW</b>		small	navy blue				60
16818	641300168184	<b>NEW</b>		small	purple				60

(\*) Tutti i pesi sono intesi per coppia di pedali | Tous les poids indiqués sont par paire de pédales

# PEDALS ACCESSORIES

## CLEAT COLLECTION

STANDARD RELEASE 6° FLOAT CLEAT



GOLD

RELEASE: 15°      FLOAT: 6°

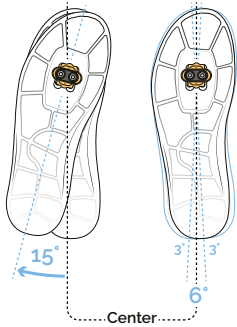

STANDARD RELEASE 0° FLOAT CLEAT



SILVER

RELEASE: 15°      FLOAT: 0°

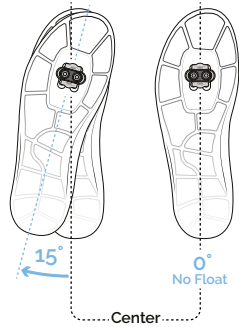

EASY RELEASE 6° FLOAT CLEAT



ROSE

RELEASE: 10°      FLOAT: 6°

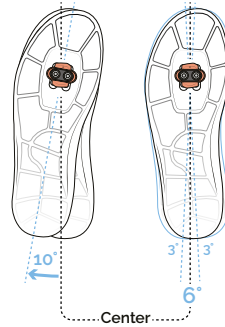

EASY RELEASE 0° FLOAT CLEAT



BRONZE

RELEASE: 10°      FLOAT: 0°

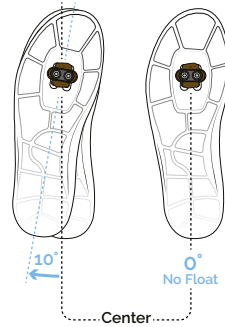

## CLEAT POP KIT (INCLUDES 16 PAIRS OF CLEATS)



ARTICLE	UPC	MODEL	PRICE (€)
10060	641300600127	cleat standard release 6 degree	27
15338	641300153388	cleat standard release 0 degree	27
16275	641300162755	cleat easy release 6 degree	27
16276	641300162762	cleat easy release 0 degree	27
16351	641300163516	cleat kit 16 units with fitting tool and display FRENCH	-
16354	641300163547	cleat kit 16 units with fitting tool and display ITALIAN	-



## PEDALS ACCESSORIES

### CLEAT AND PEDAL ACCESSORIES



MATCH SHOE  
SHIM



METAL SHOE  
SHIELDS



3 HOLE ROAD  
CLEAT



CANDY 7/11  
TRACTION PADS



CANDY 2/3 TRACTION PADS  
2017 - 2018



CANDY 2/3/11  
TRACTION PADS  
2010 - 2016



MALLET E/DH  
TRACTION PADS



EGGBEATER 1mm  
TRACTION PAD

### REFRESH KIT COLLECTION



LONG SPINDLE KIT



TITANIUM SPINDLE KIT



REFRESH KIT



REFRESH KIT  
EGGBEATER 11 / CANDY 11



REFRESH KIT  
STAMP 7 / 11



REFRESH KIT  
DOUBLE SHOT 2 / 3



10MM PIN KIT



8MM PIN KIT

ARTICLE	UPC	COLLECTION	MODEL	PRICE (€)
16685	641300166852	cleat and pedal accessories	match shoe shim	5
10000	641300670007		metal shoes shields/pair	10
15289	641300152893		3 hole cleat kit	30
16057	641300160577		candy 7/11 traction pads	15
16217	641300162175		candy 2/3 traction pads (model 2017)	10
13282	641300132826		candy 2/3/11 traction pads (model 2010-2016)	10
16058	641300160584		mallet e/dh traction pads	15
16509	641300165091		eggbeater 1mm traction pad	10
16067	641300160676	refresh kit collection	long spindle kit	50
16068	641300160683		titanium spindle kit	180
16051	641300160515		refresh kit 2010-present	29
16229	641300162298		refresh kit eggbeater / candy 11	29
16273	641300162731		refresh kit stamp 7/11	25
16274	641300162748		refresh kit double shot 2/3	30
13890	641300138903		flats 10mm pin kit	12
13891	641300138910		flats 8mm pin kit	12





## FOOTWEAR

# THE CRANKBROTHERS SHOE COLLECTION

LA NUOVA LINEA DI SCARPE E' STATA PROGETTATA CON UN SOLO OBIETTIVO: MIGLIORARE L'ESPERIENZA IN BICI DI OGNI RIDER. ASSECONDANDO LE RICHIESTE PIU' COMUNI RICERCATE SULLE CALZATURE ESISTENTI, QUESTE NUOVE SCARPE SONO STATE DISEGNATE PER OFFRIRE IL PERFETTO BILANCIAMENTO TRA UN'INTERFACCIA OTTIMALE SCARPA-PEDALE CON I REQUISITI RICHIESTI QUANDO SI SCENDE DI BICI.

LA NOUVELLE GAMME DE CHAUSSURES A ÉTÉ CONÇUE AVEC UN SEUL OBJECTIF - CRÉER LA CHAUSSURE VTT LA PLUS ABOUTIE POUR TRAIL ET GRAVITY. PAR RAPPORT AUX MULTIPLES PROBLÈMES COURAMMENT RENCONTRES AVEC LES CHAUSSURES EXISTANTES, ELLES ONT ÉTÉ CONÇUES AFIN D'OFFRIR L'ÉQUILIBRE PARFAIT D'INTERFACE CHAUSSURE-PÉDALE OPTIMISÉE AVEC DES CARACTÉRISTIQUES POUR LA PRATIQUE OFFROAD.



# MATCH SYSTEM



## PER ABBINARE IL PEDALE CON LA SCARPA POUR ACCOUPLER LA PÉDALE À LA CHAUSSURE

MATCH È UN APPROCCIO DI DESIGN INTEGRATO CHE CONSIDERA IL PEDALE E LA SCARPA  
COME UN SISTEMA UNICO CHE ASSICURA L'INTERFACCIA OTTIMALE.

MATCH EST UNE APPROCHE DE CONCEPTION INTÉGRÉE QUI CONSIDÈRE LA PÉDALE ET LA CHAUSSURE  
COMME UN SYSTÈME UNIFIÉ POUR FOURNIR L'INTERFACE OPTIMALE.

# MATCH SHIM CHART



SPD



CLEAT ONLY

CRANKBROTHERS

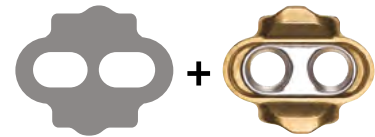

SHIM + CLEAT

**OTTIMIZZATO PER OGNI SISTEMA DI AGGANCO DELLE MTB**  
**OPTIMISÉ POUR TOUT SYSTÈME DE PÉDALES AUTOMATIQUES DE VTT**

INGAGGIO OTTIMIZZATO PER SISTEMI DI AGGANCO CRANKBROTHERS  
 INGAGGIO DUREVOLE CON I PEDALI CRANKBROTHERS

OPTIMISÉ POUR L'ENCLÈNCHÉMENT DES PÉDALES CRANKBROTHERS ENCLÈNCHÉMENT DURABLE  
 AVEC LES PÉDALES CRANKBROTHERS

SHIM THICKNESS CHART:		PEDALS			
GREY: 1.5mm BLACK: 1mm BLACK: 1mm		MALLET DH	MALLET E	MALLET TRAIL	CANDY
					<b>X</b>
<b>MALLET</b>		PRE-INSTALLED	PRE-INSTALLED	USE BLACK SHIM INCLUDED WITH PEDALS / USE #16917 (AVAILABLE SEPARATELY)	SHIM NOT RECOMMENDED
					<b>X</b>
<b>MALLET E</b>		PRE-INSTALLED	PRE-INSTALLED	USE BLACK SHIM INCLUDED WITH PEDALS / USE #16917 (AVAILABLE SEPARATELY)	SHIM NOT RECOMMENDED
<b>MALLET TRAIL</b>		INCLUDED IN SHOE PACKAGING	INCLUDED IN SHOE PACKAGING	PRE-INSTALLED	PRE-INSTALLED
		<b>X</b>	<b>X</b>		
<b>CANDY XC</b>		SHIM NOT RECOMMENDED	SHIM NOT RECOMMENDED	USE BLACK SHIM INCLUDED WITH PEDALS / USE #16917 (AVAILABLE SEPARATELY)	USE BLACK SHIM INCLUDED WITH PEDALS / USE #16917 (AVAILABLE SEPARATELY)

SHOES



# MATCH BOX



ACCESSO E USCITA FACILI  
ENCLÈNEMENT ET DÉENCLÈNEMENT FACILES

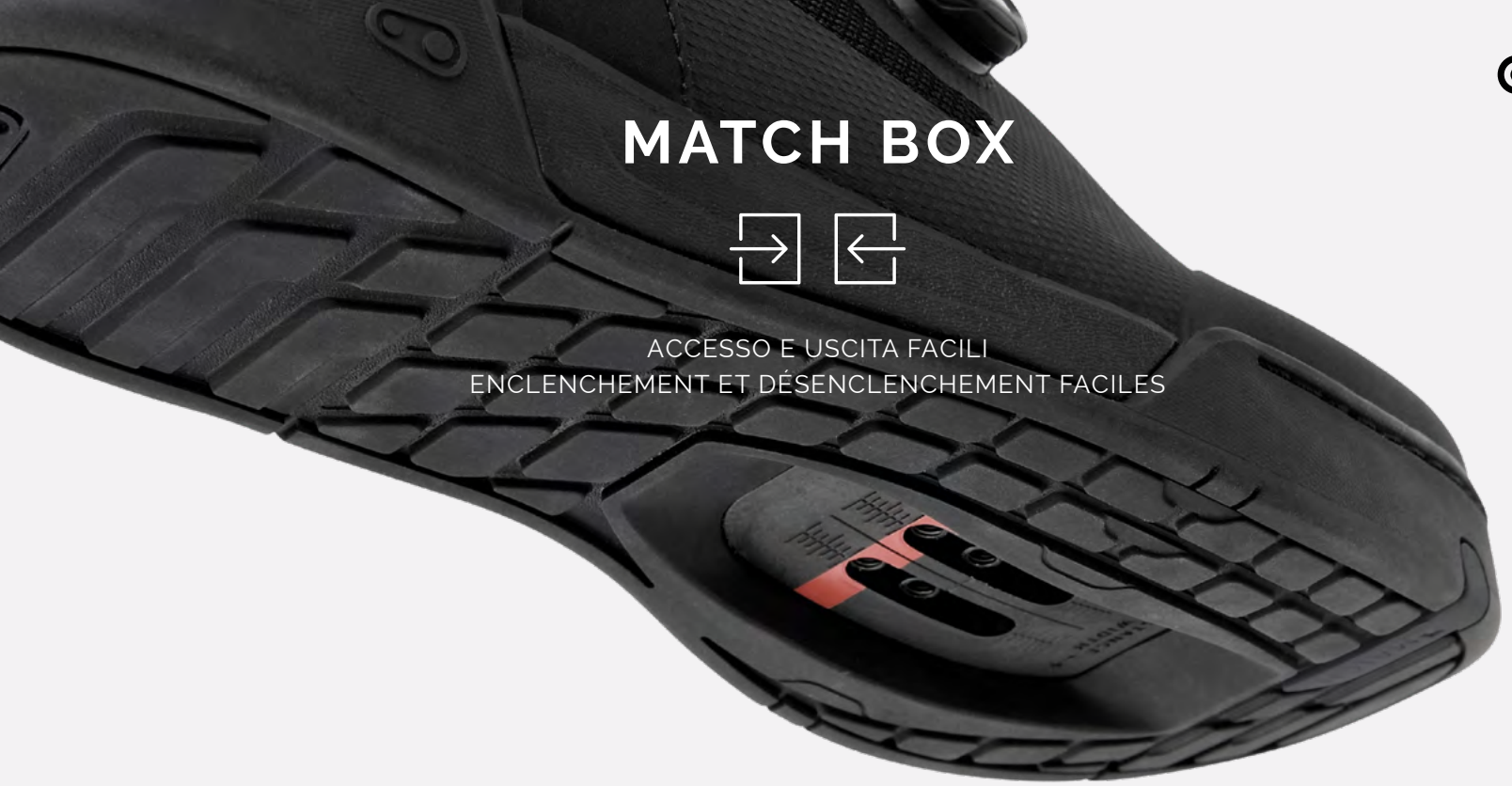

## PRONTI DA USARE | PRÊT À ROULER



ESPERIENZA D'ACQUISTO MIGLIORATA  
TACCHETTA PREINSTALLATA IN POSIZIONE NEUTRALE SU TUTTE LE SCARPE CLIP-IN  
AD ECCEZIONE DEL MODELLO CANDY

EXPÉRIENCE D'ACHAT AMÉLIORÉE  
LA CALE EST PRÉ-INSTALLÉE EN POSITION NEUTRE SUR TOUTES LES CHAUSSURES CLIP-IN,  
À L'EXCEPTION DU MODÈLE CANDY.

# TRAIL SHOES RANGE

## CARATTERISTICHE DELLA TOMAIA | CARACTERISTIQUES DE L'EMPEIGNE BOA SYSTEM E STRAP



## CLIP-IN OUTSOLE

### MATCH OUTSOLE

- Disegno del battistrada progettato per offrire trazione anche mentre si cammina
- Tacchetti sulla punta e sul tallone orientati in modo angolato e distanziato per garantire trazione durante le escursioni su terreni ripidi in salita o discesa
- Punta inclinata per una camminata migliore
- Struttura rigida in nylon rinforzato da fibra per un efficiente trasferimento di potenza
- Rivestimento in gomma della parte anteriore per una protezione extra della punta
- Motif de la bande de roulement conçu pour l'adhérence en dehors du vélo
- Les ergots directionnels angulaires et espacés au niveau des orteils et du talon offrent une bonne adhérence pour les randonnées sur terrains escarpés
- Bout en forme de rampe pour une marche facilité
- Tige rigide en nylon renforcé de fibres pour le transfert de puissance
- Caoutchouc enveloppé à l'avant pour une protection supplémentaire des orteils

### MATCH COMPOUND

- Composto in gomma mc1 a media aderenza che consente un facile inserimento e sgancio del pedale
- Resistenza migliorata all'usura e agli strappi
- Tacchetti arrotondati per diminuire l'abrasione
- Le composé de caoutchouc mc1 à friction moyenne facilite l'entrée et la sortie de la pédale
- Résistance accrue à l'usure et à la déchirure
- Cosses arrondies pour une meilleure résistance à l'abrasion





## CARATTERISTICHE DELLA TOMAIA | CARACTERISTIQUES DE L'EMPEIGNE LACE UP



## FLAT OUTSOLE



### MATCH OUTSOLE

- I tasselli profondi, posizionati in modo uniforme, sono progettati per garantire una presa sicura sui pin
- I tasselli della punta e del tallone sono inclinati e spaziosi in modo direzionale per offrire trazione durante la salita o la discesa su terreni ripidi
- Il disegno del battistrada è progettato per garantire trazione mentre si cammina
- La punta inclinata permette una camminata migliore
- Intersuola in Eva per smorzare le vibrazioni
- Rivestimento in gomma nella parte anteriore per una protezione extra delle dita dei piedi
- Les ergots profonds et régulièrement placés sont conçus pour sécuriser les picots
- Les ergots directionnels et espacés au niveau des orteils et du talon offrent l'adhérence pour les randonnées en terrain escarpé
- La bande de roulement est conçue pour la traction en dehors du vélo
- Le bout de la chaussure est arrondi pour faciliter la marche
- Semelle intermédiaire Eva pour amortir les vibrations
- Avant enveloppé en caoutchouc pour une protection supplémentaire des orteils

### MATCH COMPOUND

- La mescola è ottimizzata per una presa solida e una maggiore durata
- Ha un elevato grip per aderire al meglio al corpo del pedale e una bassa capacità di rimbalzo per smorzare le vibrazioni
- I tasselli sono arrotondati per resistere all'abrasione
- Composé optimisé pour l'adhérence et la durabilité
- Possède un fort coefficient de friction pour adhérer au corps de la pédale et de faibles propriétés de rebond pour amortir les vibrations
- Les ergots sont arrondis pour résister à l'abrasion

CLIP-IN SHOES  
**MALLET TRAIL BOA**

**NEW**



**MALLET TRAIL LACE**

**NEW**



ARTICLE	NEW	MODEL	STYLE	COLOR	OUSOLE	CLOSURE	SIZE	WEIGHT	PRICE (€)
MTB41080A	<b>NEW</b>	<b>mallet trail boa</b>	clip-in	black/gold	gum	boa + strap	37-49	410g (single - size 42)	220
MTL41010A	<b>NEW</b>			black/black	gum				170
MTL42095A	<b>NEW</b>	<b>mallet trail lace</b>	clip-in	white/purple	purple	lace	37-49	385g (single - size 42)	170
MTL44040A	<b>NEW</b>			blue/blue	gum				170

Tutti i modelli sono disponibili nelle taglie piene | Tous les modèles sont disponibles en tailles pleines



FLAT SHOES  
**STAMP TRAIL BOA**

**NEW**



**STAMP TRAIL LACE**

**NEW**



ARTICLE	NEW	MODEL	STYLE	COLOR	OUSOLE	CLOSURE	SIZE	WEIGHT	PRICE (€)
TRB41080A	<b>NEW</b>	<b>stamp trail boa</b>	flat	black/gold	gum	boa + strap	37-49	320g (single - size 42)	200
TRL41010A	<b>NEW</b>			black/black	gum				150
TRL42095A	<b>NEW</b>	<b>stamp trail lace</b>	flat	white/purple	purple	lace	35-49	295g (single - size 42)	150
TRL44040A	<b>NEW</b>			blue/blue	gum				150

Tutti i modelli sono disponibili nelle taglie piene | Tous les modèles sont disponibles en tailles pleines



# MALLET, MALLET E, STAMP RANGE

CARATTERISTICHE DELLA TOMAIA | CARACTERISTIQUES DE L'EMPEIGNE  
LACE UP



## MATERIALI PREMIUM MATÉRIAUX DE QUALITÉ SUPÉRIEURE

### TRASPIRABILITÀ/RESPIRABILITÉ

Materiali traforati e inserti ventilanti in mesh garantiscono massima traspirabilità.  
Les matériaux perforés et les ouvertures en mesh ventilé assurent la respirabilité.

### PROTEZIONE/PROTECTION

Punta realizzata in materiali rinforzati per protezione dagli impatti.  
Les matériaux renforcés au niveau des orteils offrent une protection contre les impacts.

### COMFORT/CONFORT

Linguetta e fodera tallone imbottite per massimo comfort durante tutta la giornata.  
La languette et les talons rembourrés offrent un confort tout au long de la journée et un ajustement supérieur.



## TRE TIPOLOGIE DI CHIUSURA TROIS OPTIONS DE FERMETURE

### **BOA® SYSTEM & STRAP**

Un rotore microregolabile, un robusto e leggero laccio e passanti a bassa frizione per ottenere una calzata veloce, comoda e precisa. Disegnato per consentire regolazioni indipendentemente dalle condizioni, il BOA® ti garantirà il controllo immediato sul tuo riding semplicemente con una mano, per una regolazione al volo.

Une molette de micro-adjustement, un lacet solide et léger et des guides de lacet à faible friction permettent un ajustement rapide, sans effort et précis. Conçu pour permettre des modifications de réglages quelles que soient les conditions, BOA® garantit que vous aurez un contrôle instantané tout en roulant, par un simple réglage d'une seule main.



### **SPEED LACE & STRAP**

Il sistema di chiusura con laccio rapido offre una regolazione facile, uno strap per una chiusura sicura e una tasca per alloggiare i lacci in sicurezza.

Le système de fermeture à lacets permet un ajustement rapide, une sangle procure une fermeture sécurisée et une poche afin de ranger les lacets en toute sécurité.



### **LACE UP**

La classica chiusura a laccio offre una ritenzione dolce con lacci rotondi e una tasca per alloggiarli in sicurezza.

Le système de fermeture classique à lacets ronds procure un serrage en douceur. Une poche permet de les ranger en toute sécurité.



CLIP-IN SHOES  
**MALLET BOA**



CLIP-IN SHOES  
**MALLET SPEEDLACE**





CLIP-IN SHOES  
**MALLET LACE**



**PUMPFORPEACE EDITION**



**SPLATTER EDITION**



**SPLATTER EDITION**

ARTICLE	MODEL	STYLE	COLOR	OUSOLE	CLOSURE	SIZE	WEIGHT	PRICE (€)
MAB01080A	<b>mallet boa</b>	clip-in	black/gold	black	boa + strap	37-49	429g (single - size 42)	200
MAS01020A	<b>mallet speedlace</b>	clip-in	black/white	black	speedlace + strap	37-48	428g (single - size 42)	170
MAL01030A	<b>mallet lace</b>	clip-in	black/red	black	lace	37-48	415g (single - size 42)	150
MAL13010A	<b>mallet lace pumpforpeace edition</b>	clip-in	red/black*	gum	lace	37-48	415g (single - size 42)	160
MAL17040S	<b>mallet lace splatter edition</b>	clip-in	grey/blue*	gum	lace	37-48	415g (single - size 42)	150
MAL15152S	<b>mallet lace splatter edition</b>	clip-in	petrol/lime*	gum	lace	37-48	415g (single - size 42)	150

Tutti i modelli sono disponibili nelle taglie piene | Tous les modèles sont disponibles en tailles pleines

(\*) Fino ad esaurimento scorte | Jusqu'à épuisement des stocks

CLIP-IN SHOES  
**MALLET E BOA**



CLIP-IN SHOES  
**MALLET E SPEEDLACE**





CLIP-IN SHOES  
**MALLET E LACE**



ARTICLE	MODEL	STYLE	COLOR	OUSOLE	CLOSURE	SIZE	WEIGHT	PRICE (€)
MEB01080A	<b>mallet e boa</b>	clip-in	black/gold*	black	boa + strap	37-48	439g (single - size 42)	200
MES05443A	<b>mallet e speedlace</b>	clip-in	green/blue*	gum	speedlace + strap	37-48	437g (single - size 42)	170
MEL01043A	<b>mallet e lace</b>	clip-in	black/blue*	black	lace	37-48	432g (single - size 42)	150

Tutti i modelli sono disponibili nelle taglie piene | Tous les modèles sont disponibles en tailles pleines

(\*) Fino ad esaurimento scorte | Jusqu'à épuisement des stocks

FLAT SHOES  
**STAMP BOA**



FLAT SHOES  
**STAMP SPEEDLACE**





FLAT SHOES  
**STAMP LACE**



**PUMPFORPEACE EDITION**



**SPLATTER EDITION**



**SPLATTER EDITION**

ARTICLE	MODEL	STYLE	COLOR	OUSOLE	CLOSURE	SIZE	WEIGHT	PRICE (€)
STB01080A	<b>stamp boa</b>	flat	black/gold	black	boa + strap	37-49	379g (single - size 42)	180
STS21020A			black/white	black				150
STS29546A	<b>stamp speedlace</b>	flat	purple/teal blue	gum	speedlace + strap	37-48	383g (single - size 42)	150
STS05435A			green/orange*	black				150
STS07030A			grey/red*	black				150
STL04281A			black/silver			35-48		130
STL02086A	<b>stamp lace</b>	flat	white/white	gum	lace	35-48	376g (single - size 42)	130
STL01081A			navy/silver			37-49		130
STL13010P	<b>stamp lace pumpforpace edition</b>	flat	red/black*	gum	lace	37-48	376g (single - size 42)	140
STL17040S	<b>stamp lace splatter edition</b>	flat	grey/blue*	gum	lace	37-48	376g (single - size 42)	130
STL15152S			petrol/lime*					130

Tutti i modelli sono disponibili nelle taglie piene | Tous les modèles sont disponibles en tailles pleines

(\*) Fino ad esaurimento scorte | Jusqu'à épuisement des stocks



FLAT SHOES  
**STAMP STREET LACE**



ARTICLE	MODEL	STYLE	COLOR	OUSOLE	CLOSURE	SIZE	WEIGHT	PRICE (€)
SSL11080F	<b>stamp street lace</b>	flat	black/gold	gum	lace	35-48	570g (single - size 42)	130
SSL12080F		white/gold						130

Tutti i modelli sono disponibili nelle taglie piene | Tous les modèles sont disponibles en tailles pleines



# CANDY GRAVEL / XC SHOE

CARATTERISTICHE DELLA TOMAIA | CARACTERISTIQUES DE L'EMPEIGNE

## LACE UP



LASER-CUT MATERIALS  
AND PERFORATED TONGUE  
FOR BREATHABILITY

LACE CLOSURE SYSTEM,  
WITH ELASTIC RETENTION LOOP  
TO KEEP THINGS IN CHECK

PU FILM FOR ABRASION  
RESISTANCE AND EASY  
CLEANING

TPU TOE  
PROTECTION



## CLIP-IN OUTSOLE

### MATCH OUTSOLE

- Suola in gomma e disegno del battistrada progettati per garantire trazione anche mentre si cammina
- Lungo canale centrale per un inserimento fluido del pedale e per facilitare la rimozione del fango
- Possibilità di scegliere la posizione ottimale delle tacchette grazie a una pista di 35 mm
- Zona antiscivolo nel caso in cui il pedale non venga agganciato
- La semelle extérieure en caoutchouc et la bande de roulement sont conçues pour la traction en dehors du vélo
- Long canal central pour un accès ininterrompu à la pédale et une évacuation de la boue
- Possibilité de choisir la position optimale de la cale grâce à un espace de cale étendu de 35 mm
- Zone antidérapante si vous ne vous engagez pas sur la pédale

### MATCH COMPOUND

- Il composto di gomma mc1 a media aderenza consente un facile inserimento e sgancio del pedale
- Resistenza migliorata all'usura e alle sollecitazioni
- Tacchetti arrotondati per resistere all'abrasione
- Le composé de caoutchouc mc1 à friction moyenne facilite l'entrée et la sortie de la pédale.
- Résistance accrue à l'usure et à la déchirure
- Cosses arrondies pour résister à l'abrasion





CLIP-IN SHOES

# CANDY GRAVEL / XC LACE

**NEW**



ARTICLE	NEW	MODEL	STYLE	COLOR	OUSOLE	CLOSURE	SIZE	WEIGHT	PRICE (€)
CGL41010A	<b>NEW</b>	<b>candy gravel/xc lace</b>	clip-in	black/black	gum	lace	37-49	340g (single - size 42)	160
CGL42070A	<b>NEW</b>			white/grey	grey				160

Tutti i modelli sono disponibili nelle taglie piene | Tous les modèles sont disponibles en tailles pleines

SOCKS  
**ICON MTB SOCKS**



WHITE / PURPLE



WHITE / RED / BLACK



BLACK / GOLD / GREY



BLACK / RED / GREY



WHITE / BROWN / BLACK



BLUE / WHITE

ARTICLE	UPC	NEW	MODEL	COLOR	SIZE	PRICE (€)
81333	641300813336	<b>NEW</b>	icon mtb sock	white/purple	small/medium	19,90
81334	641300813343	<b>NEW</b>		white/purple	large/x-large	19,90
81254	641300812544	<b>NEW</b>		white/red/black	small/medium	15,90
81255	641300812551	<b>NEW</b>		white/red/black	large/x-large	15,90
81223	641300812230			black/gold/grey	small/medium	15,90
81224	641300812247			black/gold/grey	large/x-large	15,90
81232	641300812322			black/red/grey*	small/medium	15,90
81230	641300812308			white/brown/black	small/medium	15,90
81231	641300812315			white/brown/black	large/x-large	15,90
81228	641300812285			navy blue/white	small/medium	15,90
81229	641300812292			navy blue/white	large/x-large	15,90

(\*) Fino ad esaurimento scorte | Jusqu'à épuisement des stocks



LACES

# BOA REPLACEMENT KIT

**NEW**



# SPEEDLACE

**NEW**



PINK



BLACK



RED



ORANGE



LIGHT BLUE



WHITE



SILVER

ARTICLE	UPC	NEW	MODEL	COLOR	SIZE	PRICE (€)
16751	641300167514	<b>NEW</b>	<b>BOA Li2 replacement kit</b>	black	TU	30,00
16638	641300166388		<b>BOA L6 replacement kit</b>	black	TU	22,00
16738	641300167385	<b>NEW</b>	<b>speedlace</b>	pink	TU	10,90
16639	641300166395			black	TU	10,90
16640	641300166401			red	TU	10,90
16641	641300166418			orange	TU	10,90
16642	641300166425			light blue	TU	10,90
16643	641300166432			white	TU	10,90
16644	641300166449			silver	TU	10,90

LACES  
**ROUNDED LACE**

**NEW**



PINK



BLACK



RED



ORANGE



LIGHT BLUE



WHITE



SILVER

ARTICLE	UPC	NEW	MODEL	COLOR	SIZE	PRICE (€)
16736	641300167361	<b>NEW</b>	<b>rounded lace</b>	pink	small/medium	5,90
16737	641300167378	<b>NEW</b>			large/x-large	5,90
16645	641300166456			black	small/medium	5,90
16657	641300166579				large/x-large	5,90
16646	641300166463			red	small/medium	5,90
16658	641300166586				large/x-large	5,90
16647	641300166470			orange	small/medium	5,90
16659	641300166593				large/x-large	5,90
16648	641300166487			light blue	small/medium	5,90
16660	641300166609				large/x-large	5,90
16649	641300166494			white	small/medium	5,90
16661	641300166616				large/x-large	5,90
16650	641300166500			silver	small/medium	5,90
16662	641300166623				large/x-large	5,90



LACES  
**FLAT LACE**

**NEW**



BLACK



WHITE



SAGE GREEN



SILVER



ORANGE



BLUE



PINK

ARTICLE	UPC	NEW	MODEL	COLOR	SIZE	PRICE (€)
16729	641300167293	<b>NEW</b>	flat lace	black	small/medium	5,90
16739	641300167392	<b>NEW</b>			large/x-large	5,90
16730	641300167309	<b>NEW</b>		white	small/medium	5,90
16740	641300167408	<b>NEW</b>			large/x-large	5,90
16731	641300167316	<b>NEW</b>		sage green	small/medium	5,90
16741	641300167415	<b>NEW</b>			large/x-large	5,90
16732	641300167323	<b>NEW</b>		silver	small/medium	5,90
16742	641300167422	<b>NEW</b>			large/x-large	5,90
16733	641300167330	<b>NEW</b>		orange	small/medium	5,90
16743	641300167439	<b>NEW</b>			large/x-large	5,90
16734	641300167347	<b>NEW</b>		blue	small/medium	5,90
16744	641300167446	<b>NEW</b>			large/x-large	5,90
16735	641300167354	<b>NEW</b>		pink	small/medium	5,90
16745	641300167453	<b>NEW</b>			large/x-large	5,90





WHEELS

# SYNTHESIS

TUNED WHEEL  
SYSTEM

LE RUOTE SYNTHESIS CARBON HANNO UNA GARANZIA A VITA.  
DETTAGLI SU [CRANKBROTHERS.COM](https://www.crankbrothers.com)

LES ROUES SYNTHESIS CARBON OFFRENT UNE GARANTIE À VIE.  
POUR PLUS D'INFORMATIONS ALLEZ SUR [CRANKBROTHERS.COM](https://www.crankbrothers.com)



ANTERIORE E POSTERIORE SPECIFICI | AVANT ET ARRIERE SPECIFIQUES

## UN SISTEMA RUOTA PERSONALIZZATO PAIRE DE ROUES PERSONNALISEES

### STRUTTURA RUOTA ANTERIORE

- Ridotto numero di raggi
- Tensione sui raggi inferiore
  - Raggi alleggeriti
  - Cerchio alleggerito
- Canale del cerchio più largo

### STRUCTURE ROUE AVANT

- Nombre de rayons réduit
- Tension des rayons inférieure
  - Rayons allégés
  - Jante allégée
- Profil intérieur de la jante plus large

### STRUTTURA RUOTA POSTERIORE

- Maggiore numero di raggi
- Tensione sui raggi maggiore
- Maggiore robustezza del raggio
  - Cerchio più resistente
- Canale del cerchio più stretto

### STRUCTURE ROUE ARRIÈRE

- Nombre de rayons plus élevés
- Tension des rayons supérieure
  - Rayons renforcés
  - Jante plus résistante
- Profil intérieur de la jante plus étroit

CONTROLLO NELLE CURVE | MAITRISE EN COURBE

## UNA RUOTA ANTERIORE MANEGGEVOLE ROUE AVANT PLUS MANIABLE



### MANEGGEVOLEZZA OTTIMIZZATA

- Smorza le vibrazioni sui trail
- Riduce la stanchezza del biker
- Attutisce e assorbe gli impatti

### CONDUITE PLUS MANIABLE

- Amortit les vibrations
- Réduit la fatigue du pilote
- Diminue et absorbe les chocs



### TRAIETTORIE SICURE

- Migliora l'aderenza
- Migliora l'ingresso in curva in velocità
- Tiene la copertura attaccata al suolo

### TRAJECTOIRES MAITRISEES

- Améliore l'adhérence
- Améliore la vitesse en courbe
- Maintient l'accroche du pneu au sol



### CANALE DEL CERCHIO A LARGHEZZA MAGGIORATA

- Aumenta il volume d'aria della copertura per una migliore aderenza
- Il profilo arrotondato della copertura migliora le sterzate
- Supporta le coperture di grossa sezione sull'anteriore

### PROFIL INTÉRIEUR DE LA JANTE PLUS LARGE

- Augmentation du volume d'air du pneu améliorant l'adhérence
- Le profil arrondi du pneu facilite le guidage en virage
- Supporte le montage de pneus de grosse section sur la roue avant

STABILITÀ E CONTROLLO IN VELOCITÀ | STABILITÉ ET CONTRÔLE À VITESSE ÉLEVÉE

## UNA RUOTA POSTERIORE RIGIDA UNE ROUE ARRIERE RIGIDE

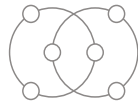

### CARICHI DIREZIONALI / RADIALI TOLLERATI PERFETTAMENTE

- Reattività
- Mantiene velocità e momento di inerzia
  - Stabilità
- Tollera le compressioni
- Ancora il biker al centro di gravità

### SUPPORTE PARFAITEMENT LES CHARGES DIRECTIONNELLES ET RADIALES

- Réactivité
- Vitesse maintenue et moment d'inertie
  - Stabilité
- Absorbe les pics de compression
- Maintient le centre de gravité du pilote



### CANALE DEL CERCHIO PIÙ STRETTO

- Riduce le pizzicature
- Migliora la resistenza al rotolamento
- Tassellatura più pronunciata per l'aderenza

### PROFIL INTÉRIEUR DE LA JANTE PLUS ÉTROIT

- Réduit la zone de contact
- Diminue la résistance au roulement
- Améliore l'adhérence du pneu

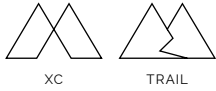

# CARBON WHEELSETS

## SYNTHESIS XCT 11

PRECISA IN VELOCITÀ | GUIDAGE PRECIS A HAUTE VITESSE

### HUB

SYNTHESIS 11 (INDUSTRY NINE HYDRA HUB)

### ENGAGEMENT

0.52" QUICK ENGAGEMENT / SIX PAWLS

### SPOKES

SAPIM CX-RAY (FRONT)

SAPIM CX-RAY (REAR)



FRONT



REAR

#### COMPLIANT FRONT WHEEL

SPOKE COUNT: 28  
INNER RIM WIDTH: 26.5

#### STIFF REAR WHEEL

SPOKE COUNT: 32  
INNER RIM WIDTH: 24.5

#### OUTER RIM WIDTH

OUTER RIM WIDTH FRONT: 31.1 MM  
REAR: 29.5 MM

ARTICLE	UPC	MODEL	DIAMETER	HUB	DRIVER BODY	FRONT AXLE	REAR AXLE	RIM	WEIGHT	PRICE (€)
16299	641300162991	synthesis xct 11	29"	boost i9	xd	110x15 mm	148x12 mm	carbon premium	1519g	2400
16464	641300164643		29"	boost i9	shimano micro spline	110x15 mm	148x12 mm	carbon premium	1764g	2400

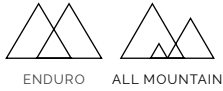

CARBON WHEELSETS  
**SYNTHESIS E 11**

CONTROLLO E STABILITÀ PER L'ENDURO | CONTRÔLE ET STABILITÉ EN PRATIQUE ENDURO

**HUB**  
INDUSTRY NINE HYDRA HUB

**ENGAGEMENT**  
0.52" QUICK ENGAGEMENT / SIX PAWLS

**SPOKES**  
SAPIM CX-RAY (FRONT)  
SAPIM CX-SPRINT (REAR)



FRONT



REAR

COMPLIANT FRONT WHEEL

SPOKE COUNT: 28  
INNER RIM WIDTH: 31.5

STIFF REAR WHEEL

SPOKE COUNT: 32  
INNER RIM WIDTH: 29.5

OUTER RIM WIDTH

OUTER RIM WIDTH FRONT: 37.5 MM  
OUTER RIM WIDTH REAR: 36.5 MM

ARTICLE	UPC	MODEL	DIAMETER	HUB	DRIVER BODY	FRONT AXLE	REAR AXLE	RIM	WEIGHT	PRICE (€)
16448	641300164483	<b>synthesis e 11</b>	27.5"	boost i9	shimano micro spline	110x15 mm	148x12 mm	carbon premium	1760g	2400
16449	641300164490		27.5"	super boost 157 i9	xd	110x15 mm	157x12mm	carbon premium	1760g	2400
16454	641300164544		29"	boost i9	shimano micro spline	110x15 mm	148x12 mm	carbon premium	1825g	2400
16455	641300164551		29"	super boost 157 i9	xd	110x15 mm	157x12mm	carbon premium	1825g	2400
16446	641300164469		27.5"	boost i9	xd	110x15 mm	148x12 mm	carbon premium	1760g	2400
16452	641300164520		29"	boost i9	xd	110x15 mm	148x12 mm	carbon premium	1825g	2400



# CARBON SINGLE WHEEL SYNTHESIS GRAVEL CARBON

**NEW**

DOVE IL COMFORT INCONTRA LA PERFORMANCE | QUAND LE CONFORT RENCONTRE LA PERFORMANCE

**HUB**  
SYNTHESIS RATCHET

**ENGAGEMENT**  
10°

**SPOKES**  
SAPIM D-LIGHT

**SIZES**  
700 C / 650 B

**WEIGHT**  
700 C: 1544g / 650 B: 1517G

TUBELESS READY



FRONT

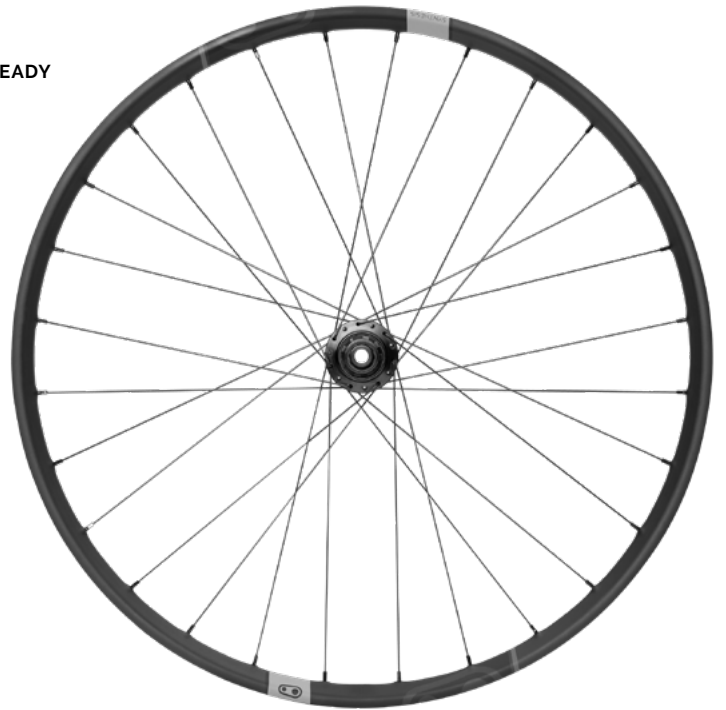

REAR

FRONT WHEEL

SPOKE COUNT: 28  
INNER RIM WIDTH: 26.5

REAR WHEEL

SPOKE COUNT: 28  
INNER RIM WIDTH: 26.5

ARTICLE	UPC	NEW	MODEL	DIAMETER	HUB	DRIVER BODY	FRONT AXLE	REAR AXLE	RIM	WEIGHT	PRICE (€)
16825	641300168252	<b>NEW</b>	synthesis gravel carbon	<b>700c front</b>	CB ratchet	-	12X100 mm	-	26.5mm	716g	600
16826	641300168269	<b>NEW</b>		<b>700c rear</b>	CB ratchet	XDR	-	142x12 mm	26.5mm	833g	900
16827	641300168276	<b>NEW</b>		<b>700c rear</b>	CB ratchet	HG	-	142x12 mm	26.5mm	836g	900
16828	641300168283	<b>NEW</b>		<b>650b front</b>	CB ratchet	-	12X100 mm	-	26.5mm	698g	600
16829	641300168290	<b>NEW</b>		<b>650b rear</b>	CB ratchet	XDR	-	142x12 mm	26.5mm	819g	900
16830	641300168306	<b>NEW</b>		<b>650b rear</b>	CB ratchet	HG	-	142x12 mm	26.5mm	826g	900



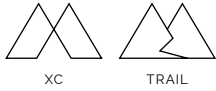

# ALLOY SINGLE WHEEL SYNTHESIS XCT ALLOY

PRECISA IN VELOCITÀ | GUIDAGE PRECIS A HAUTE VITESSE

**HUB**  
SYNTHESIS STANDARD HUB

**ENGAGEMENT**  
4'

**SPOKES**  
SAPIM D-LIGHT (FRONT)  
SAPIM RACE (REAR)



FRONT



REAR

COMPLIANT FRONT WHEEL

SPOKE COUNT: 28    INNER RIM WIDTH: 26.5

STIFF REAR WHEEL

SPOKE COUNT: 32    INNER RIM WIDTH: 24.5

ARTICLE	UPC	MODEL	DIAMETER	DRIVER BODY	HUB	FRONT AXLE	REAR AXLE	RIM	WEIGHT	PRICE (€)
16418	641300164186	synthesis alloy xct	29" front	-	boost	110x15 mm	148x12 mm	aluminum	841g	240
16419	641300164193		29" rear	xd	boost	110x15 mm	148x12 mm	aluminum	998g	360
16421	641300164216		29" rear	shimano micro spline	boost	110x15 mm	148x12 mm	aluminum	998g	360



ALLOY SINGLE WHEEL  
**SYNTHESIS E ALLOY**

CONTROLLO E STABILITÀ PER L'ENDURO | CONTRÔLE ET STABILITÉ EN PRATIQUE ENDURO

**HUB**  
 SYNTHESIS STANDARD HUB

**ENGAGEMENT**  
 4°  
 17°

**SPOKES**  
 SAPIM D-LIGHT (FRONT)  
 SAPIM RACE (REAR)



FRONT



REAR

COMPLIANT FRONT WHEEL

SPOKE COUNT: 28    INNER RIM WIDTH: 31.5

STIFF REAR WHEEL

SPOKE COUNT: 32    INNER RIM WIDTH: 29.5

ARTICLE	UPC	MODEL	DIAMETER	DRIVER BODY	HUB	FRONT AXLE	REAR AXLE	RIM	WEIGHT	PRICE (€)
16406	641300164063	synthesis alloy enduro	<b>27.5" front</b>	-	boost	110x15 mm	148x12 mm	aluminum	877g	240
16407	641300164070		<b>27.5" rear</b>	xd	boost	110x15 mm	148x12 mm	aluminum	1062g	360
16409	641300164094		<b>27.5" rear</b>	shimano micro spline	boost	110x15 mm	148x12 mm	aluminum	1062g	360
16410	641300164100		<b>29" front</b>	-	boost	110x15 mm	148x12 mm	aluminum	902g	240
16411	641300164117		<b>29" rear</b>	xd	boost	110x15 mm	148x12 mm	aluminum	1095g	360
16413	641300164131		<b>29" rear</b>	shimano micro spline	boost	110x15 mm	148x12 mm	aluminum	1095g	360





ELECTRIC

# ALLOY SINGLE WHEEL SYNTHESIS E-BIKE ALLOY

COSTRUITA PER E-MTB | CONSTRUIT POUR E-MTB

## HUB

SYNTHESIS STANDARD HUB

## ENGAGEMENT

17'

## SPOKES

S APIM E-LIGHT (FRONT)

S APIM STRONG (REAR)



FRONT



REAR

SIZES: 27.5 - 29

SIZE: 27.5+

COMPLIANT FRONT WHEEL

STIFF REAR WHEEL

COMPLIANT FRONT WHEEL

STIFF REAR WHEEL

SPOKE COUNT:  
28

INNER RIM  
WIDTH:  
31.5

SPOKE COUNT:  
32

INNER RIM  
WIDTH:  
31.5

SPOKE COUNT:  
28

INNER RIM  
WIDTH:  
35.5

SPOKE COUNT:  
32

INNER RIM  
WIDTH:  
35.5

ARTICLE	UPC	MODEL	DIAMETER	DRIVER BODY	HUB	FRONT AXLE	REAR AXLE	RIM	WEIGHT	PRICE (€)
16422	641300164223	synthesis alloy e-mtb	<b>27.5" plus/front</b>	-	boost	110x15 mm	148x12 mm	aluminum	928g	300
16423	641300164230		<b>27.5" plus/rear</b>	xd	boost	110x15 mm	148x12 mm	aluminum	1181g	400
16425	641300164254		<b>27.5" plus/rear</b>	shimano micro spline	boost	110x15 mm	148x12 mm	aluminum	1181g	400
16426	641300164261		<b>29" front</b>	-	boost	110x15 mm	148x12 mm	aluminum	980g	300
16427	641300164278		<b>29" rear</b>	xd	boost	110x15 mm	148x12 mm	aluminum	1238g	400
16429	641300164292		<b>29" rear</b>	shimano micro spline	boost	110x15 mm	148x12 mm	aluminum	1238g	400



ALLOY SINGLE WHEEL

# SYNTHESIS GRAVEL ALLOY

**NEW**

DOVE IL COMFORT INCONTRA LA PERFORMANCE | QUAND LE CONFORT RENCONTRE LA PERFORMANCE

**HUB**  
SYNTHESIS STANDARD

**ENGAGEMENT**  
17°

**SPOKES**  
SAPIM D-LIGHT

**SIZES**  
700 C / 650 B

**WEIGHT**  
700 C: 1917g / 650 B: 1769g

TUBELESS READY

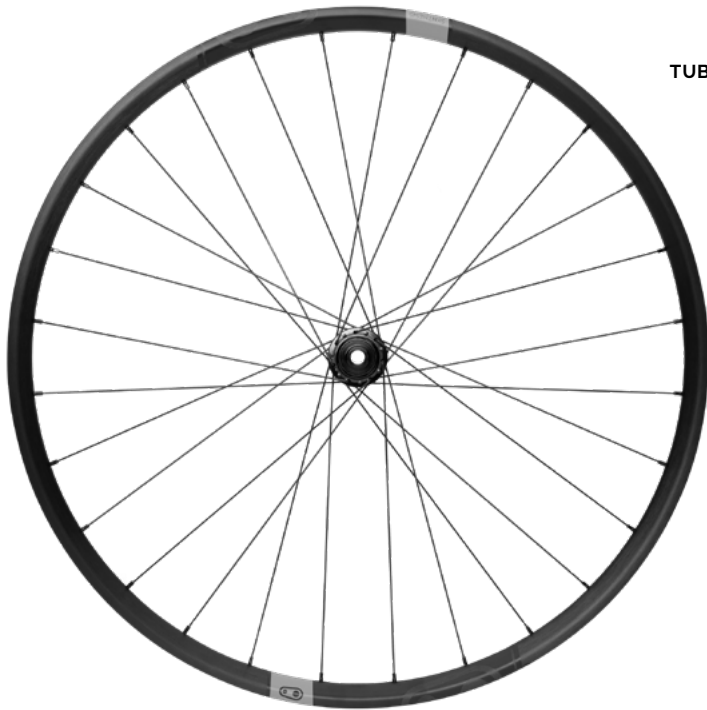

FRONT



REAR

FRONT WHEEL

SPOKE COUNT: 28  
INNER RIM WIDTH: 26.5

REAR WHEEL

SPOKE COUNT: 28  
INNER RIM WIDTH: 26.5

ARTICLE	UPC	NEW	MODEL	DIAMETER	HUB	DRIVER BODY	FRONT AXLE	REAR AXLE	RIM	WEIGHT	PRICE (€)
16831	641300168313	<b>NEW</b>		<b>700c front</b>	CB ratchet	-	12X100 mm	-	26.5mm	869g	240
16832	641300168320	<b>NEW</b>		<b>700c rear</b>	CB ratchet	XDR	-	142X12 mm	26.5mm	1050g	360
16833	641300168337	<b>NEW</b>	synthesis alloy gravel	<b>700c rear</b>	CB ratchet	HG	-	142X12 mm	26.5mm	1058g	360
16834	641300168344	<b>NEW</b>		<b>650b front</b>	CB ratchet	-	12X100 mm	-	26.5mm	792g	240
16835	641300168351	<b>NEW</b>		<b>650b rear</b>	CB ratchet	XDR	-	142X12 mm	26.5mm	977g	360
16836	641300168368	<b>NEW</b>		<b>650b rear</b>	CB ratchet	HG	-	142X12 mm	26.5mm	985g	360

## PIÙ VELOCE PER UNA ACCELERAZIONE PIÙ RAPIDA PLUS RAPIDE POUR UNE PLUS FORTE ACCELERATION



**BASSA INERZIA DI ROTAZIONE.** Ruote dal design unico, la massa è distribuita più vicino al mozzo, così da garantire più velocità in accelerazione e decelerazione.

**TUBELESS READY.** Il cerchio hole-less è più forte e non ha bisogno del rim tape per il montaggio dei tubeless.

**FAIBLE INERTIE DE ROTATION.** Conception de roue unique, distribue la masse au plus prêt du moyeu augmentant la rapidité d'accélération et de décélération.

**TUBELESS PRÊT.** Pas de trous de jantes, augmentant ainsi la résistance et pas de fond de jante nécessaire pour le montage de pneus tubeless.

## ROBUSTO E RIGIDO ROBUSTE ET PLUS RIGIDE

**TECNOLOGIA RAGGI TWINPAIR.** Progettata utilizzando la forma più resistente, il triangolo, per aumentare resistenza e rigidità.

**MERAVIGLIOSAMENTE SEMPLICE.** Raggi di un'unica lunghezza: facili da rimuovere e da sostituire senza dover togliere il copertone.

**MONTAGE RAYONS "TWIN PAIR".** Conçu en utilisant le montage rayons en triangle afin d'optimiser résistance et rigidité.

**MERVEILLEUSEMENT SIMPLE.** Une seule longueur de rayon facilitant le remplacement sans démonter le pneu.

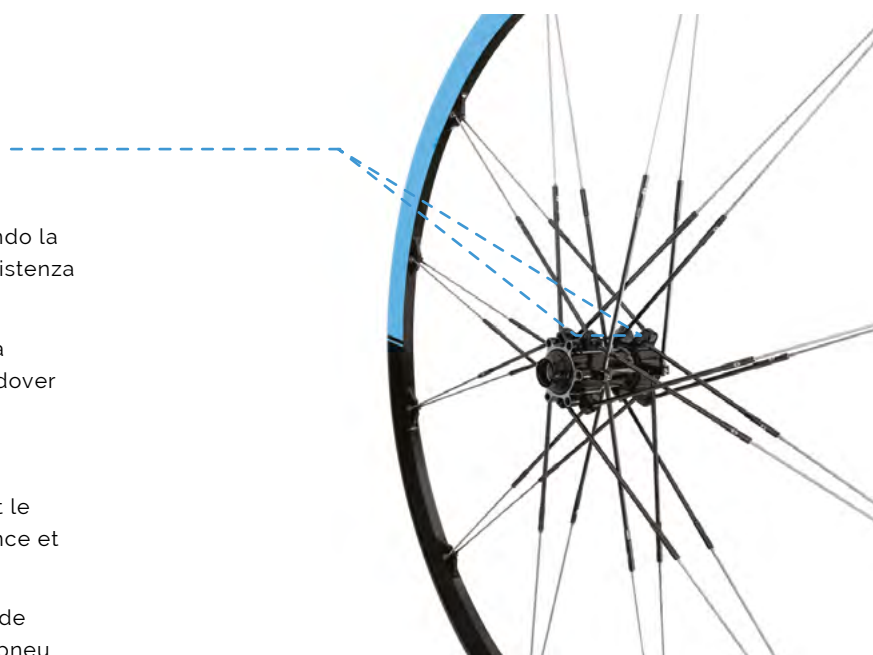

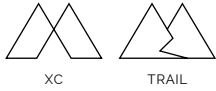

## ALLOY WHEELSETS

### COBALT

**2** COBALT 2  
ALUMINUM

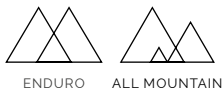
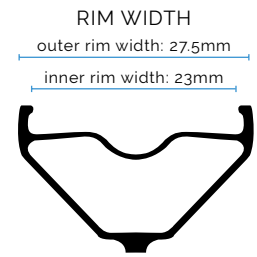

### IODINE

**2** IODINE 2  
ALUMINUM

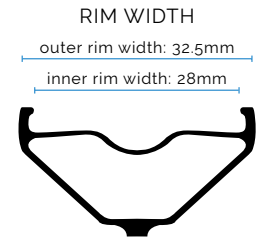

### ZINC

**3** ZINC 3  
ALUMINUM

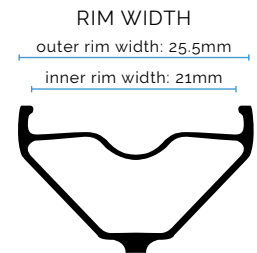
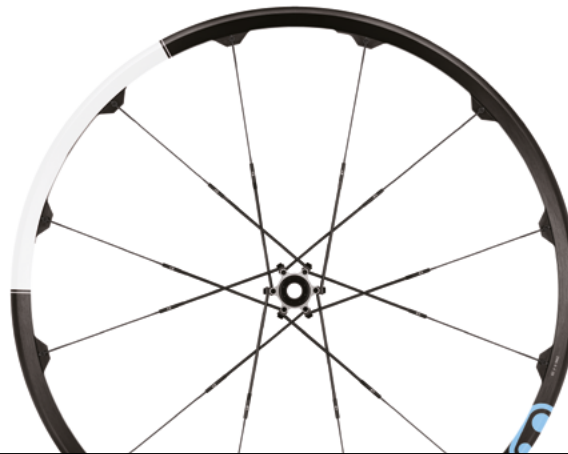

ARTICLE	UPC	MODEL	DIAMETER	HUB	DRIVER BODY	FRONT AXLE	REAR AXLE	COLOR	WEIGHT	PRICE (€)
16140	641300161406	<b>cobalt 2</b>	<b>29"</b>	standard	shimano hg	100x15 mm	142x12 mm	black/grey	1735g	600
16143	641300161437	<b>iodine 2</b>	<b>29"</b>	boost	-	110x15 mm	148x12 mm	black/grey	1900g	600
16145	641300161451		<b>27.5"</b>	boost	-	110x15 mm	148x12 mm	black/grey	1830g	600
16139	641300161390	<b>zinc 3</b>	<b>29"</b>	standard	shimano hg	100x15 mm	142x12 mm	black/white	1645g	800



## GRIPS COBALT

COBALT  
GRIPS

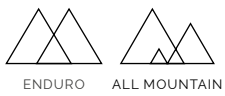

## IODINE

IODINE  
GRIP



ARTICLE	UPC	MODEL	COLOR	material	WIDTH	WEIGHT	PRICE (€)
15279	641300152794		silver				30
14918	641300149183	<b>cobalt grips</b>	gold	High density foam	130mm	67g	30
14919	641300149190		red				30
14920	641300149206	<b>iodine grip</b>	black	Krayton rubber	130mm	95g	30



## WHEELSETS ACCESSORIES



**XD DRIVER BODY**  
SYNTHESIS & ALLOY WHEELSETS



**WHEEL END CAP KIT (FRONT)**  
COBALT / IODINE / ZINC  
9mm



**WHEEL END CAP + AXLE KIT (FRONT)**  
COBALT / IODINE / ZINC  
100mm x 12mm



**WHEEL END CAP KIT (FRONT)**  
COBALT / IODINE / ZINC  
15mm



**WHEEL END CAP KIT (REAR)**  
COBALT / IODINE (LEVEL 3 & 11)  
135mm x 10mm



**WHEEL END CAP KIT (REAR)**  
COBALT / IODINE (LEVEL 3 & 11)  
142mm x 12mm

ARTICLE	UPC	COLLECTION	MODEL KIT	PRICE (€)
15538	641300155382	<b>wheelsets accessories</b>	wheel synthesis and alloy xd driver body for: level 2,3 e 11 (from range 2017)	100
99202	641300992024		wheel end cap kit for: cobalt / iodine / zinc > front 9mm	20
99203	641300992031		wheel end cap kit for: cobalt / iodine / zinc > front 15mm	20
99204	641300992048		wheel end cap kit for: cobalt / iodine level 3/11 > rear 135x10 mm	20
99205	641300992055		wheel end cap kit for: cobalt / iodine level 3/11 > rear 142x12 mm	20
99162	641300991621		wheel end cap + axle kit for: cobalt / iodine / zinc > front 100x12 mm	30



**DROPPER SEATPOST**

## **HIGHLINE DROPPER SEATPOST**

IL NOSTRO REGGISSELLA TELESCOPICO CON PESO PIU' CONTENUTO,  
GRAZIE AI SUOI MATERIALI PREMIUM CHE RISPARMIANO GRAMMI.

LA PLUS LÉGÈRE DE NOS TIGES DE SELLE RÉALISÉE À PARTIR DE MATÉRIAUX  
DE HAUTE QUALITÉ POUR UN GAIN DE POIDS MAXIMUM.



## DROPPER SEATPOST

# HIGHLINE 11 DROPPER SEATPOST

GUARNIZIONI PREMIUM TRELLEBORG, ESCLUSIVI CUSCINETTI E CALOTTE IGUS, CAVO JAGWIRE & UNA CARTUCCIA IDRAULICA INDIPENDENTE CHE OFFRE QUALITÀ E AFFIDABILITÀ INDISCUSSE IN QUESTO SETTORE.

JOINT D'ÉTANCHÉITÉ PREMIUM TRELLEBORG, ROULEMENTS ET CLES EXCLUSIFS IGUS, TRANSMISSION JAGWIRE & ET UNE CARTOUCHE HYDRAULIQUE AUTONOME PROCURENT UNE QUALITÉ ET UNE FIABILITÉ DE POINTE.

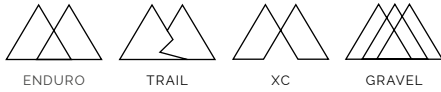

HIGHLINE 11  
100mm  
125mm  
150mm  
170mm

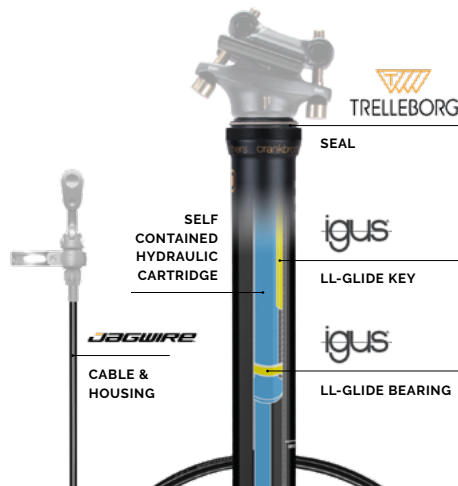

### COMPONENTI PREMIUM

- cartuccia idraulica indipendente e proprietaria IFP sull'Highline 11, sviluppato da Crankbrothers per attuazioni estremamente fluide
- cuscinetti di scorrimento e calotte proprietarie Igus LL per ridurre ogni possibile gioco
- cavi e guaine Jagwire

### COMPOSANTS PREMIUM

- cartouche hydraulique IFP autonome exclusive sur Highline 11 développée par CB pour un fonctionnement extrêmement doux
- roulements et clés exclusifs Igus LL-glide pour minimiser le jeu
- Câble et gaine Jagwire

### QUICK-SADDLE INSTALLATION SYSTEM



### CARATTERISTICHE DELLA TESTA

- testa in alluminio
- viti di montaggio in titanio
- morsetto a due viti per una facile installazione, regolazione in arretramento/avanzamento e inclinazione della sella
- 47 mm di stack minimo per un'escursione piena anche sulle bici più piccole

### CARACTERISTIQUES DE LA TÊTE

- tête en aluminium
- visserie titane
- tête à dégagement rapide à 2 boulons pour faciliter le réglage de l'avancée ou le recul et l'inclinaison de la selle
- hauteur de la pile minimale de 47 mm procurant une course complète pour les vélos de petites tailles



LINEAR PULL CABLE

### SISTEMA DI ATTUAZIONE

- il sistema di ingaggio lineare a connessione rapida garantisce un'installazione e un'instradamento facile dei cavi
- questa caratteristica consente un'azione più fluida e maggiore velocità di ritorno

### ACTUATOR SYSTEM

- le mécanisme de traction linéaire à connexion rapide facilite l'installation et l'acheminement des cables.
- cette fonction permet une action plus souple et une vitesse de retour plus rapide

### CARACTERISTIQUES

- disponibile in versione: 100mm/125mm/150mm/170mm + infiniti step intermedi di regolazione
- diametri: 30.9 & 31.6
- lunghezza porzione insertata: vedi tabella
- pesi: vedi tabella
- canotto in carbonio
- viti di montaggio in titanio
- 4 anni di garanzia

### CARATTERISTICHE

- Disponible en version: 100mm/125mm/150mm/170mm avec des réglages de course multiples
- diamètres: 30.9 & 31.6
- longueurs d'insertion: voir tableau
- poids: voir tableau
- fourreau carbone
- visserie titane
- garantie de 4 ans



DROPPER SEATPOST

## HIGHLINE 7 & 3 REGGISSELLA TELESCOPICO TIGE DE SELLE TÉLESCOPIQUE 7 & 3

GUARNIZIONI D'ALTA GAMMA TRELLEBORG, SCORRIMENTI E PARTI ESCLUSIVE IGUS, CABLAGGI JAGWIRE, CARTUCCIA IDRAULICA INDIPENDENTE E AFFIDABILE, PRODOTTA DA UN'AZIENDA LEADER.

JOINT D'ETANCHEITE PREMIUM TRELLEBORG, ROULEMENTS EXCLUSIFS IGUS, TRANSMISSION JAGWIRE, CARTOUCHE HYDRAULIQUE INDEPENDANTE, DE QUALITE ET FIABILITE PRODUITE PAR UNE FIRME A LA POINTE DE LA TECHNOLOGIE.



7

HIGHLINE 7  
100mm  
125mm  
150mm  
170mm  
200mm

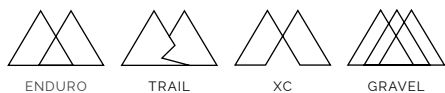

3

HIGHLINE 3  
80mm  
100mm  
125mm  
150mm  
170mm  
200mm





## DROPPER SEATPOST

# HIGHLINE XC/REGGISSELLA TELESCOPICO DA GRAVEL BIKE TIGE DE SELLE TÉLESCOPIQUE XC POUR VÉLO GRAVEL

UN REGGISSELLA TELESCOPICO CON SEZIONE RIDOTTA CHE OFFRE OPZIONI CONTENUTE DI ESCURSIONE ADATTE AL CROSS COUNTRY E AL GRAVEL BIKING.

UNE TIGE DE SELLE TÉLESCOPIQUE D'UN DIAMÈTRE RÉDUIT PARFAITEMENT ADAPTÉE POUR LA RANDONNÉE VTT ET GRAVEL.

HIGHLINE XC/GRAVEL Ø 27,2mm  
60mm  
80mm  
100mm  
125mm



HYDRAULIC IFP CARTRIDGE



QUICK-CONNECT LINEAR  
PULL ACTUATOR



60mm MINIMUM STACK HEIGHT

### CARATTERISTICHE

- disponibile in versione 60mm / 80mm / 100mm / 125mm
- + infiniti step intermedi di regolazione
- diametro: 27,2mm
- lunghezza della porzione insertata: 174mm corta & 264mm lunga / 264mm / 264mm / 264mm (dalla parte inferiore del collarino alla parte inferiore dell'attuatore)
- pesi: 369g & 410g / 434g / 459g / 467g
- il sistema di scorrimento lineare quick-connect facilita l'installazione e l'instradamento del cavo
- 60mm di stack minimo
- cartuccia idraulica IFP indipendente
- morsetto standard a due viti
- routing interno
- meccanismi interni premium
- cavo e guaina Jagwire®
- comando remoto venduto separatamente
- 4 anni di garanzia

### CARACTERISTIQUES

- disponible en version 60mm / 80mm / 100mm / 125mm avec des réglages de course multiples
- diamètre: 27,2mm
- longueurs d'insertion: 174mm au plus court et 264mm au plus long / 264mm / 264mm / 264mm (du bas du collier à la partie inférieure de l'actuateur)
- poids: 369g & 410g / 434g / 459g / 467g
- le mécanisme de traction linéaire à connexion rapide Quick-connect facilite la mise en place et le positionnement des câbles
- minimum 60mm de "stack"
- cartouche hydraulique IFP indépendante
- tête standard à deux vis
- routage interne
- mécanismes internes premium
- câble et gaine Jagwire®
- télécommande vendue séparément
- garantie de 4 ans

## DROPPER SEATPOST



HIGHLINE 11							
ARTICLE	UPC	MODEL	TRAVEL	DIAMETER	LENGTH	WEIGHT*	PRICE (€)
16481	641300164810	<b>highline 11*</b> (No remote lever included)	100mm	30.9	367mm	398g	€ 400
16482	641300164827			31.6		418g	€ 400
16483	641300164834		125mm	30.9	417mm	429g	€ 400
16484	641300164841			31.6		449g	€ 400
16485	641300164858		150mm	30.9	467mm	465g	€ 400
16486	641300164865			31.6		486g	€ 400
16487	641300164872		170mm	30.9	507mm	488g	€ 400
16488	641300164889			31.6		509g	€ 400



HIGHLINE 7							
ARTICLE	UPC	MODEL	TRAVEL	DIAMETER	LENGTH	WEIGHT*	PRICE (€)
16378	641300163783	<b>highline 7</b> (No remote lever included)	100mm	30.9	367mm	474g	300
16379	641300163790			31.6		490g	300
16380	641300163806		125mm	30.9	417mm	515g	300
16381	641300163813			31.6		525g	300
16382	641300163820		150mm	30.9	467mm	550g	300
16383	641300163837			31.6		572g	300
16384	641300163844		170mm	30.9	507mm	583g	300
16385	641300163851			31.6		604g	300
16621	641300166210	200mm	31.6	567mm	679g	300	

(\*) Il peso include solo il reggisella. La guaina aggiunge tra i 20 e i 60 grammi in base alla lunghezza.

(\*) Le poids comprend seulement la tige de selle. Le logement extérieur ajoute 25-60 g en fonction de la longueur.



## DROPPER SEATPOST

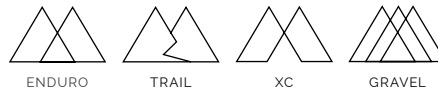

HIGHLINE 3							
ARTICLE	UPC	MODEL	TRAVEL	DIAMETER	LENGTH	WEIGHT*	PRICE (€)
16501	641300165015	<b>highline 3</b> (No remote lever included)	80mm	30.9	418mm	540g	200
16502	641300165022			31.6		564g	200
16370	641300163707		100mm	30.9	370mm	484g	200
16371	641300163714			31.6		503g	200
16469	641300164698		34.9	603g	200		
16372	641300163721		125mm	30.9	421mm	525g	200
16373	641300163738			31.6		545g	200
16471	641300164711		34.9	645g	200		
16374	641300163745		150mm	30.9	469mm	565g	200
16375	641300163752			31.6		587g	200
16472	641300164728		34.9	699g	200		
16376	641300163769		170mm	30.9	509mm	585g	200
16377	641300163776			31.6		609g	200
16473	641300164735		34.9	735g	200		
16523	641300165237		200mm	31.6	569mm	686g	200

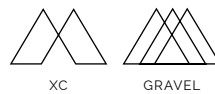

HIGHLINE XC/GRAVEL							
ARTICLE	UPC	MODEL	TRAVEL	DIAMETER	LENGTH	WEIGHT*	PRICE (€)
16489	641300164896	<b>highline xc/gravel</b> (No remote lever included)	60mm short	27.2	297mm	369g	250
16490	641300164902		60mm long	27.2	387mm	410g	250
16500	641300165008		80mm	27.2	407mm	434g	250
16468	641300164681		100mm	27.2	427mm	459g	250
16470	641300164704		125mm	27.2	452mm	467g	250

(\*) Il peso include solo il reggisella. La guaina aggiunge tra i 20 e i 60 grammi in base alla lunghezza.

(\*) Le poids comprend seulement la tige de selle. Le logement extérieur ajoute 25-60 g en fonction de la longueur.

## HIGHLINE REMOTE KIT

# IL CONTROLLO REMOTO PIÙ ERGONOMICO LA PLUS ERGONOMIQUE

IL CONTROLLO REMOTO DELL'HIGHLINE È CARATTERIZZATO DA UN SISTEMA DI REGOLAZIONE SFERICO, CON UNA CAPACITÀ DI ROTAZIONE QUASI COMPLETA E LA POSSIBILITÀ DI REGOLARE L'INCLINAZIONE PER UNA PERFETTA ERGONOMIA.

LA COMMANDE DE L'HIGHLINE SE CARACTÉRISE PAR UN SYSTÈME D'AJUSTEMENT SPHÉRIQUE UNIQUE EN SON GENRE. IDÉALE SUR LE PLAN ERGONOMIQUE, ELLE PERMET À CHAQUE PILOTE DE LA POSITIONNER SUR LE CINTRE À LA POSITION PARFAITE.



**HIGHLINE EVO**  
FLATBAR DROPPER POST REMOTE KIT  
MATCHMAKER



**HIGHLINE EVO**  
FLATBAR DROPPER POST REMOTE KIT  
22.2 CLAMP



**HIGHLINE EVO**  
FLATBAR DROPPER POST REMOTE KIT  
I-SPEC EV



**HIGHLINE**  
FLATBAR DROPPER POST REMOTE KIT  
22.2 CLAMP



**HIGHLINE**  
DROPBAR DROPPER POST REMOTE KIT V2

ARTICLE	UPC	MODEL	PRICE (€)
16754	641300167545	<b>highline EVO - flatbar dropper post remote kit 22.2 clamp</b>	70
16755	641300167552	<b>highline EVO - flatbar dropper post remote kit matchmaker</b>	70
16756	641300167569	<b>highline EVO - flatbar dropper post remote kit I-Spec EV</b>	70
16066	641300160669	<b>highline remote kit 22.2 clamp</b>	60
16824	641300168245	<b>highline dropbar remote kit V2</b>	50



# CIGAR TOOL

KIT COMPATTO DI RIPARAZIONE TUBELESS CON ADATTATORE PER LA CARTUCCIA DI CO2  
KIT COMPACT DE REPARATION POUR TUBELESS COMPRENANT L'ADAPTATEUR CO2

## PLUG KIT + CO2 HEAD

### MOUNTING BRACKET

supporto porta borraccia per fissare il kit sul telaio

support porte bidon pour fixer le kit sur le cadre du vélo

### Co2 HEAD

Il connettore Klic (solo per valvole presta) consente l'uso di cartucce di Co2

L'adaptateur de cartouche klic Co2 (presta uniquement) permet l'utilisation de la cartouche Co2

Cartuccia di Co2 venduta separatamente  
Cartouche de Co2 vendue séparément



### STORAGE CASE

Custodia in alluminio con tappo superiore filettato per l'inserimento della cartuccia di CO2

Boitier de rangement en aluminium avec bouchon supérieur fileté pour cartouche Co2

### TIRE PLUG TOOL

L'utensile si avvita nel cappuccio della custodia, funzionando da maniglia

L'outil se visse dans le capuchon du boitier servant aussi de poignée.

### CARATTERISTICHE

- utensile per sigillare lo pneumatico
- 5 pezzi
- adattatore cartuccia Co2
- custodia
- supporto di montaggio
- 5 anni di garanzia
- peso 55g

### CARACTERISTIQUES

- Outil pour obturer le pneu
- Bouchons de pneu (5)
- Adaptateur de cartouche de Co2
- Casier de rangement
- Support de montage
- Garantie 5 ans
- Poids 55g

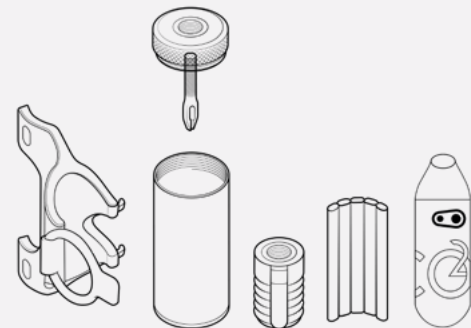

ARTICLE	UPC	MODEL	COLOR	WEIGHT	PRICE (€)
16570	641300165701	<b>tool cigar</b>	black/silver	55g	30
16637	641300166371	<b>tire plug refill kit (10 pieces)</b>	-	-	5

# TOOLS

NEW

## S.O.S TT17 TWIN TUBE KIT SOS TOOLS

- Chiavi esagonali da 2, 2.5, 3, 4, 5, 6, 8mm
  - Chiave a stella T25 Torx
  - Cacciavite piatto
  - Attrezzo per riparazione pneumatico + 2 plug
  - Cacciagomme
  - Attrezzo per catena
  - Chiavi per raggi 0, 1, 2
  - Attrezzo per valvola
  - Valvola per bombole CO2
  - Tubo per trasporto
  - Peso: 247g
  - Adatto anche per un anello di catena di ricambio + bombolette CO2 da 16/20g, vendute separatamente
- 2, 2.5, 3, 4, 5, 6, 8mm hexagonal
  - Outil torx T25
  - Tournevis plat
  - Outil pour reboucher les pneus + 2 bouchons
  - Démonte-pneu
  - Outil de chaîne
  - Clé à rayons 0, 1, 2
  - Outil de valve
  - Embout CO2
  - Tube de stockage
  - 247g
  - Contient un maillon de chaîne de rechange + 16/20g de CO2, vendus séparément



## S.O.S BC18 BOTTLE CAGE KIT SOS TOOLS

- Portaborraccia con ingresso reversibile sinistro/destro
  - Chiavi esagonali da 2, 2.5, 3, 4, 5, 6, 8mm
  - Chiavi torx T10 e T25
  - Cacciavite piatto
  - Strumento per riparazione pneumatici + 4 plug
  - Cacciagomme
  - Strumento per catena
  - Chiavi per raggi 0, 1, 2
  - Strumento per valvola
  - Valvola per cartucce CO2
  - Peso: 247g
  - Adatto per contenere un collegamento catena di scorta + cartucce CO2 da 16/20/25g o la pompa Crankbrothers Klic HV (venduti separatamente)
  - Larghezza ottimizzata per una massima libertà di pedalata
- Entrée du bidon réversible gauche/droite conception de la cage
  - Outils 2, 2.5, 3, 4, 5, 6, 8mm hex
  - Outils T10, T25 torx
  - Tournevis plat
  - Outil pour mèches de pneus + 4x mèches
  - Démonte-pneu
  - Dérive chaîne
  - Clé à rayons 0, 1, 2
  - Extracteur de valve
  - Tête CO2
  - 247g
  - Contient un maillon de chaîne de rechange + 16/20/25g CO2 ou pompe Crankbrothers Klic HV, vendue séparément
  - Largeur optimisée pour un maximum de dégagement au pédalage



## S.O.S BC2 BOTTLE CAGE + SOS TOOLS

- Design del portaborraccia con ingresso reversibile sinistro/destro
  - Attrezzo per riparazione pneumatico + 2 plug
  - Cacciagomme
  - Peso: 73g
- Entrée réversible du bidon gauche/droite conception de la cage
  - Outil pour reboucher les pneus + 2 bouchons
  - Démonte-pneu
  - 73g





# TOOLS

**NEW**

## S.O.S TS2 TUBE STASH + SOS TOOLS

- Trasporto di una camera d'aria/ materiale con una cinghia in velcro
- Attrezzo per riparazione pneumatico + 2 plug
- Cacciagomme
- Peso: 53g
- Rangement chambre à air et du matériel avec sangle auto-agrippante
- Outil pour reboucher les pneus + 2 bouchons
- Démonte-pneu
- 53g



## S.O.S TS18 TUBE STASH KIT SOS TOOLS

- Spazio per una camera d'aria/ materiale con cinghia in velcro
- Chiavi esagonali da 2, 2.5, 3, 4, 5, 6, 8mm
- Chiavi a stella T10, T25 Torx
- Cacciavite piatto
- Attrezzo per riparazione pneumatico + 4 plug
- Cacciagomme
- Attrezzo per catena
- Chiavi per raggi 0, 1, 2
- Attrezzo per valvola
- Valvola per bombole CO2
- Peso: 229g
- Adatto per un anello di catena di ricambio + bombole CO2 da 16/20/25g o pompa Crankbrothers Klic HV, vendute separatamente
- Larghezza ottimizzata per la massima libertà di pedalata
- Rangement chambre à air et du matériel avec sangle auto-agrippante
- 2, 2.5, 3, 4, 5, 6, 8mm hexagonal
- Outils torx T10, T25
- Tournevis plat
- Outil pour reboucher les pneus + 4 bouchons
- Démonte-pneu
- Outil de chaîne
- Clés à rayons 0, 1, 2
- Outil de valve
- Embout CO2
- 229g
- Contient un maillon de chaîne de rechange + 16/20/25g CO2 ou pompe Crankbrothers Klic HV, vendue séparément
- Largeur optimisée pour un dégagement de pédalage maximal



ARTICLE	UPC	NEW	MODEL	PRICE (€)
16774	641300167743	<b>NEW</b>	<b>tool S.O.S. TT17 twin tube tool kit</b>	120
16776	641300167767	<b>NEW</b>	<b>tool S.O.S. BC18 bottle cage kit</b>	100
16775	641300167750	<b>NEW</b>	<b>tool S.O.S. BC2 bottle cage +</b>	40
16777	641300167774	<b>NEW</b>	<b>tool S.O.S. TS2 tube stash +</b>	30
16778	641300167781	<b>NEW</b>	<b>tool S.O.S. TS18 tube stash tool kit</b>	90



# TOOLS

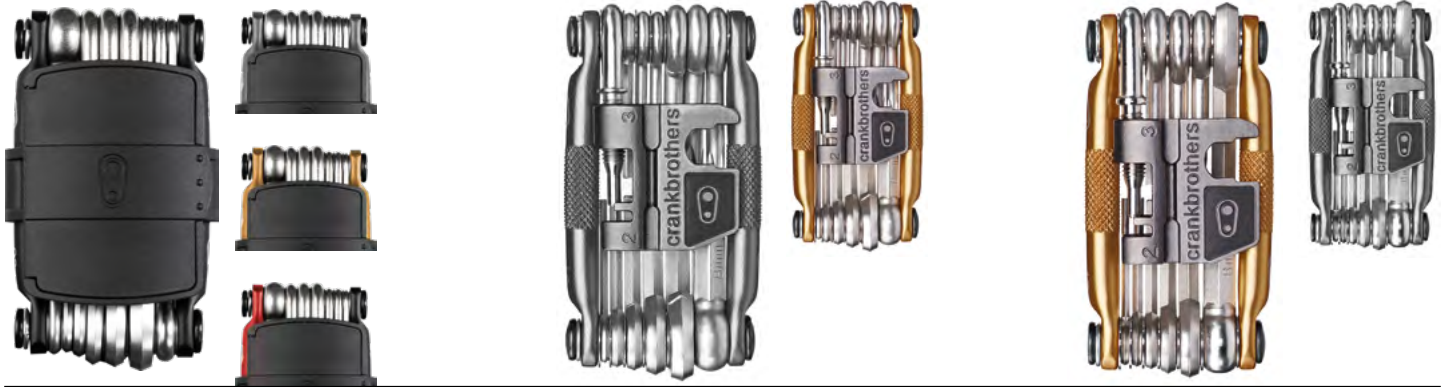

M20

M19

M17



M17 - SPLATTER EDITION

M13

M10

M5

ARTICLE	UPC	MODEL	COLOR	WEIGHT	PRICE (€)
16403	641300164032	<b>multi 20</b>	matte black	203g	40
16402	641300164025		nickel		40
16405	641300164056		gold		40
16404	641300164049		matte black/red		40
11465	641300352194	<b>multi 19</b>	nickel	175g	37
10758	641300351197		gold		37
10752	641300350176	<b>multi 17</b>	nickel	168g	30
10755	641300351173		gold		30
16679	641300166791		<b>multi 17 splatter edition</b>		red*
16681	641300166814		green*	168g	30
16682	641300166821		blue*	30	30
16399	641300163998	<b>multi 13</b>	matte black	164g	27
16398	641300163981		nickel		27
16401	641300164018		gold		27
16400	641300164001		matte black/red		27
10747	641300350107	<b>multi 10</b>	nickel	124g	20
10750	641300351104		gold		20
10743	641300350053	<b>multi 5</b>	nickel	85g	15
10745	641300351050		gold		15

(\*) Fino ad esaurimento scorte | Jusqu'à épuisement des stocks



# TOOLS



F16

F11

F15

F10+

## TOOL BITS

	HEX 2	HEX 2.5	HEX 3	HEX 4	HEX 5	HEX 6	HEX 8	PHIL #1	PHIL #2	FLAT	TORX 10	TORX 25	OPEN WRENCH 8MM	OPEN WRENCH 10MM	ROTOR ALIGNMENT	CHAIN TOOL	SPOKE WRENCH	VALVE CORE TOOL	TIRE PLUG TECH	
M5 85g			●	●	●	●			●											
M10 150g	●	●	●	●	●	●	●		●	●		●								
M13 164g	●	●	●	●	●	●	●	●	●	●	●	●						●	●	
M17 168g	●	●	●	●	●	●	●		●	●		●	●	●		●	●			
M19 175g	●	●	●	●	●	●	●	●	●	●	●	●	●	●		●	●			
M20 203g	●	●	●	●	●	●	●	●	●	●	●	●	●		●	●	●	●	●	●
F10 116g	●	●	●	●	●	●	●		●	●		●								
F11 131g	●	●	●	●	●	●	●		●	●		●								●
F15 164g	●	●	●	●	●	●	●		●	●		●				●	●			
F16 179g	●	●	●	●	●	●	●		●	●		●				●	●			●

ARTICLE	UPC	MODEL	COLOR	WEIGHT	PRICE (€)
16753	641300167538	<b>f16</b>	black	179g	60
16092	641300160928	<b>f15</b>	black/silver	169g	50
16752	641300167521	<b>f11</b>	black	131g	50
16091	641300160911	<b>f10+</b>	black/silver	121g	40



PUMPS & CO<sub>2</sub>

## THE WORKSHOP ESSENTIAL



## FLOOR PUMPS

# POMPA A TERRA KLIC | POMPES A PIEDS KLIC

- Testa magnetica
- Manichetta integrata nel corpo della pompa
- Manometro veloce da installare
- Manichetta fermata magneticamente al corpo della pompa
- Treppiede per maggiore stabilità
- 160 psi / 11 bar
- Serbatoio removibile
- Il serbatoio può essere rimosso per montare facilmente tubeless
- Il serbatoio può essere trasportato facilmente
- Testa universale presta/schrader
- Manometro intuitivo

- Tête magnétique
- Embout logé dans le corps de la pompe
- Rapidité d'installation du manomètre
- Embout fixé magnétiquement sur le corps de la pompe
- Trépied assurant une stabilité parfaite
- 160 psi / 11 bar
- Réservoir amovible
- Le réservoir peut être chargé pour monter et gonfler les pneus tubeless
- Le réservoir est amovible pour transporter facilement séparément si désiré
- Tête universelle Presta/Schrader
- Manomètre



### SERBATOIO REMOVIBILE

Installa e gonfia coperture tubeless con facilità.

### RÉSERVOIR AMOVIBLE

Montage et gonflage des pneus tubeless aisé.



### TUBO NASCOSTO

Viene riposta ordinatamente quando non utilizzata.

### TUYAU FLEXIBLE INTÉGRÉ

Rangement pratique des éléments dans le corps de la pompe, après utilisation.



### CONNESSIONE MAGNETICA VELOCE

Interfaccia facile per il beccuccio e per il serbatoio.

### CONNECTION MAGNÉTIQUE ULTRA RAPIDE

Interface tuyau flexible/réservoir facile.

BECCUCCIO UNIVERSALE PER VALVOLE PRESTA / SCHRADER (SOLO CORPI VALVOLA PRESTA TUTTI FILETTATI)

TÊTE UNIVERSELLE POUR PRESTA / SCHRADER (CORPS DE VALVE PRESTA ENTièrement FILETÉS UNIQUEMENT)



ARTICLE	UPC	MODEL	COLOR	PSI / BAR	PRICE (€)
16197	641300161970	<b>klic w/ digital gauge + canister</b>	silver	160 psi / 11 bar	250
16198	641300161987	<b>klic w/ analog gauge + canister</b>	silver	160 psi / 11 bar	220

FLOOR PUMPS

POMPA A TERRA STERLING | POMPES A PIEDS STERLING

- Interruttore alta pressione/alto volume attivabile con il piede
  - Base in alluminio per stabilità e leggerezza
  - Corpo e base in alluminio resistenti alla corrosione
  - Testa intelligente: presta & schrader ready
  - Manometro bar/psi
- 
- Activation par pied de l'interrupteur haute pression/haut volume
  - Base aluminium, légère et stable
  - Corps et base aluminium, robuste et résistant à la corrosion
  - Tête compatible Presta et Schrader
  - Manomètre bar/psi



POMPA A TERRA SAPPHIRE  
POMPES A PIEDS SAPPHIRE



POMPA A TERRA GEM  
POMPES A PIEDS GEM



ARTICLE	UPC	MODEL	COLOR	PSI / BAR	HEAD	BASE	PRICE (€)
16168	641300161680	<b>sterling</b>	silver	160 psi / 11 bar	universal presta / schrader	alloy	80
16303	641300163035	<b>sapphire</b>	black	160 psi / 11 bar	universal presta / schrader	steel	60
16218	641300162182		black				60
16205	641300162052	<b>gem</b>	red	160 psi / 11 bar	2 stage presta / schrader	steel	60
16206	641300162069		green				60



CO<sub>2</sub>

# CO<sub>2</sub> CARTRIDGE



ARTICLE	UPC	MODEL	WEIGHT	DESCRIPTION	PRICE (€)
16235	641300162359		co2 25g cartridge	20 units bulk pack	121
16232	641300162328	<b>co2 cartridge</b>	co2 25g cartridge	(2 units) w/ inflator	20
16230	64130016230		co2 16g cartridge	(2 units) w/ inflator	16

## POMPE A MANO KLIC | POMPE A MAIN KLIC

- Manichetta flessibile integrata
- Testa magnetica con collarino orientabile per evitare allo sporco di penetrare
- Manichetta magnetica per installare velocemente la testa
- Testa intelligente presta e schrader ready
- Maniglia pieghevole e bloccabile
- Manometro incorporato in alcuni modelli
- Adattatore CO2 integrato in alcuni modelli
- Adattore per il montaggio sul telaio compreso su tutti i modelli
- 5 Anni di garanzia

- Raccord de pompe flexible logé dans le corps (sur tous les modèles)
- Tête magnétique orientable évitant la pénétration de saletés
- Rapidité et facilité d'installation du raccord de pompe grâce à son extrémité magnétique
- Compatible Presta / Schrader
- Poignée de pliage et de verrouillage sur tous les modèles
- Manomètre incorporé sur certains modèles
- Adaptateur CO2 incorporé dans la poignée, sur certains modèles
- Toutes le pompes sont livrées avec support de fixation au cadre
- Garantie 5 ans



### PRESTA / SCHRADER READY

Svita e inverte la testa per passare da Presta a Schrader.

### PRESTA / SCHRADER READY

Dévisser la tête pour basculer entre Presta et Schrader.



### MANOMETRO

Preciso e facile da leggere.

### MANOMÈTRES

Jauge très précise et facile à lire.



### TESTA MAGNETICA ORIENTABILE

Testa magnetica orientabile a 360 gradi per evitare allo sporco di penetrare. Manichetta magnetica per installare la testa velocemente.

### TÊTE MAGNETIQUE ORIENTABLE

Tête magnétique orientable à 360° évitant la pénétration de saletés. Extrémité du raccord magnétique permettant un montage rapide et facile sur la tête.



### MANICHETTA FLESSIBILE/MANIGLIA BLOCCABILE /ADATTATORE CO2

La maniglia pieghevole permette di estrarre la manichetta. La testa magnetica con collarino orientabile per evitare allo sporco di penetrare. Adattatore CO2 integrato in alcuni modelli.

### RACCORD FLEXIBLE ET ADAPTATEUR CO2 INCORPORE DANS LA POIGNE

Déverrouillage de la poignée pliable pour extraire le raccord. Tête magnétique orientable évitant la pénétration de saletés. Adaptateur CO2 intégré sur certains modèles.



## HAND PUMPS

### KLIC HP

ROAD SPECIFIC HIGH PRESSURE: 120 PSI / 8.3 BAR



### KLIC HV

MTB SPECIFIC HIGH VOLUME: 110 PSI / 7.6 BAR



## POMPE A MANO GEM | POMPE A MAIN GEM

130+ PSI / 9+ BAR

- Pompa premium, con adattatore alta pressione/alto volume brevettato per un gonfiaggio facilitato.
- Testa intelligente che si adatta automaticamente alla valvola presta o schrader.
- Disponibile in due lunghezze, con o senza manometro.
- Pompes premium avec interrupteur haute pression/haut volume breveté, pour un gonflage facile.
- Embout compatible pour adaptation sur valve Presta ou Schrader.
- Disponible en deux longueurs, avec ou sans manomètre.



ARTICLE	UPC	MODEL	DESCRIPTION	COLOR	LENGTH	WEIGHT	PRICE (€)
16116	641300161161		klic hp gauge w/ co2		260mm	142g	60
16114	641300161147	<b>klic hp</b>	klic hp gauge	silver	260mm	132g	50
16112	641300161123		klic hp		260mm	102g	40
16117	641300161178		klic hv gauge w/ co2		260mm	145g	60
16115	641300161154	<b>klic hv</b>	klic hv gauge	silver	260mm	135g	50
16113	641300161130		klic hv		260mm	105g	40
14683	641300146830			red			25
14685	641300146854	<b>gem S</b>	-	green	176mm	131g	25
14681	641300146816			silver			25



**Continental**   
The Future in Motion



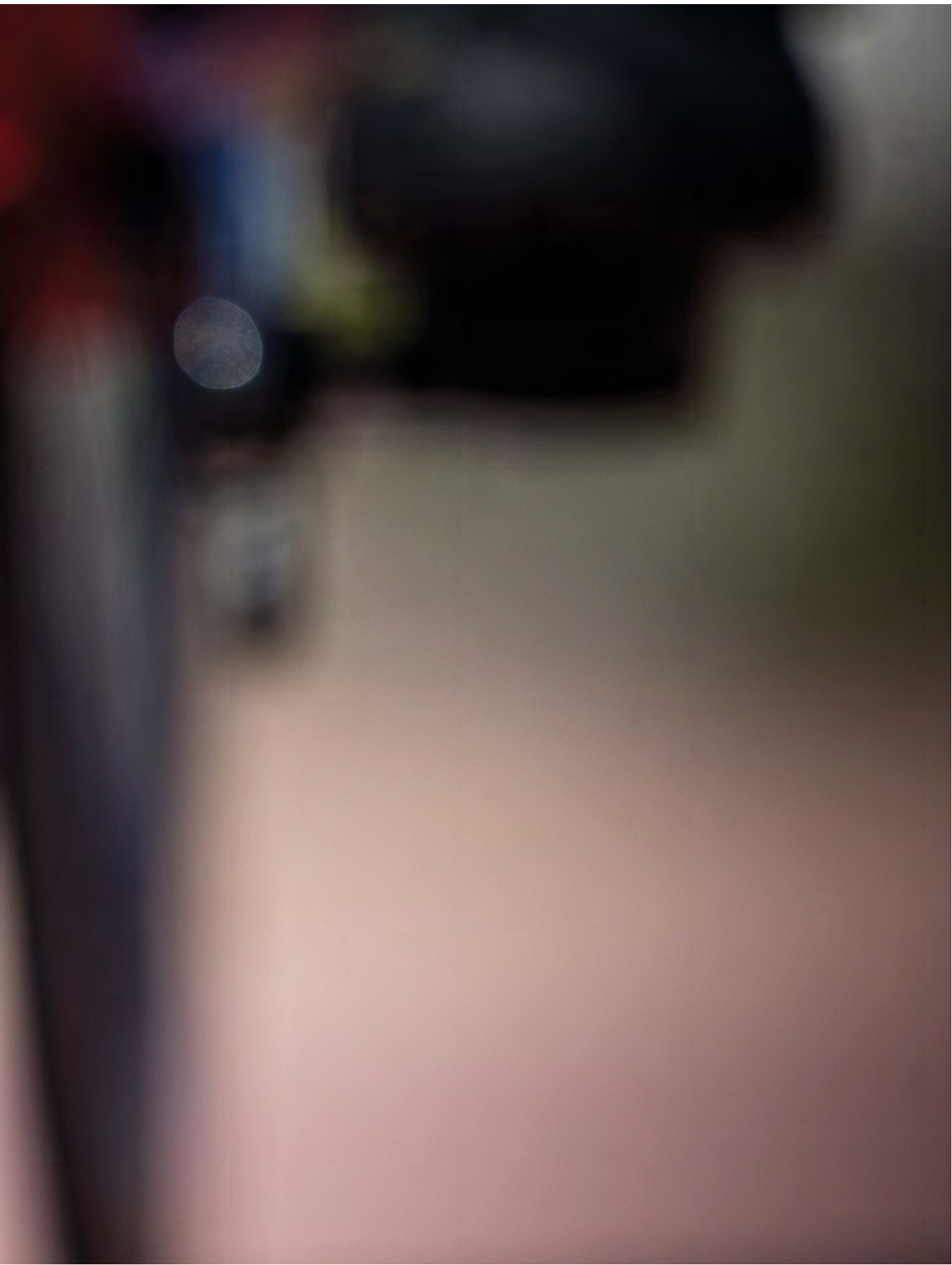

# MADE IN GERMANY



## **PASSIONE E TECNOLOGIA**

**Produrre i migliori pneumatici è il nostro imperativo. Per questo i nostri designer ed ingegneri sono sempre impegnati a rendere i nostri prodotti più efficienti, ad esempio sviluppando o migliorando formulazioni per le nostre mescole. Queste innovazioni spesso non sono evidenti a prima vista, ma sono decisamente rimarchevoli. Pedala la differenza, pedala il "Made in Germany".**

Continental, l'unico produttore di pneumatici da ciclismo in Germania. "Handmade in Germany" significa che gli pneumatici sono prodotti nel nostro stabilimento di Korbach, la maggior parte a mano e con un'alta proporzione di lavoro manuale, dal design della gomma al controllo di qualità finale. Per te questo significa offrire ai tuoi clienti pneumatici con tecnologia tedesca, così come accade dal 1871.

## **PASSION ET TECHNOLOGIE**

**Notre objectif: produire les meilleurs pneus au monde. C'est la raison pour laquelle nos designers et ingénieurs travaillent en permanence à l'amélioration de nos produits, développant par exemple régulièrement de nouveaux mélanges de gomme ou améliorant les formules existantes. Si ces changements ne sont pas toujours visibles au premier coup d'œil, vous les remarquerez à l'usage sans aucun doute! Sentez la différence, appréciez le fait main "Made in Germany".**

Continental est le seul producteur allemand de pneus pour cyclistes en Allemagne. La mention "handmade in Germany" indique que les pneus sont produits dans notre usine de Korbach, principalement à la main et avec une forte proportion de travail manuel, du design du pneu jusqu'au contrôle qualité final. Pour vous, cela signifie que vous allez offrir à vos clients des pneus de technologie allemande - une tradition depuis 1871.



## PASSIONE E PRECISIONE

Solo i materiali di altissima qualità sono usati per produrre i nostri tubolari. I singoli elementi sono combinati e uniti con precisione. I ciclisti più famosi al mondo mettono tutta la loro fiducia nel nostro lavoro. Che sia strada o pista, i tubolari prodotti da Continental hanno lasciato il loro segno nelle competizioni in giro per il mondo.

- Undici dei dodici pneumatici prodotti nel nostro stabilimento di Korbach sono fatti a mano
- La camera d'aria è cucita direttamente sulla carcassa con circa 400 punti
- Tecnologia tedesca che coinvolge tutta la struttura e la costruzione dello pneumatico
- Conformi al 100 % ai controlli di qualità

### VANTAGGI

**Leggero:** peso inferiore di uno pneumatico copertoncino.

**Veloce:** alte velocità grazie alla bassa resistenza al rotolamento.

**Adattabilità:** può essere utilizzato con alte pressioni di esercizio.

**Sicuro:** nel caso di foratura durante l'utilizzo lo pneumatico non uscirà dalla gola del cerchio: perfetto per la competizione. Chiedilo ai professionisti!

## PRÉCISION ET PASSION

Nous n'utilisons que des matières premières de qualité supérieure pour fabriquer nos boyaux. Les divers éléments sont ensuite assemblés entre eux avec le plus grand soin. Les meilleurs cyclistes nous font confiance: que ce soit sur route ou sur piste, les boyaux Continental ont laissé leur empreinte dans les compétitions à travers le monde.

- Onze des douze pneus que nous produisons dans notre usine de Korbach sont fabriqués à la main
- La chambre à air est cousue directement sur la carcasse par environ 400 points de couture
- Technologie Made in Germany
- Respect à 100 % des normes de contrôle qualité

### AVANTAGES

**Légèreté:** Poids inférieur à un pneu pliable.

**Rapide:** Vitesse élevée grâce à une faible résistance au roulement.

**Adaptabilité:** Peut supporter une pression élevée.

**Sûr:** En cas de crevaison en roulant, le pneu ne déjante pas: parfait pour la compétition. Plébiscité par les coureurs professionnels!

# ROAD





### Grand Prix 5000 [Clincher]

**È IL TUO MOMENTO!** La nuova era nel ciclismo: il miglior allrounder del settore, portato ad un livello di prestazioni completamente nuovo!

**C'EST VOTRE TEMPS!** La nouvelle ère du cyclisme - Le meilleur acteur sur le terrain, permet d'atteindre le plus haut niveau de performance!



**Lazer Grip**, per renderti un tutt'uno con la strada. La scolpitura micropuntinata si estende fin sulle spalle dello pneumatico, per ottenere un'eccezionale tenuta in curva.

**Lazer Grip**, pour ne faire qu'un avec la route. La structure sculptée en micro pointe sur la partie haute des flancs procure une adhérence parfaite en courbe.



**Tecnologia Active Comfort.** Approccio rivoluzionario nel ciclismo. Incorporata nella costruzione dello pneumatico, la tecnologia Active Comfort smorza le vibrazioni e rende più confortevole la vostra guida.

**Technologie Active Comfort.** L'approche révolutionnaire du cyclisme. Intégrée à la construction du pneu, la technologie Active Comfort absorbe les vibrations et rend votre conduite plus souple.

ARTICLE	EAN	ETRTO	DIMENSION	COLOR/SIDEWALL	TECHNOLOGY	WEIGHT	BAR	MAX.BAR	PRICE (€)
<b>Grand Prix 5000</b>									
C0101624	4019238007824	25-622	28"1700x25 C	black/black skin foldable	Vectran B./LazerGrip/ACT	215g	6,50	8,50	74,99
C0101895	4019238056235	25-622	28"1700x25 C	black/transparent fold.	Vectran B./LazerGrip/ACT	225g	6,50	8,50	74,99
C0101947	4019238 064711	25-622	28"1700x25C	black/cream foldable	Vectran B./LazerGrip/ACT	260g	6,50	8,50	74,99
C0101625	4019238007848	28-622	28"1700x28 C	black/black skin foldable	Vectran B./LazerGrip/ACT	235g	6,50	8,00	74,99
C0101896	4019238056242	28-622	28"1700x28 C	black/transparent fold.	Vectran B./LazerGrip/ACT	235g	6,50	8,50	74,99
C0101948	4019238 064728	28-622	28"1700x28C	black/cream foldable	Vectran B./LazerGrip/ACT	290g	6,50	8,00	74,99
C0101813	4019238041972	30-622	28"1700x30 C	black/black skin foldable	Vectran B./LazerGrip/ACT	260g	6,00	7,00	74,99
C0101626	4019238007855	32-622	28"1700x32 C	black/black skin foldable	Vectran B./LazerGrip/ACT	290g	6,00	7,00	74,99



### Grand Prix 5000 S Tubeless [Tubeless]

**VERSIONE TUBELESS.** Il nuovo Grand Prix 5000 S Tubeless Ready: più leggero, più veloce e con fianchi più resistenti. Il nuovo standard della tecnologia tubeless ready su strada. Più velocità, più comfort e una maggiore protezione dalle forature per le tue uscite in bici. Fatto per migliorare le tue prestazioni.

**VERSION TUBELESS.** Le nouveau Grand Prix 5000 S Tubeless Ready : Plus léger, plus rapide et avec des flancs plus résistants. La nouvelle norme en matière de technologie Tubeless Ready pour la route. Roulez plus vite, plus confortablement et avec une protection accrue contre les crevaisons. Conçu pour vous rendre meilleur.



**Lazer Grip**, per renderti un tutt'uno con la strada. La scolpitura micropuntinata si estende fin sulle spalle dello pneumatico, per ottenere un'eccezionale tenuta in curva.

**Lazer Grip**, pour ne faire qu'un avec la route. La structure sculptée en micro pointe sur la partie haute des flancs procure une adhérence parfaite en courbe.



**Tecnologia Active Comfort.** Approccio rivoluzionario nel ciclismo. Incorporata nella costruzione dello pneumatico, la tecnologia Active Comfort smorza le vibrazioni e rende più confortevole la vostra guida.

**Tecnologie Active Comfort.** L'approche révolutionnaire du cyclisme. Intégrée à la construction du pneu, la technologie Active Comfort absorbe les vibrations et rend votre conduite plus souple.



**Tallone tubeless ready.** Sviluppato specificamente, il tallone tubeless sigilla il cerchio grazie alla sua forma unica e fornisce un montaggio stabile nella gola.

**Tubeless Ready Bead.** Spécialement étudiée, la forme unique des talons du pneu permet un ajustement parfait et stable sur la gorge de la jante.

ARTICLE	EAN	ETRTO	DIMENSION	COLOR/SIDEWALL	TECHNOLOGY	WEIGHT	BAR	MAX.BAR	PRICE (€)
<b>Grand Prix 5000 S Tubeless</b>									
C0101866	4019238054439	25-622	28"   700x25C	black/black skin fold.	Vectran B./LazerGrip/ACT	245g	5,0	7,5	87,99
C0101873	4019238055559	25-622	28"   700x25C	black/transparent fold.	Vectran B./LazerGrip/ACT	295g	5,0	7,5	87,99
C0101867	4019238054422	28-622	28"   700x28C	black/black skin fold.	Vectran B./LazerGrip/ACT	270g	5,0	6,5	87,99
C0101874	4019238055580	28-622	28"   700x28C	black/transparent fold.	Vectran B./LazerGrip/ACT	315g	5,0	6,5	87,99
C0101869	4019238054408	32-622	28"   700x32C	black/black skin fold.	Vectran B./LazerGrip/ACT	320g	3,5	5,0	87,99
C0101876	4019238055641	32-622	28"   700x32C	black/transparent fold.	Vectran B./LazerGrip/ACT	375g	3,5	5,0	87,99



### Grand Prix 5000 AllSeason TR

**PER IL CHILOMETRO IN PIÙ.** Il più resistente Grand Prix 5000: dà fiducia in tutte le condizioni meteorologiche e aumenta la tua sicurezza.

**POUR L'EXTRA MILE.** Le plus puissant Grand Prix 5000 : crée la confiance par tous les temps et renforce votre protection.



**Lazer Grip**, per renderti un tutt'uno con la strada. La scolpitura micropuntinata si estende fin sulle spalle dello pneumatico, per ottenere un'eccezionale tenuta in curva.

**Lazer Grip**, pour ne faire qu'un avec la route. La structure sculptée en micro pointe sur la partie haute des flancs procure une adhérence parfaite en courbe.



**Tecnologia Active Comfort.** Approccio rivoluzionario nel ciclismo. Incorporata nella costruzione dello pneumatico, la tecnologia Active Comfort smorza le vibrazioni e rende più confortevole la vostra guida.

**Technologie Active Comfort.** L'approche révolutionnaire du cyclisme. Intégrée à la construction du pneu, la technologie Active Comfort absorbe les vibrations et rend votre conduite plus souple.



**Tallone tubeless ready.** Sviluppato specificamente, il tallone tubeless sigilla il cerchio grazie alla sua forma unica e fornisce un montaggio stabile nella gola.

**Tubeless Ready Bead.** Spécialement étudiée, la forme unique des talons du pneu permet un ajustement parfait et stable sur la gorge de la jante.

ARTICLE	EAN	ETRTO	DIMENSION	COLOR/SIDEWALL	TECHNOLOGY	WEIGHT	BAR	MAX.BAR	PRICE (€)
<b>Grand Prix 5000 AllSeason TR</b>									
C0101910	4019238056754	25-622	28" 700x25 C	black/black reflex skin fold.	Vectran B./LazerGrip	250g	5,0	7,5	104,99
C0101911	4019238056815	28-622	28" 700x28 C	black/black reflex skin fold.	Vectran B./LazerGrip	280g	5,2	6,5	104,99
C0101912	4019238056914	32-622	28" 700x32 C	black/black reflex skin fold.	Vectran B./LazerGrip	325g	3,5	5,0	104,99
C0101913	4019238056990	35-622	28" 700x35 C	black/black reflex skin fold.	Vectran B./LazerGrip	325g	2,5	4,5	104,99
C0101901	4019238056716	25-622	28" 700x25 C	black/cream reflex skin fold.	Vectran B./LazerGrip	250g	5,1	7,5	99,99
C0101902	4019238056792	28-622	28" 700x28 C	black/cream reflex skin fold.	Vectran B./LazerGrip	280g	5,3	6,5	99,99
C0101903	4019238056884	32-622	28" 700x32 C	black/cream reflex skin fold.	Vectran B./LazerGrip	315g	3,5	5,1	99,99
C0101904	4019238056952	35-622	28" 700x35 C	black/cream reflex skin fold.	Vectran B./LazerGrip	315g	2,5	4,5	99,99





**Grand Prix 4-Season**

**PRONTO PER OGNI STAGIONE.** L'elevata protezione dalle forature e la lunga durata caratterizzano il Grand Prix 4-Season. Oltre che per durezza questo pneumatico si impone per un'ottima aderenza. Che si trovi in una competizione piuttosto che in un tour, chi lo usa beneficia della grande resistenza del tessuto DuraSkin della carcassa, un compagno affidabile per il ciclista assiduo.

**ÉQUIPÉ POUR TOUTES LES SAISONS.** Le Grand Prix 4-Season étonne par sa résistance aux contraintes extrêmes et ses performances kilométriques élevées. Il offre également une excellente adhérence sur le mouillé et en conditions hivernales à basse température. Sa double protection Vectran™ et son renfort de carcasse DuraSkin® vous met à l'abri des crevaisons et coupures. Un pneu excellent pour les grandes randos comme pour la compétition et pas uniquement en hiver!

**Grand Prix**

**ALL-ROUNDER CONFORTEVOLE.** Grand Prix è un classico all-rounder con un battistrada dal design moderno. È destinato alle biciclette da passeggio e da città. Offre una combinazione perfetta tra protezione dalle forature, comfort e scorrevolezza. Caratterizzato da una durata molto elevata, rende ogni tour un piacere puro. Uno strumento polivalente, con tante qualità.

**POLYVALENCE ET CONFORT.** Le Grand Prix est un classique synonyme de qualité et de performance. Il apporte une symbiose incontestable entre protection anti-crevaison, résistance à l'usure, performance et adhérence. Le profil moderne et le témoin d'usure complètent ses atouts. Un pneu très qualitatif qui apporte beaucoup de plaisir en randonnée.



ARTICLE	EAN	ETRTO	DIMENSION	COLOR/SIDEWALL	TECHNOLOGY	WEIGHT	BAR	MAX.BAR	PRICE (€)
<b>Grand Prix 4-Season</b>									
C0100175	4019238409116	25-622	700x25 C	black DuraSkin fold.	Double Vectran Breaker	230g	6,5	8,5	74,99
C0101105	4019238674620	28-622	700x28 C	black DuraSkin fold.	Double Vectran Breaker	295g	6,5	8,0	74,99
C0101095	4019238668131	32-622	700x32 C	black DuraSkin fold.	Double Vectran Breaker	340g	6,0	7,0	74,99
<b>Grand Prix</b>									
C0100506	4019238564617	23-622	700x23 C	black foldable	PolyX Breaker	225g	7,5	8,5	49,99
C0100637	4019238581409	25-622	700x25 C	black foldable	PolyX Breaker	230g	7,5	8,5	49,99
C0101109	4019238674590	28-622	700x28 C	black foldable	PolyX Breaker	275g	6,5	8,0	49,99



### Grand Sport Race

**ALL-ROUNDER NEL SEGMENTO PERFORMANCE.** Lo pneumatico Grand Sport Race ti porta al massimo rendimento. La combinazione perfetta di elevata protezione dalle forature, alto comfort e scorrevolezza lo rendono ideale per le competizioni e i tour. Ulteriori punti a favore sono il massimo grip in curva e la lunga durata. È un all-rounder pronto per qualsiasi sfida, anche la più impegnativa.

**LE MODÈLE POLYVALENT DU SEGMENT PERFORMANCE.** Le Grand Sport Race pousse à la performance. C'est un pneu complet et équilibré avec une protection anticrevaion et suffisamment de PureGrip Compound sur la surface de roulement qui lui permettent d'avaler sans effort les nombreux kilomètres de courses et d'entraînement. Il offre une adhérence maximale en courbes et un roulement confortable: ce multi-talents est prêt à relever tous les défis, quels qu'ils soient.



### Ultra Sport III

**PNEUMATICI MODERNI PER CHI SI AVVICINA ALLE GARE IN BICICLETTA.** Gomme adatte per il ciclismo in genere e per le competizioni. Un assortimento completo per allestire al meglio la tua bici con un eccellente rapporto qualità/prezzo. Disponibili in molte sezioni e colorazioni.

**NOUVELLE GÉNÉRATION DE PNEU POUR QUI DÉCOUVRE LE VÉLO.** Pneus pour toutes pratiques route et compétitions. Assortiment complet pour améliorer votre vélo avec un rapport qualité-prix exceptionnel. Disponible dans de nombreuses tailles et couleurs.

ARTICLE	EAN	ETRTO	DIMENSION	COLOR/SIDEWALL	TECHNOLOGY	WEIGHT	BAR	MAX.BAR	PRICE (€)
<b>Grand Sport Race</b>									
C0150001	4019238586565	23-622	700x23 C	black foldable	NyTech Breaker	230g	7,5	8,5	39,99
C0150027	4019238587319	25-622	700x25 C	black foldable	NyTech Breaker	270g	6,5	8,5	39,99
C0150118	4019238621105	28-622	700x28 C	black foldable	NyTech Breaker	330g	5,5	8,0	39,99
<b>Ultra Sport III</b>									
C0150449	4019238026641	23-622	700x23 C	black skin foldable	Performance	320g	7,5	8,5	29,99
C0150457	4019238026849	25-622	700x25 C	black skin foldable	Performance	270g	6,5	8,5	29,99
C0150466	4019238026917	28-622	700x28 C	black skin foldable	Performance	420g	5,5	8,0	29,99

# TUBULAR





### Competition

**ALL-ROUNDER NELLA CORSA PROFESSIONISTICA.** Competition è un all-rounder di utilizzo professionale all'altezza del livello World Tour. È un versatile tuttofare, veloce ed agile, che emerge al termine delle maggiori competizioni al mondo grazie al carattere sempre combattivo. Spicca per la valida miscela sviluppata specificamente da Continental e per l'inserito di protezione dalle forature.

**LE MODÈLE POLYVALENT DU MONDE DES PROS.** Le Competition est un multi-talents qui répond à toute les exigences des ProTour et autres compétitions. Ce boyau s'adapte à toutes les conditions de route et apporte agilité et vitesse. Il fait preuve d'un caractère des plus combattifs. Le mélange de gomme performant développé par Continental combiné à une protection anti-crevaisson ultra efficace lui fait prendre le rôle d'un avant-gardiste.

### Giro

**COMPAGNO DI ALLENAMENTO PER PRINCIPIANTI.** Il tubolare Giro spicca per la durata elevata e per l'eccellente rapporto prezzo/prestazione/durata. Ottime le sue proprietà di rotolamento e per la robustezza garantita anche dopo molti chilometri di allenamento. Questo pneumatico è il compagno perfetto nell'allenamento e nei tour di chi vuole avvicinarsi in modo serio al ciclismo.

**LE PARTENAIRE D'ENTRAÎNEMENT POUR LES DÉBUTANTS.** Le Giro fait sensation grâce à sa grande capacité de kilométrage et son excellent rapport qualité-prix. Il se distingue par ses excellentes propriétés de roulage et sa robustesse et il est toujours prêt même après de nombreux kilomètres d'entraînement. Ce boyau est le compagnon idéal pour les débutants, pour l'entraînement et en randonnées.



ARTICLE	EAN	ETRTO	DIMENSION	COLOR/SIDEWALL	TECHNOLOGY	WEIGHT	BAR	MAX.BAR	PRICE (€)
<b>Competition</b>									
C0196189	4019238549126	-	28"x25 mm	black	Vectran Breaker	280g	8,0	12,0	130,99
<b>Giro</b>									
C0196017	4019238107715	-	28"x22 mm	black/transparent	Performance	390g	8,0	10,0	39,99



### Sprinter

**A CACCIA DI VITTORIE.** Lo Sprinter è caratterizzato da eccezionali proprietà di rotolamento grazie alla carcassa morbida. Offre il massimo nelle gare a circuito o nel triathlon. È la risposta giusta per chi chiede massima accelerazione e a questo aggiunge un peso ridotto e una manovrabilità equilibrata, grazie al suo profilo perfettamente slick.

**LA CHASSE AUX POINTS.** Le Sprinter se distingue par ses excellentes propriétés de roulement grâce à sa carcasse souple. Il joue ses atouts surtout dans le domaine des critériums. On peut se fier à ce boyau quand il est question d'accélération maximale. Ce boyau de compétition se distingue par son faible poids et sa conduite équilibrée.

### Sprinter Gatorskin

**UN CLASSICO PER LE GRANDI CLASSICHE.** A suo agio sulle strade del Giro delle Fiandre, della Parigi-Roubaix o della Milano-Sanremo. È uno pneumatico che si caratterizza per durata, per resistenza anche su fondi dissestati e per l'elevata protezione dalle forature. Incamera grandi quantità d'aria, ad ulteriore garanzia di sicurezza, scorrevolezza e comfort, anche negli attraversamenti veloci sul pavé.

**LE CHASSEUR CLASSIQUE PASSIONNÉ.** Le Sprinter Gatorskin est chez lui sur les routes de Flandre, de Roubaix ou de San Remo. Ce boyau développé spécialement pour les courses classiques sait convaincre par sa grande résistance aux crevaisons et sa longévité kilométrique. Son volume important assure une sécurité supplémentaire et un roulement encore meilleur. Tout cela offre un grand confort sur la route même à pleine vitesse sur les pavés.



Safety System



Safety System



ARTICLE	EAN	ETRTO	DIMENSION	COLOR/SIDEWALL	TECHNOLOGY	WEIGHT	BAR	MAX.BAR	PRICE (€)
<b>Sprinter</b>									
C0196244	4019238674576	-	28"x25 mm	black	SafetySystem Breaker	295g	8,0	12,0	66,99
<b>Sprinter Gatorskin</b>									
C0196187	4019238549089	-	28"x25 mm	black	SafetySystem Breaker	300g	8,0	12,0	84,99



### Vectran™ Breaker

Vectran™ viene prodotto dal polimero a cristalli liquidi Vectra. Si ottiene un filato termoplastico a fibre multiple. Questo tessuto in parte cristallino è più resistente al taglio rispetto all'aramide, è dotato di una resistenza alla trazione cinque volte superiore dell'acciaio ed è allo stesso tempo più leggero di un corrispondente filo di nylon. Vectran™ mantiene queste caratteristiche anche alle condizioni climatiche più ostili.

La référence en matière de protection anti-crevaisson. Vectran™ est un fil high-tech synthétique dont le modèle est pris dans la nature. Comme la soie d'araignée, Vectran™ est un polymère de cristaux liquide [LPC]. Vectran™ est tissé à partir du polymère à cristaux liquides Vectra et retravaillé en un réseau multifibres. La soie d'araignée et le composé Vectran™ possèdent une énorme résistance aux déchirures pour un poids très limité. Exactement les caractéristiques qui conviennent pour être utilisées en dispositif anti-crevaisson dans un pneu Continental. Vectran™ Breaker est plus léger, plus flexible et protège encore mieux des coupures qu'une protection anti-crevaisson en Nylon. La résistance au roulement n'est pas affectée par Vectran™ Breaker.

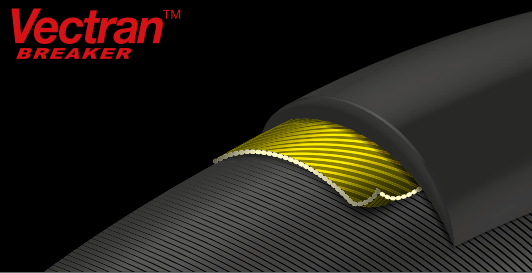

### PolyX Breaker™

Resistente alla foratura. Con il PolyX Breaker® applichiamo il know-how acquisito in ambito automobilistico nel segmento motociclistico agli pneumatici per biciclette: sugli pneumatici per autovettura il poliestere viene utilizzato da anni, con grande successo ed esiti molto positivi. Estremamente resistente, la fibra di poliestere viene tessuta a maglie strette incrociate; in questo modo si raggiunge un'elevata densità del tessuto che rende il PolyX Breaker® non solo resistente alla perforazione da parte di corpi estranei ma anche particolarmente protettivo verso le forature.

Résistant aux perforations et aux coupures. Avec PolyX Breaker®, le savoir faire automobile est appliqué au domaine du vélo: le polyester est, depuis des années utilisé avec succès dans les pneus voitures et à fait ses preuves à de nombreuses reprises. Les fibres de polyester extrêmement résistantes sont étroitement et finement tissées en croix. De la sorte, on obtient un réseau très dense, qui rend le PolyX Breaker® non seulement résistant aux corps étrangers, mais également solide face aux perforations. Là aussi, la résistance au roulement n'est pas non plus affectée par PolyX Breaker®.

PolyX Breaker™

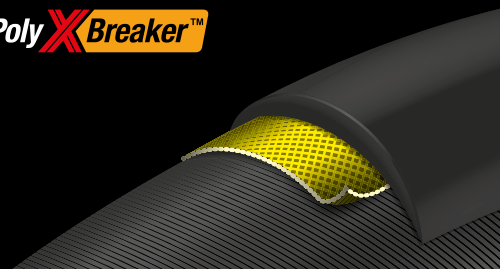

### DuraSkin®

DuraSkin®. Gli pneumatici dotati di protezione delle pareti DuraSkin® devono poter affrontare qualsiasi situazione. Vengono utilizzati in condizioni estreme. Sulle biciclette dei messenger gli pneumatici strisciano sui bordi dei marciapiedi, sulle biciclette da viaggio attraversano continenti senza usurarsi, mentre nelle gare ciclistiche devono superare le prove più ardue, come ad esempio quelle della Parigi-Roubaix. Il tessuto di poliammide di alta qualità protegge efficacemente il fianco dello pneumatico e lo rende idoneo a qualsiasi situazione estrema. Questi pneumatici sono contraddistinti da tutti gli altri dal fianco di colore marrone.

Prêt pour rouler dans les pires conditions. Les pneus équipés de la protection DuraSkin® sur les flancs sont prêts pour avoir la vie dure. Ils peuvent être utilisés dans les conditions les plus extrêmes. Les pneus des vélos de coursiers frottent sur les bords de trottoirs, durant les randonnées ils sillonnent les continents sans s'user, pendant des courses ils doivent être d'une solidité à toute épreuve, comme lors du Paris-Roubaix. Le tissage en polyamide de très haute qualité protège efficacement les flancs du pneu et prémunissent le pneu contre tous les aléas. Ces pneus se distinguent du tout-venant par leurs flancs marron.

DuraSkin®

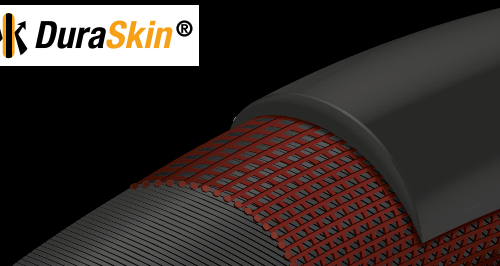

### NyTech Breaker

Una tecnologia antiforatura strutturata con fibre di nylon protettive. È simile al Kevlar ma con una bassa resistenza al rotolamento e con un peso ridotto.

Une technologie de protection anti crevaissons faite de fibres de nylon - protégeant comme le Kevlar, mais avec une faible résistance au roulement, sans en augmenter le poids.

NyTech BREAKER

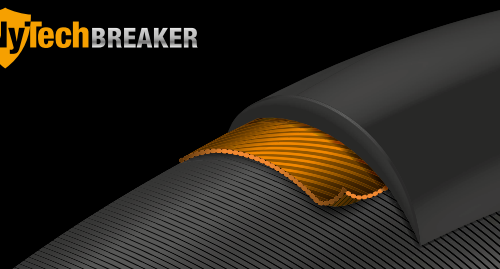

### Safety System

Resistente alle forature e ai tagli, ma allo stesso tempo leggero e flessibile, lo pneumatico si adatta meglio al fondo stradale. Assicura caratteristiche di guida molto votate al comfort.

Résistant aux perforations et aux coupures tout en restant léger et souple, le pneu s'adapte mieux au terrain pour une tenue de route des plus agréables.

Safety  System

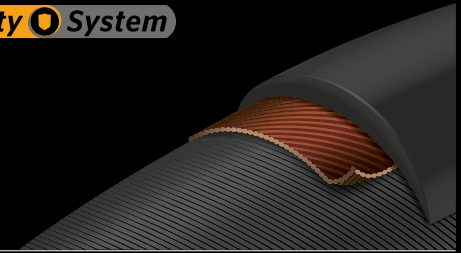

### BlackChili Compound

La miscela per copertura unica nel suo genere, prodotta solo in Germania, che rivoluzionerà gli pneumatici per biciclette! Con la BlackChili Compound il compromesso tra maggior grip e bassa resistenza al rotolamento è stato portato ai massimi livelli in assoluto. I tanti primati ottenuti nei test certificano vantaggi misurabili e registrabili sia in laboratorio che sulla strada. I polimeri di nuova generazione, il particolato carbonioso frutto di nanotecnologie e gli agenti di carica garantiscono una performance davvero unica. Rappresenta il non plus ultra nei relativi ambiti di utilizzo: dalle coperture delle MTB da downhill agli pneumatici per bici da cronometro. BlackChili Compound migliora la resistenza al rotolamento del 26 per cento e offre allo stesso tempo un grip superiore di circa il 30 per cento rispetto alle mescole di silice attivato. Inoltre, gli pneumatici realizzati con il BlackChili Compound offrono una resa chilometrica superiore e, diversamente da mescole multiple, una performance costante dal primo all'ultimo chilometro.

A korbach, en Allemagne, où se trouve le siège de notre département recherche et développement pour les pneus de vélos Continental, cela fait longtemps que nos ingénieurs se creusent la tête sur un problème fondamental concernant la structure d'un pneu. En effet, les qualités de roulement du mélange de caoutchouc d'un pneu sont définies, de façon déterminante, par l'interaction de trois facteurs: le frottement statique [adhérence], la résistance au roulement et la longévité. Le dilemme est le suivant: si on améliore l'un de ces facteurs, au moins un autre de ces facteurs va par contre se dégrader. Un pneu ayant une adhérence maximale s'use plus rapidement et roule moins vite. Inversement, si on confectionne un pneu qui est plus rapide ou qui dure plus longtemps, alors son adhérence diminue. Avec la technologie de pointe d'aujourd'hui, à savoir la gomme à silice activée, on avait déjà atteint un bon compromis. Mais nos concepteurs voulaient obtenir plus. En suivant des chemins tout nouveaux, ils ont réussi en 2008 à mettre au point un mélange de gomme révolutionnaire: c'était le premier pas vers ce que l'on connaît sous le nom de Black Chili. Ce mélange de gomme totalement nouveau est basé sur les connaissances les plus récentes fournies par la recherche sur les polymères et les matières premières.



### PureGrip Compound

La miscela PureGrip è derivata da una miscela di Silice attivata ed è un buon esempio di come noi integriamo continuamente i feedback dei clienti verso il settore della ricerca e sviluppo. Questa miscela tecnologica è perfettamente declinata della miscela BlackChili Compound. Il nome PureGrip fa esattamente ciò che dice: un grip e una durezza incredibilmente superiori sono le caratteristiche distintive di questo compound. Utilizziamo la PureGrip sui nostri articoli della linea Performance e sulla gamma mountain bike.

Fabriquée à partir d'un composé de silice activée, le mélange de gomme PureGrip est la parfaite illustration de la façon dont nous prenons en compte les retours de nos clients dans nos efforts de recherche et développement. Cette technologie est une alternative au mélange de gomme BlackChili. Son nom, "PureGrip", est on ne peut plus explicite: ce composant garantit une parfaite adhérence et une durabilité exceptionnelle. Nous utilisons PureGrip dans les produits de notre gamme Performance pour les vélos de route et VTT.



### Tire Positioning System

La competenzaa dallo sport motociclistico, adattata specificamente alla bicicletta da competizione per assecondare i requisiti specifici della ruota anteriore e della posteriore. L'anteriore: agile e reattiva. Lo pneumatico più stretto assicura una riduzione della resistenza all'aria e migliora le caratteristiche di sterzata. La posteriore: confortevole e ammortizzante. Con la sua superficie di contatto al suolo leggermente più ampia lo pneumatico assicura una migliore trazione. La scorrevolezza viene migliorata grazie alla composizione ottimizzata della miscela, finalizzata alla resistenza al rotolamento. Il risultato è un sistema ruota anteriore e posteriore all'avanguardia, dove gli pneumatici sono stati attentamente accoppiati l'uno con l'altro.

Avec TirePositioning® System, on atteint les dernières limites de ce qui est techniquement possible aujourd'hui. Les motards le savent depuis longtemps: les qualités attendues du pneu avant son différentes de celles demandées au pneu arrière. Le pneu avant plus étroit diminue la résistance au vent et procure une plus grande maniabilité dans les virages. Un mélange pour bande de roulement à adhérence optimisée procure une meilleure adhérence, en particulier dans les virages sur route mouillée. Le pneu arrière plus large possède, grâce à une surface de contact plus grande, une meilleure traction et offre en même temps plus de confort. Grâce à un mélange qui diminue la résistance au roulement et à une surface de contact plus grande à l'arrière, l'abrasion se voit diminuée. Le résultat est notre système novateur pneu avant/pneu arrière pour la compétition: que l'on retrouve sur le kit GP Attack/Force. Nouveau: la technologie TPS également proposée en boyaux avec le Set Attack/Force Comp.





**GRAVEL**





### Terra Speed

**SCEGLI UNA STRADA DIVERSA, SCEGLI TERRA.** Per la tua traccia fuori strada. Per più comfort. Per l'avventura. Che sia un giro lungo, o la scorciatoia per la strada di casa. La nuova serie gravel Terra di Continental ti porta proprio dove vuoi arrivare. Terra Speed è il modello più veloce della nostra gamma. Fatto per accompagnarti tra l'asfalto e la sabbia. Fatto per accompagnarti tra percorsi sconnessi o veloci. Scegli una strada diversa, scegli Terra.

**CHOISISSEZ UNE AUTRE ROUTE, CHOISISSEZ TERRA.** Pour vos parcours en dehors de la route. Pour plus de confort. Pour l'aventure. Que ce soit un long trajet, ou le raccourci vers la maison. Le nouveau pneu Gravel Terra de Continental vous emmène là où vous souhaitez aller. Terra Speed est le modèle le plus rapide de notre gamme. Fait pour vous accompagner entre l'asphalte et le sable. Fait pour vous accompagner sur les itinéraires accidentés ou rapides. Choisissez un autre chemin, choisissez Terra.

### Terra Trail

**SCEGLI UNA STRADA DIVERSA, SCEGLI TERRA.** Per la tua traccia fuori strada. Per più comfort. Per l'avventura. Che sia un giro lungo, o la scorciatoia per la strada di casa. La nuova serie gravel Terra di Continental ti porta proprio dove vuoi arrivare. Il modello Terra Trail è il più nobile della nostra gamma. Fatto per accompagnarti tra percorsi sconnessi o veloci. Scegli una strada diversa, scegli Terra.

**CHOISISSEZ UNE AUTRE ROUTE, CHOISISSEZ TERRA.** Pour vos parcours en dehors de la route. Pour plus de confort. Pour l'aventure. Que ce soit un long trajet, ou le raccourci vers la maison. Le nouveau pneu Gravel Terra de Continental vous emmène là où vous souhaitez aller. Le modèle Terra Trail est le plus noble de notre gamme. Fait pour vous accompagner sur les itinéraires accidentés ou rapides. Choisissez un autre chemin, choisissez Terra.



ARTICLE	EAN	ETRTO	DIMENSION	COLOR/SIDEWALL	TECHNOLOGY	WEIGHT	BAR	MAX.BAR	PRICE (€)
<b>Terra Speed</b>									
C0101720	4019238029772	35-584	650x35 B   27.5x1.35	black/cream skin fold.	ProTaction	350g	3,0	5,0	69,99
C0101718	4019238029611	40-584	650x40 B   27.5x1.50	black/cream skin fold.	ProTaction	420g	3,0	5,0	69,99
C0101700	4019238026955	35-622	700x35 C   28x1.35	black/cream skin fold.	ProTaction	360g	3,0	5,0	69,99
C0101702	4019238027020	40-622	700x40 C   28x1.50	black/cream skin fold.	ProTaction	440g	3,0	5,0	69,99
C0101837	4019238052053	40-622	700x40 C   28x1.50	black/transp. skin fold.	ProTaction	440g	3,0	5,0	69,99
C0102007	4019238083439	45-622	700x45 C   28x1.70	black/transp. skin fold.	ProTaction	490g	3,0	5,0	69,99
C0101719	4019238029796	35-584	650x35 B   27.5x1.35	black/black foldable	ProTaction	390g	3,0	5,0	69,99
C0101693	4019238027013	35-622	700x35 C   28x1.35	black/black foldable	ProTaction	410g	3,0	5,0	69,99
C0101717	4019238029635	40-584	650x40 B   27.5x1.50	black/black foldable	ProTaction	420g	3,0	5,0	69,99
C0101694	4019238027099	40-622	700x40 C   28x1.50	black/black foldable	ProTaction	440g	3,0	5,0	69,99
<b>Terra Trail</b>									
C0101716	4019238029659	40-584	650x40 B   27.5x1.50	black/cream skin fold.	ProTaction	440g	3,0	5,0	69,99
C0101701	4019238027044	40-622	700x40 C   28x1.50	black/cream skin fold.	ProTaction	440g	3,0	5,0	69,99
C0101836	4019238052060	40-622	700x40 C   28x1.50	black/transp. skin fold.	ProTaction	440g	3,0	5,0	69,99
C0101715	4019238029673	40-584	650x40 B   27.5x1.50	black/black skin fold.	ProTaction	440g	3,0	5,0	69,99
C0101697	4019238027075	40-622	700x40 C   28x1.50	black/black skin fold.	ProTaction	460g	3,0	5,0	69,99
C0150509	4019238038507	47-584	650x47 B   27.5x1.75	black/black skin fold.	ShieldWall Syst.	520g	2,5	4,5	39,99
C0150508	4019238038538	47-584	650x47 B   27.5x1.75	black/cream skin fold.	ShieldWall Syst.	510g	2,5	4,5	39,99
C0150503	4019238038460	35-622	700x35 C   28x1.35	black/black skin fold.	ShieldWall Syst.	425g	3,0	5,0	39,99
C0150505	4019238038491	35-622	700x35 C   28x1.35	black/cream skin fold.	ShieldWall Syst.	445g	3,0	5,0	39,99
C0150507	4019238038545	40-622	700x40 C   28x1.50	black/black skin fold.	ShieldWall Syst.	495g	3,0	5,0	39,99
C0150673	4019238064506	40-622	700x40 C   28x1.50	black/brown skin fold.	ShieldWall Syst.	440g	3,0	5,0	39,99
C0150675	4019238064476	45-622	700x45 C   28x1.70	black/black skin fold.	ShieldWall Syst.	500g	2,5	4,5	39,99

# MOUNTAIN BIKE





Umido  
Terrain Mixte



KRYPTOTAL Fr

KRYPTOTAL Re



### Kryptotal Fr

**LA SCELTA PER TERRENI E CONDIZIONI MISTI.** Progettato per abbinarsi perfettamente al Kryptotal Re e ottimizzato per manovrabilità e agilità della ruota anteriore. Ideale per terreni misti e per l'impiego Trail, Enduro o DH Gravity.

**CONÇU POUR LES TERRAINS ET CONDITIONS MIXTES.** Conçu pour fonctionner avec le Kryptotal Re et optimiser la maniabilité et l'agilité de la roue avant. Idéal sur les terrains mixtes en trail, enduro et descente.

### Kryptotal Re

**LA SCELTA PER TERRENI E CONDIZIONI MISTI.** Ottimizzato per la ruota posteriore, questo pneumatico offre massima versatilità ed equilibrio tra aderenza, trazione in frenata e resistenza al rotolamento. Nato per eccellere sui terreni misti, è la scelta ideale per raidare al limite nella tua disciplina preferita: Trail, Enduro o DH Gravity.

**CONÇU POUR LES TERRAINS ET CONDITIONS MIXTES.** Conçu pour la roue arrière, ce pneu polyvalent est le parfait équilibre entre stabilité, motricité et résistance au roulement. Idéal pour repousser vos limites en trail, enduro ou en descente.



ARTICLE	EAN	ETRTO	DIMENSION	COLOR/SIDEWALL	TECHNOLOGY	WEIGHT	BAR	MAX.BARPRICE (€)
<b>Kryptotal-F 2.4</b>								
C0101957	4019238070491	60-622	29" 29x2.40	black/black fold. skin	Downhill/Super Soft Comp.	1290g	2,5 3,5	99,00
C0150694	4019238074116	60-584	27.5" 27.5x2.40	black/black fold. skin	Enduro/Soft Comp.	1080g	2,5 3,5	85,00
C0150696	4019238074079	60-622	29" 29x2.40	black/black fold. skin	Enduro/Soft Comp.	1125g	2,5 3,5	85,00
C0150695	4019238074093	60-584	27.5" 27.5x2.40	black/black fold. skin	Trail/Endurance Comp.	1000g	2,5 3,5	73,00
C0150697	4019238074055	60-622	29" 29x2.40	black/black fold. skin	Trail/Endurance Comp.	1040g	2,5 3,5	73,00
<b>Kryptotal-R 2.4</b>								
C0101991	4019238080780	60-584	27.5" 27.5x2.40	black/black fold. skin	Downhill/Soft Comp.	1220g	2,5 3,5	95,00
C0101992	4019238080773	60-622	29" 29x2.40	black/black fold. skin	Downhill/Soft Comp.	1290g	2,5 3,5	95,00
C0101993	4019238080766	60-584	27.5" 27.5x2.40	black/black fold. skin	Enduro/Soft Comp.	1080g	2,5 3,5	85,00
C0150634	4019238063127	60-622	29" 29x2.40	black/black fold. skin	Enduro/Soft Comp.	1125g	2,5 3,5	85,00
C0150637	4019238063059	60-584	27.5" 27.5x2.40	black/black fold. skin	Trail/Endurance Comp.	1000g	2,5 3,5	73,00
C0150638	4019238063042	60-622	29" 29x2.40	black/black fold. skin	Trail/Endurance Comp.	1040g	2,5 3,5	73,00
<b>Kryptotal-R 2.6</b>								
C0150635	4019238063097	65-584	27.5" 27.5x2.60	black/black fold. skin	Enduro/Soft Comp.	1220g	2,0 3,0	89,00
C0150636	4019238063080	65-622	29" 29x2.60	black/black fold. skin	Enduro/Soft Comp.	1275g	2,0 3,0	89,00
C0150639	4019238063011	65-584	27.5" 27.5x2.60	black/black fold. skin	Trail/Endurance Comp.	1100g	2,0 3,0	81,00
C0150640	4019238063004	65-622	29" 29x2.60	black/black fold. skin	Trail/Endurance Comp.	1200g	2,0 3,0	81,00



Bagnato  
Terrain Meuble



### Argotal

**LA SCELTA PER TERRENI MORBIDI.** Ideale per terreni smossi, questo pneumatico offre massima stabilità in curva e maggiore aderenza laterale. Il disegno aperto del battistrada aumenta la capacità autopulente, l'ideale per spingere al massimo tra sterrati e polvere.

**CONÇU POUR LES TERRAINS MEUBLES.** Pneu idéal pour les terrains meubles, avec une adhérence latérale accrue pour une bonne stabilité dans les virages. La bande de roulement ouverte permet un auto-nettoyage afin que vous puissiez repousser vos limites de conduite sur terrains la poussiéreux et meubles.

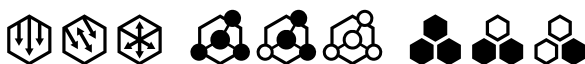

ARTICLE	EAN	ETRTO	DIMENSION	COLOR/SIDEWALL	TECHNOLOGY	WEIGHT	BAR	MAX.BAR	PRICE (€)
<b>Argotal 2.4</b>									
C0150684	4019238068016	60-584	27.5"   27.5x2.40	black/black fold. skin	Enduro/Soft Comp.	1080g	2,5	3,5	85,00
C0150686	4019238068078	60-622	29"   29x2.40	black/black fold. skin	Enduro/Soft Comp.	1160g	2,5	3,5	85,00
C0150689	4019238067972	60-584	27.5"   27.5x2.40	black/black fold. skin	Trail/Endurance Comp.	1000g	2,5	3,5	73,00
C0150691	4019238068030	60-622	29"   29x2.40	black/black fold. skin	Trail/Endurance Comp.	1040g	2,5	3,5	73,00
<b>Argotal 2.6</b>									
C0150685	4019238067910	65-584	27.5"   27.5x2.60	black/black fold. skin	Enduro/Soft Comp.	1220g	2,0	3,0	89,00
C0150688	4019238067958	65-622	29"   29x2.60	black/black fold. skin	Enduro/Soft Comp.	1275g	2,0	3,0	89,00
C0150690	4019238067897	65-584	27.5"   27.5x2.60	black/black fold. skin	Trail/Endurance Comp.	1100g	2,0	3,0	81,00
C0150692	4019238067934	65-622	29"   29x2.60	black/black fold. skin	Trail/Endurance Comp.	1200g	2,0	3,0	81,00



Asciutto  
Terrain Dur



### Xynotal

**LA SCELTA PER TERRENI COMPATTI E CONDIZIONI DI ASCIUTTO.** Perfetto per superfici dure e rocciose. Bassa resistenza al rotolamento e bordi di contatto studiati per migliorare la trazione e la frenata. Ideale per le uscite gravity veloci, quando serve maggiore grip e maggiore sicurezza.

**CONÇU POUR LES TERRAINS DURS ET LES CONDITIONS SÈCHES.** Parfait pour les surfaces dures et rocailleuses. Profiter d'un roulage rapide et d'un freinage puissant en toute confiance grâce à une adhérence continue lorsque vous en avez le plus besoin.



ARTICLE	EAN	ETRTO	DIMENSION	COLOR/SIDEWALL	TECHNOLOGY	WEIGHT	BAR	MAX.BAR	PRICE (€)
<b>Xynotal 2.4</b>									
C0150646	4019238063257	60-584	27.5"   27.5x2.40	black/black fold. skin	Trail/Endurance Comp.	1000g	2,5	3,5	73,00
C0150647	4019238063240	60-622	29"   29x2.40	black/black fold. skin	Trail/Endurance Comp.	1040g	2,5	3,5	73,00

4 NAMES, 5 PATTERNS, 1

# The all new G

CAS

TERRAIN

	TRAIL				ENDURO	
<b>HARD PACK</b>	27.5" X 2.4 <b>XY</b> XYNOTAL	29" X 2.4 <b>XY</b> XYNOTAL			27.5" X 2.4 <b>XY</b> XYNOTAL	29" X 2.4 <b>XY</b> XYNOTAL
	27.5" X 2.4 <b>Fr</b> <b>KR</b> KRYPTOTAL	29" X 2.4 <b>Fr</b> <b>KR</b> KRYPTOTAL			27.5" X 2.4 <b>Fr</b> <b>KR</b> KRYPTOTAL	29" X 2.4 <b>Fr</b> <b>KR</b> KRYPTOTAL
<b>MIXED</b>	27.5" X 2.4 <b>Re</b> <b>KR</b> KRYPTOTAL	27.5" X 2.6 <b>Re</b> <b>KR</b> KRYPTOTAL	29" X 2.4 <b>Re</b> <b>KR</b> KRYPTOTAL	29" X 2.6 <b>Re</b> <b>KR</b> KRYPTOTAL	27.5" X 2.4 <b>Re</b> <b>KR</b> KRYPTOTAL	27.5" X 2.6 <b>Re</b> <b>KR</b> KRYPTOTAL
<b>LOOSE</b>	27.5" X 2.4 <b>AR</b> ARGOTAL	27.5" X 2.6 <b>AR</b> ARGOTAL	29" X 2.4 <b>AR</b> ARGOTAL	29" X 2.6 <b>AR</b> ARGOTAL	27.5" X 2.4 <b>AR</b> ARGOTAL	27.5" X 2.6 <b>AR</b> ARGOTAL
<b>MUD</b>						

TERRAIN



HARDPACK MIXED LOOSE MUD

COMPOUND



SUPER SOFT SOFT ENDURANCE

INFINITE POSSIBILITIES

# Gravity Range

ING

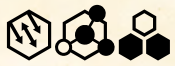

**DOWNHILL  
SOFT**

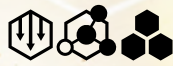

**DOWNHILL  
SUPER SOFT**

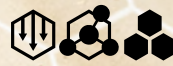

27.5" X 2.4

29" X 2.4

27.5" X 2.4

29" X 2.4

**XY**  
XYNOTAL

**XY**  
XYNOTAL

**XY**  
XYNOTAL

**XY**  
XYNOTAL

27.5" X 2.4

Fr

29" X 2.4

Fr

**KR**  
KRYPTOTAL

**KR**  
KRYPTOTAL

29" X 2.4

Re

29" X 2.6

Re

**KR**  
KRYPTOTAL

**KR**  
KRYPTOTAL

27.5" X 2.4

Re

29" X 2.4

Re

**KR**  
KRYPTOTAL

**KR**  
KRYPTOTAL

27.5" X 2.4

Re

29" X 2.4

Re

**KR**  
KRYPTOTAL

**KR**  
KRYPTOTAL

29" X 2.4

29" X 2.6

27.5" X 2.4

29" X 2.4

27.5" X 2.4

29" X 2.4

**AR**  
ARGOTAL

**AR**  
ARGOTAL

**AR**  
ARGOTAL

**AR**  
ARGOTAL

**AR**  
ARGOTAL

**AR**  
ARGOTAL

27.5" X 2.4

29" X 2.4

**HY**  
HYDROTAL

**HY**  
HYDROTAL

## RIDING



DOWNHILL



ENDURO



TRAIL

## CASING



DOWNHILL



ENDURO



TRAIL





### Cross King

**UN ALL-ROUNDER PRIMO DELLA CLASSE, COLLAUDATO ANCHE NELLE COMPETIZIONI.**

- pneumatico versatile per la gara e il trail, stabile in curva e comodo
- buona aderenza, declinato con varie tecnologie
- pneumatico scorrevole, il suo battistrada si adatta a qualsiasi terreno

**UN MODÈLE POLYVALENT DE PREMIÈRE CLASSE QUI A ÉGALEMENT FAIT SES PREUVES EN COMPÉTITION.**

- pneu versatile, aussi à l'aise en compétition que sur piste, très adhérent dans les virages et confortable
- bonne adhérence, avec plusieurs technologies disponibles
- roulement souple qui s'adapte à tous types de terrain grâce à une bande de roulement spéciale



ARTICLE	EAN	ETRTO	DIMENSION	COLOR/SIDEWALL	TECHNOLOGY	WEIGHT	BAR	MAX.BAR	PRICE (€)
<b>Cross-King 2.2 ProTecton</b>									
C0101483	4019238798036	55-559	26x2.2	black skin foldable	ProTecton	590g	3,0	4,0	67,90
C0101465	4019238798050	55-584	27.5x2.2	black skin foldable	ProTecton	620g	3,0	4,0	67,90
C0101965	4019238071474	55-584	27.5x2.2	black/transp. fold.	ProTecton	630g	3,0	4,0	67,90
C0101471	4019238798043	55-622	29x2.2	black skin foldable	ProTecton	660g	3,0	4,0	67,90
C0101966	4019238071467	55-622	29x2.2	black/transp. fold.	ProTecton	670g	3,0	4,0	67,90
<b>Cross King 2.2 ShieldWall</b>									
C0150303	4019238797480	55-559	26x2.2	black skin foldable	ShieldWall System	700g	3,0	4,0	36,90
C0150291	4019238797503	55-584	27.5x2.2	black skin foldable	ShieldWall System	740g	3,0	4,0	36,90
C0150295	4019238797497	55-622	29x2.2	black skin foldable	ShieldWall System	790g	3,0	4,0	36,90
<b>Cross King 2.3 ProTecton</b>									
C0101463	4019238798364	58-584	27.5x2.3	black foldable	ProTecton	730g	2,8	3,8	67,90
C0101475	4019238798418	58-622	29x2.3	black foldable	ProTecton	770g	2,8	3,8	67,90
<b>Cross King 2.3 ShieldWall</b>									
C0150302	4019238798319	58-559	26x2.3	black foldable	ShieldWall System	730g	2,8	3,8	36,90
C0150290	4019238798296	58-584	27.5x2.3	black foldable	ShieldWall System	780g	2,8	3,8	36,90
C0150297	4019238798326	58-622	29x2.3	black foldable	ShieldWall System	830g	2,8	3,8	36,90
<b>Cross King 2.6 ShieldWall</b>									
C0150337	4019238003581	65-584	27.5x2.60	black skin foldable	ShieldWall System	920g	2,0	3,0	40,99
C0150502	4019238037258	65-622	29x2.60	black skin foldable	ShieldWall System	995g	2,0	3,0	40,99
<b>Cross-King 2.6 ProTecton</b>									
C0101384	4019238773606	65-584	27.5x2.6	black foldable	ProTecton	810g	2,0	3,0	89,99
<b>Cross-King 2.8 ShieldWall</b>									
C0150336	4019238003611	70-584	27.5x2.80	black skin foldable	ShieldWall System	1040	1,8	2,8	40,99



## Mountain King

**SICURO A SPASSO TRA LA NATURA.** Il Mountain King dà il meglio di sé sulle biciclette da all mountain. La scolpita direzionale e antisdrucchiolevole lo rendono un ideale pneumatico anteriore, visto che i tasselli centrali mordono, mentre quelli laterali aderiscono ed offrono un buon grip su qualsiasi terreno. È il compagno perfetto per le uscite sportive.

**TRAVERSER LES TERRAINS EN TOUTE SÉCURITÉ.** Le Mountain King révèle ses qualités en All Mountain. Grâce à la géométrie ouverte et à bonne adhérence de son profil, c'est le pneu avant idéal. Le mordant de ses crampons médians et l'adhérence de ses crampons latéraux lui donne un très bon grip sur tous les terrains. Ce pneu est le compagnon idéal pour les virées sportives.



ARTICLE	EAN	ETRTO	DIMENSION	COLOR/SIDEWALL	TECHNOLOGY	WEIGHT	BAR	MAX.BAR	PRICE (€)
<b>Mountain King 2.3 ProTecton</b>									
C0101461	4019238798371	58-584	27.5x2.3	black skin foldable	ProTecton	730g	2,8	3,8	69,90
C0101469	4019238798432	58-622	29x2.3	black skin foldable	ProTecton	770g	2,8	3,8	69,90
<b>Mountain King III 2.3 ShieldWall</b>									
C0150301	4019238798333	58-559	26x2.3	black skin foldable	ShieldWall System	730g	2,8	3,8	36,99
C0150289	4019238798302	58-584	27.5x2.3	black skin foldable	ShieldWall System	770g	2,8	3,8	36,99
C0150294	4019238798340	58-622	29x2.3	black skin foldable	ShieldWall System	820g	2,8	3,8	36,99
<b>Mountain King 2.6/2.8 ShieldWall</b>									
C0150335	4019238003598	65-584	27.5x2.6	black skin foldable	ShieldWall System	935g	2,0	3,0	40,99
C0150334	4019238003628	70-584	27.5x2.8	black skin foldable	ShieldWall System	1020g	1,8	2,8	40,99
<b>Mountain King 2.6 ProTecton</b>									
C0101583	4019238003543	65-584	27.5x2.6	black foldable	ProTecton	810g	2,0	3,0	79,90



### Race King

**UN CLASSICO PER GLI AGONISTI.** Il Race King è un classico tipo da competizione. È gettonatissimo nelle gare di cross-country o nelle marathon e si addice sia alle front che alle full suspended. Spicca per la bassa resistenza al rotolamento, ha una carcassa voluminosa e un'ottima capacità di smorzare i colpi. Il battistrada garantisce i requisiti più utili per il biker assiduo.

**LE PREMIER CHOIX DES COUREURS.** Le Race King est le type même du classique de compétition. Ce pneu est utilisé dans les courses de cross country ou les marathons et est également adapté aux hardtails et aux races fulls. Il sait convaincre par sa faible résistance au roulement, sa carcasse volumineuse et son excellent amortis. Son profil offre les meilleures conditions aux cyclistes assidus.



ARTICLE	EAN	ETRTO	DIMENSION	COLOR/SIDEWALL	TECHNOLOGY	WEIGHT	BAR	MAX.BAR	PRICE (€)
<b>Race King 2.0 ShieldWall</b>									
C0150309	4019238797527	50-584	27.5x2.0	black foldable	ShieldWall System	630g	3,5	4,5	36,90
C0150307	4019238797534	50-622	29x2.0	black foldable	ShieldWall System	660g	3,5	4,5	36,90
<b>Race King 2.2 ProTaction</b>									
C0101486	4019238798111	55-559	26x2.2	black skin foldable	ProTaction	560g	3,0	4,0	67,90
C0101467	4019238798135	55-584	27.5x2.2	black skin foldable	ProTaction	590g	3,0	4,0	67,90
C0101962	4019238071504	55-584	27.5x2.2	black/transp. fold.	ProTaction	590g	3,0	4,0	67,90
C0101473	4019238798128	55-622	29x2.2	black skin foldable	ProTaction	620g	3,0	4,0	67,90
C0101963	4019238071498	55-622	29x2.2	black/transp. fold.	ProTaction	630g	3,0	4,0	67,90
<b>Race King 2.2 ShieldWall</b>									
C0150304	4019238797541	55-559	26x2.2	black skin foldable	ShieldWall System	660g	3,0	4,0	36,99
C0150292	4019238797565	55-584	27.5x2.2	black skin foldable	ShieldWall System	700g	3,0	4,0	36,99
C0150296	4019238797558	55-622	29x2.2	black skin foldable	ShieldWall System	740g	3,0	4,0	36,99



### Tubeless Ready

Il nostro pneumatico Tubeless Ready [TR] può essere usato con camera d'aria o liquido sigillante. Pneumatico e cerchio sono disegnati in modo che quando sono usati assieme si sigillano facilmente. Per motivi di sicurezza usiamo solo ruote progettate per essere Tubeless Ready. Gli pneumatici TR hanno un ulteriore design alleggerito. I loro fianchi sono meno permeabili all'aria e sono sigillati con uno speciale sigillante, per esempio il Conti RevoSealant.

Les pneus Tubeless Ready peuvent être utilisés au choix avec ou sans chambre à air. Pour être utilisé sans chambre à air, le pneu doit être étanchéifié avec un liquide préventif. Le talon révolutionnaire Tubeless Ready permet un montage simple du pneu sur la jante. Tous les pneus VTT Continental des gammes ProTecton et Performance sont Tubeless Ready. Pour un résultat d'étanchéité parfaite, nous recommandons l'utilisation du préventif Continental RevoSealant.



### Adatto alle E-Bikes / Adapté aux E-Bikes

Per il nostro pneumatico per e-Bike ereditiamo gli oltre cento anni di esperienza con gli pneumatici per ciclomotori e moto. Tutti i nostri pneumatici da città/trekking hanno una velocità standard di almeno 25 km/h. Gli pneumatici siglati "e50" sono certificati anche per S-Pedelecs. La loro struttura di alta qualità assicura elevata protezione contro le forature, bassa resistenza al rotolamento e aggiunge un'alta durezza, grazie alla porzione motrice con struttura maggiorata.

Pour mettre au point notre pneu E-Bike nous avons tiré profit de notre expérience de plus de 100 ans dans le domaine du pneu cyclomoteur et moto. Tous nos pneus pour vélos de ville et trekking ont été conçus en fonction d'une vitesse minimum de 25 km/h. Ces pneus portant l'indication e50 sont également certifiés pour S-Pedelecs. Avec leur structure de haute qualité, la protection contre les crevaisons est élevée et la résistance au roulement faible préservant ainsi le pneu d'une usure prématurée créée par la force d'entraînement supplémentaire.



**Continental**



## ProTecton

**PER LA STRADA PIÙ DIFFICILE.** Le nuove carcasse Continental ProTecton sono state ulteriormente migliorate: la fettuccia anti-foratura è stata applicata in modo uniforme su tutto l'arco di circonferenza dello pneumatico, così da renderlo particolarmente resistente alle lesioni e alle perforazioni di corpi estranei. Rispetto ai già apprezzati predecessori in DuraSkin® le carcasse ProTecton pesano il 25 per cento in meno e offrono il 30 per cento di protezione in più dalle forature. Migliorate sono anche la resistenza al rotolamento e le capacità di assorbire i colpi, che completano le qualità assolute della tecnologia "made in Germany" di questi prodotti. Versatili e universali, le carcasse ProTecton convincono anche grazie alla mescola BlackChili Compound e al design accattivante dei fianchi. Il nuovo tallone Revolution permette di utilizzarle come coperture tubeless ready; in questo caso per ottenere la migliore efficienza è consigliato l'utilizzo del nuovo sigillante Continental RevoSealant.

**LA MANIÈRE FORTE.** Les nouvelles carcasses Continental ProTecton n'ont jamais eu aussi belle allure. La bande de protection supplémentaire contre la crevaison la rend particulièrement résistante et insensible aux lésions ou à la pénétration de corps étrangers. Bande de roulement et flancs sont protégés de la même manière. Elles sont pourtant plus légères de 25% et assurent une protection anti-crevaison supérieure de 30% par rapport à leurs prédécesseurs armés de DuraSkin®. Par ailleurs, elles améliorent une fois de plus la résistance au roulement et l'amortissement. La nouvelle technologie "made in Germany" leur permet même de résister aux "trails" les plus durs du monde. Et elles ont encore un atout en poche: d'usage universel, elles séduisent de surcroît par le BlackChili Compound et le design attrayant des flancs. Le nouveau talon Revolution Tubeless Ready facilite l'utilisation en pneu Tubeless Ready. Pour des résultats idéaux de colmatage et de mise en oeuvre, nous recommandons d'utiliser le nouveau produit d'étanchéité Continental RevoSealant.



## ShieldWall System

**SISTEMA TUBELESS-READY E PROTEZIONE CONTRO LE FORATURE PER BIKER CON UN BUDGET LIMITATO.** Il sistema ShieldWall unisce in modo ottimale alta protezione contro le forature, bassa resistenza al rotolamento e peso contenuto. Questo grazie a un ulteriore strato di protezione totale contro le forature, costituito da un tessuto con trama finemente intrecciata. Questo conferisce allo pneumatico elevata resistenza contro forature e lacerazioni. Nonostante il tessuto aggiuntivo, lo pneumatico ha ottime proprietà di smorzamento dei colpi e un alto grado di flessibilità per adattarsi perfettamente al terreno. Il rivoluzionario tallone tubeless ready permette un'installazione facile e semplice dello pneumatico. Per ottenere i migliori risultati nella sigillatura e nell'utilizzo si consiglia l'uso del sigillante Continental RevoSealant.

**TUBELESS READY OFFRE LA PROTECTION CONTRE LA CREVAISON POUR LES CYCLISTES ATTENTIFS À LEUR BUDGET.** Le ShieldWall system se caractérise par la combinaison optimale d'une haute protection contre les crevaisons et d'une faible résistance au roulement, avec un faible poids. Ceci est rendu possible grâce à une couche supplémentaire de protection en tissu finement tressé. Cela donne au pneu une grande résistance aux crevaisons et aux coupures. Malgré sa couche supplémentaire, le pneu a une très bonne capacité d'amortissement et un degré élevé de souplesse pour s'adapter à tout type de terrain. Le révolutionnaire tubeless ready permet un montage du pneu simple et facile. Pour obtenir de meilleurs résultats en matière d'étanchéité et d'utilisation, nous recommandons l'utilisation du nouveau produit d'étanchéité Continental RevoSealant sealant.



## Performance

**QUALITÀ DI FIDUCIA.** PureGrip è la tecnologia di mescola utilizzata esclusivamente sulle coperture destinate alle alte prestazioni. Il nome parla da solo e unisce un'aderenza superiore e grande durezza. Non lasciare mai nessun ciclista nei guai è stato uno dei principali obiettivi a cui si è puntato nel momento in cui questa nuova mescola è stata sviluppata e poi prodotta, presso il nuovo stabilimento Continental in Cina. La Performance è applicata su una robusta carcassa in nylon da 60 TPI (fili per pollice) in modo da consegnare una copertura affidabile, resistente e adatta a chiudere a tenuta lo pneumatico di tipo tubeless, senza camera d'aria, assieme al liquido sigillante Conti RevoSealant. Da parte loro, i talloni pieghevoli in morbida ma robusta aramide assicurano una tenuta salda sul cerchio. Gli pneumatici con mescola Performance sono qualitativamente allineati agli articoli similari prodotti dalla concorrenza asiatica, per questo offrono al bike dilettante ed ambizioso una conveniente alternativa siglata "Continental".

**UNE QUALITÉ FIABLE.** PureGrip est une technologie mixte issue de la dernière gamme de qualité performance. Son nom des plus éloquentes n'est pas sans évoquer accroche et longévité. Particulièrement solide et adhérent, le mélange de caoutchouc est l'allié idéal de tout cycliste, une caractéristique qui répond ainsi à l'un des objectifs principaux fixés pour le développement de ce produit de la nouvelle usine chinoise de Continental. Grâce à une robuste carcasse en nylon 60 TPI allié à du caoutchouc haute qualité, cette technologie permet une emprise excellente et un colmatage tubeless des pneus à l'aide du RevoSealant "Tubeless Ready" de Conti. La tenue sur la jante est garantie par une tringle souple en aramide. Grâce à ces matériaux de pointe, ces pneus peuvent se mesurer à leurs concurrents asiatiques tout en représentant pour les ambitieux amateurs de vélo une alternative peu onéreuse signée Continental.



# URBAN TOUR





### CONTACT Speed

**UNO PNEUMATICO ALL'ALTEZZA DI OGNI SFIDA, CON LA VELOCITÀ COME PUNTO DI FORZA.** Contact Speed è uno slick ad alta tenuta, con battistrada micropuntinato che si distingue particolarmente sull'asfalto. Grazie ad esso le city bike, le single speed e le fitness bike godranno al contempo del suo dinamismo e di un elevato grado di comfort. Oltre che per il particolare battistrada Contact Speed convince per il suo grip, per la sua scorrevolezza e la doppia protezione contro le forature.

**ALLIE CONFORT ET VITESSE.** Son avantage est la vitesse. Le slick antipatinage avec profil rugueux est particulièrement adapté à l'asphalte. Les vélos de ville, à pignon fixe et d'entraînement profitent de sa dynamique tout en fournissant un grand confort. Ce pneu est ainsi en mesure de relever tous les défis. En plus de son nouveau design Vulcanette, le CONTACT Speed se distingue par son grip, sa fluidité et sa double protection anti-crevaisson.



### CONTACT Plus

**LA COMBINAZIONE ULTIMA.** Un pneumatico polivalente su qualsiasi tipo di strada o percorso che valorizza ogni bicicletta. Grazie all'aggiunta della protezione antiforatura, nessuno rimarrà indietro con una gomma a terra. Insieme alla camera d'aria Hermetic Plus, è un prodotto assolutamente senza preoccupazioni.

**LA COMBINAISON ULTIME.** Un pneu polyvalent pour tous types de routes ou de chemins qui améliore chaque vélo. Grâce à l'ajout d'une protection contre les crevaisons, personne ne sera laissé avec un pneu à plat. Associé à la chambre à air Hermetic Plus, c'est un produit totalement sans souci.



ARTICLE	EAN	ETRTO	DIMENSION	COLOR/SIDEWALL	TECHNOLOGY	WEIGHT	BAR	MAX.BAR PRICE (€)
<b>CONTACT Speed</b>								
C0101412	4019238774559	37-622	28x1 3/8x1 5/8	black wire skin	Double SafetySystemBreaker	500g	5,0 6,0	32,90
C0101416	4019238774504	42-622	700x42 C (40 C)	black wire skin	Double SafetySystemBreaker	590g	3,5 6,0	32,90
<b>CONTACT Plus</b>								
C0101002	4019238639964	47-559	26x1.75	black reflex wire skin	SafetyPlusBreaker	1040g	3,0 4,0	42,99
C0101004	4019238639940	32-622	28x1 1/4x1 3/4	black reflex wire skin	SafetyPlusBreaker	750g	5,0 6,0	42,99
C0101005	4019238639933	37-622	28x1 3/8x1 5/8	black reflex wire skin	SafetyPlusBreaker	980g	4,0 6,0	42,99
C0101006	4019238639926	42-622	28x1.6	black reflex wire skin	SafetyPlusBreaker	1050g	3,5 5,0	42,99





### RIDE Tour

**COMPAGNO AFFIDABILE PER IL CICLOTURISMO.** Ride Tour è a proprio agio su ogni tipo di fondo, è un vero polivalente. La banda centrale del battistrada ha un design continuo, a garanzia di buone proprietà di rotolamento. Ulteriori punti di forza? L'ampia gamma di colori, di sezioni e la durata elevata.

**UN COMPAGNON FIABLE EN RANDONNÉE.** Le RIDE Tour est chez lui sur tous les terrains, c'est un véritable multitalent. Sa surface de roulement médiane continue assure de bonnes propriétés de roulement et offre en même temps suffisamment de traction ainsi qu'une grande sûreté dans les virages. Nos clients profitent de la vaste palette de tailles disponibles et de sa grande capacité de kilométrage.



ARTICLE	EAN	ETRTO	DIMENSION	COLOR/SIDEWALL	TECHNOLOGY	WEIGHT	BAR	MAX.BAR	PRICE (€)
<b>RIDE Tour</b>									
C0101148	4019238693553	47-559	26x1.75	black wire skin	Extra Puncture Belt	780g	3,0	4,0	21,99
C0101151	4019238693522	28-622	700x28C (700C)	black wire skin	Extra Puncture Belt	540g	5,0	5,5	21,99
C0101153	4019238693508	32-622	700x32C	black wire skin	Extra Puncture Belt	640g	5,0	5,5	21,99
C0101155	4019238693485	37-622	700x35C	black wire skin	Extra Puncture Belt	690g	4,0	5,0	21,99
C0101157	4019238693478	42-622	700x42C (40C)	black wire skin	Extra Puncture Belt	790g	3,5	4,5	21,99



### SafetyPlus Breaker

#### LO SPECIALISTA TRA I BREAKER

Sviluppato specialmente per le e-bike fino a 50 km/h, combiniamo il nostro SafetySystem Breaker con una gomma ad alta flessibilità. Il risultato è un Breaker estremamente resistente ai tagli e alle perforazioni, con una resistenza al rotolamento sorprendentemente bassa, grazie alla sua elevata elasticità. Questo conserva l'energia e l'inerzia. L'accelerazione rapida così come l'alta velocità di esecuzione delle curve non sono un problema per il Breaker. È lo specialista per le e-bike veloci e per le bici a noleggio.

#### LE SPÉCIALISTE POUR LES E-BIKES

Pour les E-bikes, nous avons combiné le SafetySystem Breaker avec un matériau hautement élastique. Le résultat est une enveloppe extrêmement résistante aux coupures et aux crevaisons qui, grâce à sa grande élasticité, offre surtout une faible résistance au roulement, économisant la batterie et l'environnement. Il est également conforme aux exigences de plus grande vitesse des E-bikes, pouvant aller jusqu'à 50 km/h. Il est également adapté pour le couple d'accélération plus élevé des vélos électriques ainsi que les vitesses plus rapides dans les virages. Le pneu spécial pour les E-bikes rapides et les vélos de locations.

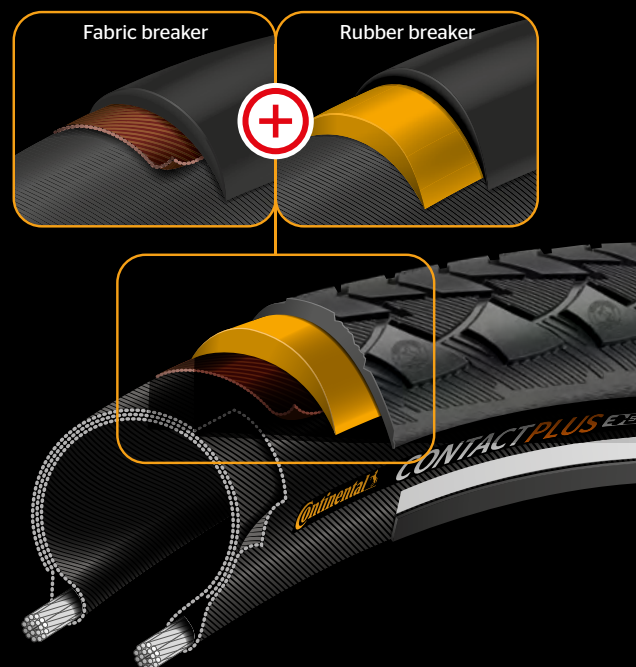

Fino al **30 % in più di maggiore protezione\*** contro le perforazioni di sassi e pietre acuminata!

\*Test comparativo di resistenza alla foratura (al taglio), Istituto di Zedlere 2016.  
Per maggiori informazioni visita <http://www.continental-tires.com/bicycle/technology>

Jusqu'à **30% plus résistant** à l'intrusion de tessons et de silex\*

\*Test comparatif de résistance aux perforations (lame), Institut Zedler 2016.  
Pour plus d'informations, visitez <http://www.continental-tires.com/bicycle/technology>

### EXTRA PunctureBelt

Assieme ai fianchi in gomma rinforzata questa fettuccia costituisce un'elevata protezione contro forature e abrasioni. Disponibile in versione di pneumatico compatto con una forte propensione per la durezza.

Tous ceux qui recherchent un compagnon de tous les jours fiable choisiront un pneumatique avec EXTRA PunctureBELT. Ce dispositif de sécurité en caoutchouc robuste, combiné avec les flancs du pneu renforcés de caoutchouc, assure un haut niveau de protection contre les crevaisons et l'abrasion des flancs. Lorsque la longévité est l'objectif principal, il existe également une version pneu plein.

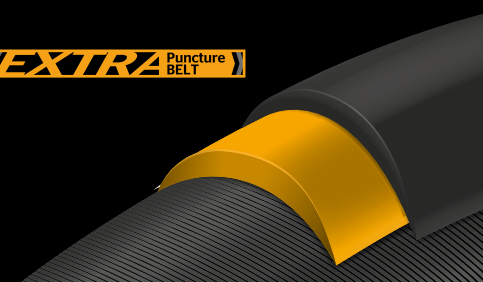

# ACCESSORIES



I piccoli dettagli fanno la differenza. Che si tratti di montare lo pneumatico sul cerchio o di riparare una foratura, che sia in strada o nell'officina di casa, le tue coperture necessitano del migliore servizio e del miglior supporto. Nella prossima pagina troverai utili accessori che ti aiuteranno il più possibile a risolvere gli aspetti pratici del tuo sport senza problemi. Dalla giusta camera d'aria ai giusti cerchi passando per gli adeguati levagomme e per i sigillanti efficienti, noi abbiamo sempre qualcosa di utile per il tuo prossimo progetto.

Les petits détails font la différence. Qu'il s'agisse de monter le pneu sur la jante ou d'effectuer de petites réparations, au bord de la route comme à la maison, vous pouvez être sûr que vos pneus bénéficieront du meilleur service et d'une assistance adéquate. Dans la page suivante, vous trouverez des accessoires très utiles pour rendre les aspects techniques de la pratique sportive aussi agréables que possible. Vous cherchez un modèle spécifique, des jantes adaptées à votre vélo, un démonte-pneu pratique ou un produit anti-crevaisson efficace ? Nous avons ce qu'il vous faut!

ARTICLE	EAN	DESCRIPTION	ETRTO	DIMENSION	PRICE (€)
<b>MTB Bicycle Tubes</b>					
C0181631	4019238556711	<b>MTB 26</b>	47-559 > 62-559	S42	8,99
C0182311	4019238619591	<b>MTB 27.5</b>	47-584 > 62-584	S42	8,99
C0180015	4019238008067	<b>MTB 27.5</b>	65-584 > 70-584	S42	10,99
C0182181	4019238557084	<b>MTB 28 / 29 inch</b>	47-622 > 62-662	S42	8,99
C0182191	4019238557091	<b>MTB 28 / 29 inch</b>	47-622 > 62-662	S60	9,99
<b>Tour Bicycle Tubes</b>					
C0182031	4019238556940	<b>Tour 28 all</b>	32-622 > 47-622	S42	8,99
<b>Cross Bicycle Tubes</b>					
C0181941	4019238556872	<b>Cross Tube 28</b>	32-622 > 47-622	S42	8,99
C0181951	4019238556889	<b>Cross Tube 28</b>	32-622 > 47-622	S60	9,99
<b>Race Bicycle Tubes</b>					
C0181781	4019238556780	<b>Race 28</b>	20-622 > 25-630	S42	8,99
C0181791	4019238556797	<b>Race 28</b>	20-622 > 25-630	S60	9,99
C0180000	4024066568133	<b>Race 28</b>	20-622 > 25-630	S80	10,99
C0181821	4019238556803	<b>Race 28 Light</b>	20-622 > 25-630	S42	10,99
C0181831	4019238556810	<b>Race 28 Light</b>	20-622 > 25-630	S60	12,99
C0181871	4019238556827	<b>Race 28 Light</b>	20-622 > 25-630	S80	13,99
C0181881	4019238556834	<b>Race 28 Supersonic</b>	20-622 > 25-630	S42	19,50
C0181891	4019238556841	<b>Race 28 Supersonic</b>	20-622 > 25-630	S60	19,50
C0181921	4019238556858	<b>Race 28 Wide</b>	20-622 > 25-630	S42	8,99
C0181931	4019238556865	<b>Race 28 Wide</b>	20-622 > 25-630	S60	9,99



ARTICLE	EAN	DESCRIPTION	WEIGHT	PRICE (€)
<b>Tubular kit</b>				
C0149091	4019238105322	Rim cement for aluminium	tube 25g	5,50
C0149092	4019238105339	Rim cement for aluminium	can 350g	33,90
C0140016	4024066441405	Rim cement for carbon rims	tube 25g	5,50
C0140017	4024066441412	Rim cement for carbon rims	can 200g	24,90
<b>Tube bag</b>				
C0100388	4024066508061	Tube bag with Race 28 S42 tube and 2 tire lever race	160g	12,99
C0101026	4024066653112	Tube bag with MTB 29 tube S42 and 2 tire levers MTB	320g	12,99
<b>Sealant</b>				
C0140044	4019238558913	Continental RevoSealant	240ml	14,90
C0140050	4019238585278	Continental RevoSealant	1.000ml	38,90
<b>Valve extension</b>				
C0149690	4019238105353	Exchangeable presta valve insert (bag of 10 pcs)	10 pcs	10,00
C0140030	4024066549170	Valve extension for presta valve aluminium 30mm, 2pcs	30mm	14,90
C0140032	4024066549194	Valve extension for presta valve aluminium 40mm, 2pcs	40mm	14,90
C0140034	4024066549217	Valve extension for presta valve aluminium 60mm, 2pcs	60mm	15,90

# BROOKS

18 ENGLAND 66





**BROOKS ENGLAND**



# **Cambium saddles**



IMMEDIATE COMFORT

**All Rides. All Roads. All Weathers.**



**Resistenti alle intemperie, durevoli e comode fin da subito, le selle Brooks England Cambium combinano materiali e tecnologie d'avanguardia con un intramontabile impegno nei confronti della qualità.**

La sella Cambium è pronta ad affrontare ogni condizione atmosferica e qualsiasi strada, grazie allo strato in gomma naturale applicato su una struttura tanto essenziale quanto solida, progettata per muoversi assieme a te e realizzata secondo gli stessi standard di design senza tempo che hanno reso famose le selle Brooks England. Le straordinarie proprietà della gomma naturale sono pronte a ispirare una nuova generazione di cicliste e ciclisti intrepidi.

Resistente ai raggi UV, alle abrasioni,  
Cover in nylon impermeabile.



Rivetti in resistente  
alluminio anodizzato.

La gomma naturale vulcanizzata  
offre un livello unico di comfort.



Punta del naso e supporto posteriore  
in nylon rinforzato con fibra di vetro.



**45°**  
RIDING POSITION

**C13 145mm**  
L275 x W145 x H55 mm



**C13 Carved 145mm**  
L275 x W145 x H55 mm



C13 DETAILS

145 MM



158 MM

ARTICLE	UPC/EAN	MODEL	TOP	STRUCTURE	WEIGHT	PRICE (€)
C203M00A06300	190445015353	<b>C13 145mm</b>	Black	Carbon Frame	295g	200
C203MCOA06300	190445015391	<b>C13 Carved 145mm</b>	Black	Carbon Frame	280g	200



**45°**  
RIDING POSITION

**C13 158mm**

L275 x W158 x H55 mm



**C13 Carved 158mm**

L275 x W158 x H55 mm



**C13 DETAILS**

NYLON TOP

VULCANISED NATURAL RUBBER

7X9 MM CARBON FRAME



ARTICLE	UPC/EAN	MODEL	TOP	STRUCTURE	WEIGHT	PRICE (€)
C203W00A06300	190445016305	<b>C13 158mm</b>	Black	Carbon Frame	310g	200
C203WC0A06300	190445016312	<b>C13 Carved 158mm</b>	Black	Carbon Frame	295g	200



**45°**  
RIDING POSITION

**C15**  
L283 x W140 x H52 mm



**C15 Carved**  
L283 x W140 x H52 mm



C15 DETAILS

STANDARD



CARVED

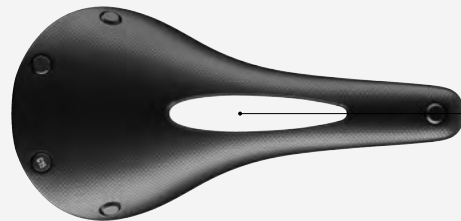

ARTICLE	UPC/EAN	MODEL	TOP	STRUCTURE	WEIGHT	PRICE (€)
C205000A06300	190445013861	<b>C15</b>	Black	Nose-piece and Saddleplate in Fibreglass Reinforced Nylon & Steel Rail	450g	130
C205C00A06300	190445013878	<b>C15 Carved</b>	Black	Nose-piece and Saddleplate in Fibreglass Reinforced Nylon & Steel Rail	432g	130



**60°**  
RIDING POSITION

**C17**  
L283 x W164 x H52 mm



**C17 Carved**  
L283 x W164 x H52 mm



**C17 CARVED DETAILS**

STEEL RAIL



NOSE-PIECE AND SADDLEPLATE  
IN FIBREGLASS REINFORCED NYLON

ARTICLE	UPC/EAN	MODEL	TOP	STRUCTURE	WEIGHT	PRICE (€)
C201000A06300	190445013847	<b>C17</b>	Black	Nose-piece and Saddleplate in Fibreglass Reinforced Nylon & Steel Rail	464g	130
C201C00A06300	190445013854	<b>C17 Carved</b>	Black	Nose-piece and Saddleplate in Fibreglass Reinforced Nylon & Steel Rail	446g	130



**60°**  
RIDING POSITION

**NEW COLOR**

**C17 Colored Top**  
L283 x W164 x H52 mm



**C17 Colored Top**  
L283 x W164 x H52 mm



**C17 Colored Top**  
L283 x W164 x H52 mm



**C17 Colored Top**  
L283 x W164 x H52 mm

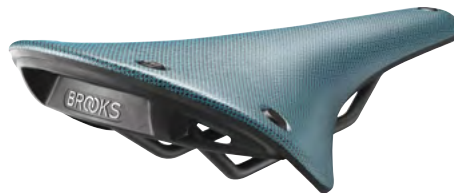

ARTICLE	UPC/EAN	NEW	MODEL	NYLON TOP	STRUCTURE	WEIGHT	PRICE (€)
C201000A06305	8021890552440	<b>NEW</b>	<b>C17</b>	Brown	Nylon Top, Nose-Piece and Saddleplate in Fibreglass Reinforced Nylon & Steel Rail	464g	130
C201000A00401	190445017555			Mud Green		464g	130
C201000A06317	190445016275			Bronze Orange		464g	130
C201000A06354	190445016282			Octane		464g	130

**NEW**

**C17 Carved Colored Top**  
L283 x W164 x H52 mm



**NEW**

**C17 Carved Colored Top**  
L283 x W164 x H52 mm



**NEW**

**C17 Carved Colored Top**  
L283 x W164 x H52 mm



**NEW**

**C17 Carved Colored Top**  
L283 x W164 x H52 mm



ARTICLE	UPC/EAN	NEW	MODEL	NYLON TOP	STRUCTURE	WEIGHT	PRICE (€)
C201C00A06305	8021890588111	<b>NEW</b>	<b>C17 Carved</b>	Brown	Nose-piece and Saddleplate in Fibreglass Reinforced Nylon & Steel Rail	446g	130
C201C00A00401	8021890588104	<b>NEW</b>		Mud Green		446g	130
C201C00A06317	8021890588128	<b>NEW</b>		Bronze Orange		446g	130
C201C00A06354	8021890588135	<b>NEW</b>		Octane		446g	130





**60°**  
RIDING POSITION

**C17 Special**  
ORGANIC COTTON  
L283 x W164 x H52 mm



**NEW COLOR**

**C17 Special**  
ORGANIC COTTON  
L283 x W164 x H52 mm



**NEW COLOR**

**C17 Special**  
ORGANIC COTTON  
L283 x W164 x H52 mm

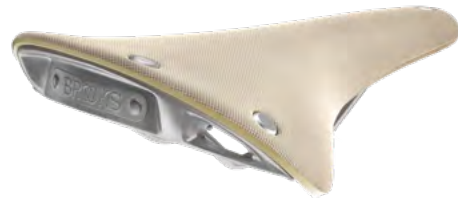

ARTICLE	UPC/EAN	NEW	MODEL	ORGANIC TOP	STRUCTURE	WEIGHT	PRICE (€)
C211000A06001	190445010273			Black/Natural Rubber		436g	160
C211000A56000	190445016329	<b>NEW</b>	<b>C17 Special</b>	Black/Black Rubber with Copper Rivets	Vulcanised Rubber & Organic Cotton Top, Nose-Piece and saddleplate in Aluminium Structure & Tubular Steel Rails	436g	160
C211000A06015	190445002766	<b>NEW</b>		Organic (Aluminium Frame) Natural/Natural Rubber		436g	160



**90°**  
RIDING POSITION

**C19**

L275 x W184 x H57 mm



**C19 Carved**

L275 x W184 x H57 mm



**C19 CARVED DETAILS**

NYLON TOP

STEEL RAIL



VULCANISED NATURAL RUBBER

ARTICLE	UPC/EAN	MODEL	TOP	STRUCTURE	WEIGHT	PRICE (€)
C209000A06300	190445013885	<b>C19</b>	Black	Nose-piece and Saddleplate in Fibreglass Reinforced Nylon & Steel Rail	490g	130
C209C00A06300	190445013892	<b>C19 Carved</b>	Black	Nose-piece and Saddleplate in Fibreglass Reinforced Nylon & Steel Rail	473g	130

# C67

CLASSIC EXTRA WIDE PROFILE FOR STABILITY  
AND COMFORT IN AN UPRIGHT CYCLING POSITION

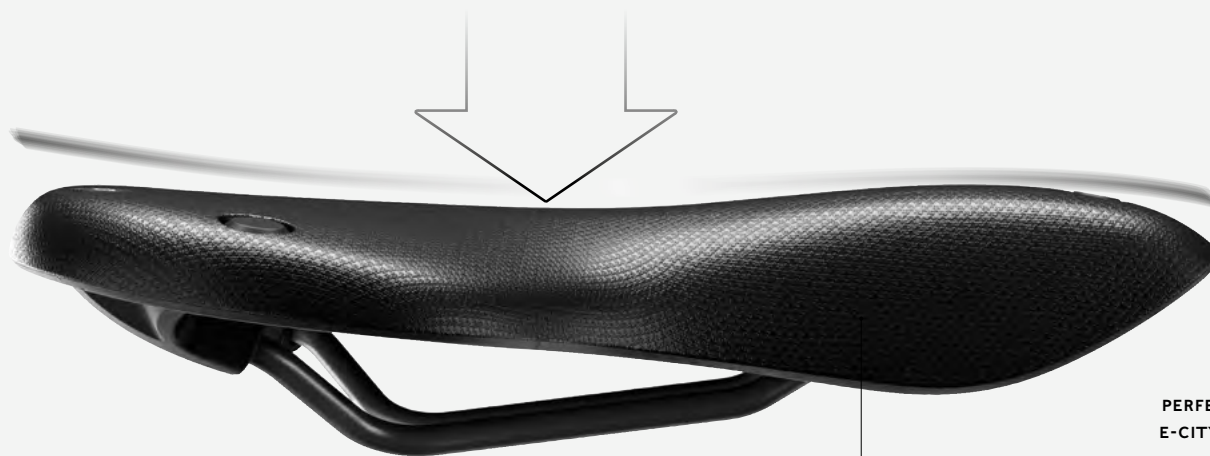

PERFECT ALSO FOR  
E-CITY AND CARGO

PERFECT FOR CITY / TREKKING  
(COMMUTER & TOURING)

## La nostra Cambium più larga per una posizione eretta ideale per gli spostamenti in città

La C67 è stata progettata pensando a chi va al lavoro in bicicletta, a chi pedala in città e a chi lo fa per svago e desidera una posizione di guida eretta. È resistente alle intemperie e quindi perfetta per pedalare in qualsiasi condizione atmosferica. Realizzata in gomma naturale vulcanizzata, la C67 si muove assieme al tuo corpo per fornirti un sostegno duraturo fin da subito, senza bisogno di un periodo di rodaggio. La parte posteriore più ampia, la forma curva e la base in gomma flessibile offrono un'elevata stabilità, nonché il massimo controllo durante l'accelerazione della e-bike. La sua struttura a ventaglio in nylon rinforzato con fibra di vetro aggiunge resistenza alle sollecitazioni e alle vibrazioni, mentre l'intelligente impugnatura in gomma della piastra posteriore interna garantisce una presa solida e stabile quando cammini con la tua e-bike, bici cargo o bici olandese.



**90°**  
RIDING POSITION

**C67**  
L268 x W200 x H59 mm



La C67 è caratterizzata da un'ampia area di appoggio, che garantisce un elevato comfort nella seduta a 90 gradi e stabilità data dalla punta più ampia. Il top della sella è realizzato al 100% in gomma vulcanizzata, che flettendosi garantisce l'effetto "amaca" di Brooks, permettendo una seduta naturale e un buon supporto alle ossa ischiatiche.

**E-Shape:** l'effetto amaca del top in gomma naturale e la posizione rialzata permettono di evitare lo scivolamento all'indietro, mentre la punta più pronunciata garantisce maggiore stabilità.

**E-Grip:** la zona posteriore permette di avere una presa stabile per condurre o spostare agevolmente la bici quando si è in piedi.

#### C67 DETAILS

VULCANISED NATURAL RUBBER SADDLE TOP,  
UV + ABRASION RESISTANT WATERPROOF  
NYLON TOP & FLEXIBLE SURFACE

METAL LOGO PLAQUE

WIDE SURFACE 200MM WIDTH



INNOVATIVE FAN STRUCTURE  
IN FIBREGLASS REINFORCED NYLON

RUBBERISED GRIP FOR STRONG  
AND STABLE HOLD

ARTICLE	UPC/EAN	MODEL	TOP	STRUCTURE	WEIGHT	PRICE (€)
SCM67NYA00000	190445017562	<b>C67</b>	Black	Nylon Top, Nose-Piece and Saddleplate in Fibreglass Reinforced Nylon & Steel Rail	485g	130

# BAR TAPE & GRIPS

FIT FOR CAMBIUM SADDLES



I nastri manubrio e le manopole Brooks sono realizzati con materiali di alta qualità, garantendo un ottimo comfort d'appoggio. Resistenti e versatili sono il complemento perfetto per ogni sella Brooks.

**Ergonomic Rubber Grips**

130/130, 130/100 or 100/100 mm



ERGONOMIC  
COMFORT



HARD-WEARING



UNIQUE  
PREMIUM DETAILS



130/130 mm



130/100 mm



100/100 mm

**Cambium Rubber Grips**

130/130 or 130/100



COMFORTABLE  
TO THE TOUCH



HARD-WEARING



ADJUSTABLE



130/130 mm

130/100 mm

**NEW**

ARTICLE	UPC/EAN	NEW	MODEL	COLOR	DESCRIPTION	PRICE (€)
CSG6LLOA01000	8021890569912		<b>Ergonomic Rubber Grips</b>	Black	130/130 mm	60
CSG6LSOA01000	8021890569936			Black	130/100 mm	60
CSG6SSOA01000	8021890569950			Black	100/100 mm	60
CSG5LLOA01000	8021890569851		<b>Cambium Rubber Grips</b>	Black	130/130 mm	45
CSG5LLOA16015	8021890569868			Natural	130/130 mm	45
CSG5LSOA01000	8021890569875			Black	130/100 mm	45
CSG5LSOA16015	8021890569882	<b>NEW</b>		Natural	130/100 mm	45

## Cambium Rubber Bar Tape

Textured 3mm Comfort Padding



COMFORTABLE  
TO THE TOUCH



HARD-WEARING



ALL-SURFACE  
ABSORPTION

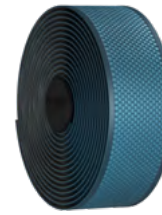
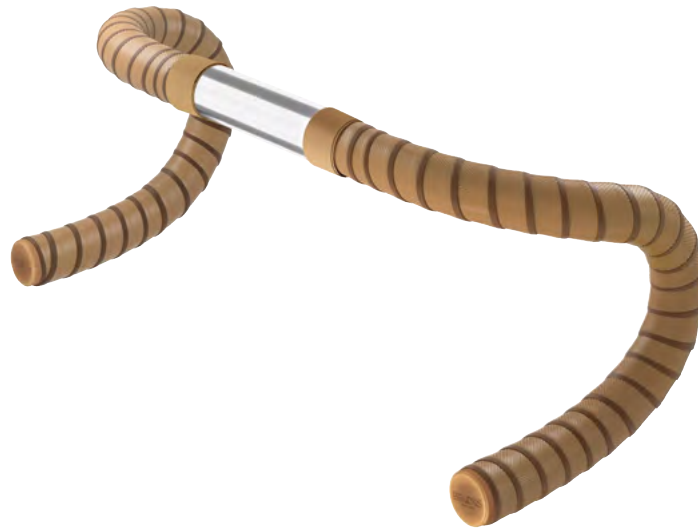

ARTICLE	UPC/EAN	MODEL	COLOR	DESCRIPTION	PRICE (€)
CT03000A16100	8021890569981		Black		45
CT03000A16115	8021890570017		Natural/Rubber		45
CT03000A16105	8021890569998	<b>Cambium Rubber Bar Tape</b>	Brown	Textured 3mm Comfort Padding	45
CT03000A10401	8021890569974		Mud Green		45
CT03000A16117	8021890570024		Bronze Orange		45
CT03000A16154	8021890570031		Octane		45





# MATCHING OPPORTUNITIES

FOR CAMBIUM RANGE

C17



C17 Special  
ORGANIC COTTON



C67



**C67**  
L268 x W200 x H59 mm

**Ergonomic  
Rubber Grips**  
130/130, 130/100 or 100/100 mm

C17 Carved  
Colored Top  
BROWN



C17 Carved  
Colored Top  
MUD GREEN



C17 Carved  
Colored Top  
BRONZE ORANGE



C17 Carved  
Colored Top  
OCTANE



**C17 Carved**  
L283 x W164 x H52 mm

**NEW**

**Cambium  
Rubber Grips**  
130/130 or 130/100

**Cambium  
Rubber Bar Tape**  
Textured 3 mm Comfort Padding



# **Leather saddles**

NATURALLY TIMELESS

Made by Hand. **Shaped by You.**



**Le selle in pelle di Brooks England sono realizzate con maestria nella fabbrica di Smethwick, in Inghilterra, e plasmate dai viaggi di innumerevoli cicliste e ciclisti in tutto il mondo, offrendo un comfort personalizzato da oltre 150 anni.**

Realizzate a mano con pelli di prima qualità conciate al vegetale, sono naturalmente comode ed elastiche, in modo da adattarsi perfettamente alla forma del corpo di chi le usa. Comodità e durevolezza per tutta la vita sono garantite grazie a un approccio totalmente naturale e finalizzato a fornire il miglior supporto possibile a chi va in bicicletta. Costantemente perfezionate e migliorate fin dai brevetti originali del XIX secolo, le selle Brooks England hanno oggi raggiunto uno status iconico, grazie alla loro qualità comprovata da molteplici generazioni di cicliste e ciclisti. Ogni sella è realizzata da artigiani appassionati, con pelli selezionate di altissima qualità, modellate e rifinite a mano e garantite per 10 anni dalla data di acquisto.



Il top in cuoio è sospeso sopra il telaio metallico per creare l'effetto di un'amaca e consentire movimenti naturali.

L'esclusivo top in cuoio si modellerà e si adatterà al tuo corpo nel corso del tempo, offrendo un comfort superiore.

I distintivi marchi impressi ai lati identificano i nostri modelli iconici.

I nostri durevoli rivetti in rame sono montati a mano e rifiniti da abili artigiani.

L'iconica targhetta Brooks è un marchio di fabbrica di qualità da oltre 150 anni.



**45°**  
RIDING POSITION

**Swift**

L272 x W150 x H72 mm



**Swallow**

L285 x W153 x H62 mm



SWIFT DETAILS

HAND FINISHED COPPER RIVETS



A CLASSIC SLIM PROFILE LEATHER TOP  
FOR A FORWARD RIDING POSITION

ARTICLE	UPC/EAN	MODEL	LEATHER TOP	METAL STRUCTURE	WEIGHT	PRICE (€)
B360H00A17202	831273006037	<b>Swift</b>	Black	Chrome Steel Rail & Hand Hammered Copper Rivets	510g	190
B360H00A17203	831273006044		Honey		510g	190
B360H00A17205	831273006051		Antique Brown		510g	190
B354000A17202	831273006006	<b>Swallow</b>	Black	Chrome Steel Rail	490g	190
B354000A17203	831273006013		Honey		490g	190
B354000A17205	831273006020		Antique Brown		490g	190



**45°**  
RIDING POSITION

**B17 Narrow**

L279 x W151 x H70 mm



**B17 NARROW DETAILS**

**ROBUST STEEL FRAME  
AND HARDWARE**



**THE CLASSIC B17 SHAPE BUT  
WITH A NARROWER PROFILE**

ARTICLE	UPC/EAN	MODEL	LEATHER TOP	METAL STRUCTURE	WEIGHT	PRICE (€)
B214000A07202	831273005511		Black		528g	150
B214000A07203	831273006402	<b>B17 Narrow</b>	Honey	Black Steel Rail	528g	150
B214000A07205	831273005528		Antique Brown		528g	150





**60°**  
RIDING POSITION

**B17**

L275 x W175 x H65 mm



**B17 Short**

L242 x W176 x H58 mm



**B17 DETAILS**

CLASSIC B17  
LEATHER PROFILE



DURABLE STEEL RIVETS  
AND FINISHINGS

ARTICLE	UPC/EAN	MODEL	LEATHER TOP	METAL STRUCTURE	WEIGHT	PRICE (€)
B211000A07202	831273005245	<b>B17</b>	Black	Black Steel	535g	150
B211000A07203	831273005702		Honey		535g	150
B211000A07205	831273006136		Antique Brown		535g	150
B211D00A07202	831273005252	<b>B17 Short</b>	Black	Black Steel	460g	150
B211D00A07203	831273005726		Honey		460g	150
B211D00A07205	831273006396		Antique Brown		460g	150



**60°**  
RIDING POSITION

**B17 Carved**

L 275 x W 175 x H 65 mm



**B17 Softened**

L275 x W175 x H65 mm



**B17 CARVED DETAILS**

CLASSIC B17  
LEATHER PROFILE

ERGONOMIC CUT-OUT  
FOR PRESSURE RELIEF

DURABLE STEEL RIVETS  
AND FINISHINGS



ARTICLE	UPC/EAN	MODEL	LEATHER TOP	METAL STRUCTURE	WEIGHT	PRICE (€)
B211ILOA07202	831273006105		Black		520g	150
B211ILOA17203	831273006327	<b>B17 Carved</b>	Honey	Chrome Steel	520g	150
B211ILOA17205	831273006334		Antique Brown		520g	150
B211PLOA07210	831273005894	<b>B17 Softened</b>	Dark Tan	Black Steel	530g	150



**60°**  
RIDING POSITION

**B17 Special**

L275 x W175 x H65 mm



**B17 Special Titanium**

L275 x W175 x H65 mm



**B17 SPECIAL TITANIUM DETAILS**

LIGHTWEIGHT, DURABLE AND  
VIBRATION-REDUCING TITANIUM FRAME



HAND-FINISHED, ULTRA-DURABLE  
PREMIUM COPPER RIVETS

HAND-CHAMFERED  
LEATHER DETAIL

ARTICLE	UPC/EAN	MODEL	LEATHER TOP	METAL STRUCTURE	WEIGHT	PRICE (€)
B211000A17202	831273005719	<b>B17 Special</b>	Black	Copper Steel Rail & Hand Hammered Copper Rivets	540g	190
B211000A17203	831273005269		Honey		540g	190
B211000A17205	831273006167		Antique Brown		540g	190
B211000A27202	831273005207	<b>B17 Special Titanium</b>	Black	Titanium Rail & Hand Hammered Copper Rivets	410g	260



**60°**  
RIDING POSITION

**Flyer**

L275 x W175 x H87 mm



**NEW COLORS**

**Flyer Short**

L242 x W176 x H86 mm



**FLYER DETAILS**

CLASSIC FLYER  
LEATHER PROFILE

STEEL COILS FOR ENHANCED  
RIDE COMFORT AND SHOCK ABSORPTION



DURABLE STEEL FRAME  
AND CONSTRUCTION

ARTICLE	UPC/EAN	NEW	MODEL	LEATHER TOP	METAL STRUCTURE	WEIGHT	PRICE (€)
B396H00A07202	831273005160			Black		860g	160
B396H00A07203	831273005177		<b>Flyer</b>	Honey	Black Steel	860g	160
B396H00A07205	831273006440			Antique Brown		860g	160
B396D00A07202	831273005184			Black		800g	160
B396D00A07203	831273005191	<b>NEW</b>	<b>Flyer Short</b>	Honey	Black Steel	800g	160
B396D00A07205	831273006457	<b>NEW</b>		Antique Brown		800g	160



**60°**  
RIDING POSITION

**Flyer Carved**

L275 x W175 x H87 mm



**Flyer Softened**

L275 x W175 x H87 mm



FLYER SOFTENED DETAILS

SUSPENDED FRAME FOR IMPROVED COMFORT AND SHOCK ABSORPTION



PRE-CONDITIONED,  
SOFTER, LEATHER TOP

ARTICLE	UPC/EAN	MODEL	LEATHER TOP	METAL STRUCTURE	WEIGHT	PRICE (€)
B396HILA07202	190445008706		Black		860g	160
B396HILA07203	190445008690	<b>Flyer Carved</b>	Honey	Black Steel Rail	860g	160
B396HILA07205	190445020258		Antique Brown		860g	160
B396HPLA07210	831273005917	<b>Flyer Softened</b>	Dark Tan	Black Steel	860g	160



**60°**  
RIDING POSITION

**B67**

L260 x W205 x H73 mm



**B67 Short**

L240 x W205 x H85 mm



**B67 SHORT DETAILS**

WIDER REAR PROFILE FOR GREATER STABILITY AND UPRIGHT COMFORT



ARTICLE	UPC/EAN	MODEL	LEATHER TOP	METAL STRUCTURE	WEIGHT	PRICE (€)
B427HSA07202	831273005061	<b>B67</b>	Black	Black and Chrome Steel	850g	160
B427HSA07203	831273005108		Honey		850g	160
B427HSA07205	831273005085		Antique Brown		850g	160
B427DSA07202	831273005078	<b>B67 Short</b>	Black	Black and Chrome Steel	810g	160
B427DSA07203	831273005115		Honey		810g	160
B427DSA07205	831273005092		Antique Brown		810g	160



**60°**  
RIDING POSITION

**B66**

L260 x W205 x H101 mm



**B66 Short**

L240 x W205 x H102 mm



**B66 DETAILS**

DOUBLE SPRUNG FRAME FOR IMPROVED  
COMFORT AND SHOCK ABSORPTION



ARTICLE	UPC/EAN	MODEL	LEATHER TOP	METAL STRUCTURE	WEIGHT	PRICE (€)
B281HSOA07202	831273005009	<b>B66</b>	Black	Black and Chrome Steel with Clamp	1050g	180
B281HSOA07203	831273005047		Honey		1050g	180
B281HSOA07205	831273005023		Antique Brown		1050g	180
B281DSOA07202	831273005016	<b>B66 Short</b>	Black	Black and Chrome Steel with Clamp	1020g	180
B281DSOA07203	831273005054		Honey		1020g	180
B281DSOA07205	831273005030		Antique Brown		1020g	180



**90°**  
RIDING POSITION

**B33**

L318 x W235 x H110 mm



**B33 DETAILS**



TRIPLE COIL  
SUSPENDED FRAME

ARTICLE	UPC/EAN	MODEL	LEATHER TOP	METAL STRUCTURE	WEIGHT	PRICE (€)
B256S00A07202	831273005146	<b>B33</b>	Black	Chrome Steel Rail with Clamp	1600g	230
B256S00A07203	831273005153		Honey		1600g	230





**90°**  
RIDING POSITION

**NEW**

**B68**  
L260 x W205 x H52 mm



#### B68 DETAILS

ITS UN-SPRUNG METAL STRUCTURE,  
COMBINED WITH A STANDARD RAIL (7X7),  
ALLOWS THE RIDER TO MOUNT THIS SADDLE  
ON ALL MICRO-ADJUSTMENT SEATPOSTS  
AVAILABLE ON THE MARKET



ARTICLE	UPC/EAN	NEW	MODEL	LEATHER TOP	METAL STRUCTURE	WEIGHT	PRICE (€)
B282HSOA07202	190445015780	<b>NEW</b>		Black		540g	160
B282HSOA07205	190445020784	<b>NEW</b>	<b>B68</b>	Honey	Un-Sprung Metal Structure, Standard Rail (7x7)	540g	160
B282HSOA07203	831273005825	<b>NEW</b>		Antique Brown		540g	160



**90°**  
RIDING POSITION

**NEW**

**B72**  
L260 x W205 x H56 mm



**B72 DETAILS**



FEATURING A DOUBLE-COIL SPRUNG RAIL, THE B72 HAS BEEN DESIGNED FOR AN UPRIGHT RIDING POSITION, BEING THE BEST CHOICE BOTH FOR ROAD TOURER AND FIRST MTB RIDERS IN THE NEXT DECADES

ARTICLE	UPC/EAN	NEW	MODEL	LEATHER TOP	METAL STRUCTURE	WEIGHT	PRICE (€)
B391000A07202	831273005498	<b>NEW</b>	<b>B72</b>	Black	Double-Coil Sprung Rail	720g	180
B391000A07205	831273005481	<b>NEW</b>		Antique Brown		720g	180

# BAR TAPE & GRIPS

## FIT FOR LEATHER SADDLES

Per i nostri nastri manubrio usiamo cuoio e microfibra, dando ai ciclisti lo stesso comfort, affidabilità e durata delle selle in cuoio. Le nostre manopole sono realizzate con cura e con cuoio conciato al vegetale, sono il complemento perfetto delle nostre selle e delle nostre borse da bici.

### Slender Leather Grips

130/130, 130/100 or 100/100 mm



NATURAL MATERIAL



COMFORTABLE TO THE TOUCH



MADE TO LAST



130/130 mm



130/100 mm

100/100 mm

ARTICLE	UPC/EAN	MODEL	COLOR	DESCRIPTION	PRICE (€)
BLG4LLOA17202	8021890580757		Black		90
BLG4LLOA17203	8021890580764		Honey	130/130 mm	90
BLG4LLOA17205	8021890580771		Antique Brown	Vegetable Tanned Leather	90
BLG4LLOA17210	8021890580788	<b>Slender Leather Grips</b>	Dark Tan		90
BLG4LSOA17202	8021890580795		Black	130/100 mm	90
BLG4LSOA17203	8021890580801		Honey	Vegetable Tanned Leather	90
BLG4SSOA17202	8021890580870		Black	100/100 mm	90
BLG4SSOA17203	8021890580887		Honey	Vegetable Tanned Leather	90

**Leather Bar Tape**

Perforated Leather Tape



NATURAL MATERIAL



NATURALLY BREATHABLE



MADE TO LAST



**Microfiber Bar Tape**

3mm Comfort Padding



LIGHTWEIGHT



FOR GRIP AND CONTROL



MADE TO LAST



ARTICLE	UPC/EAN	MODEL	COLOR	DESCRIPTION	PRICE (€)
BT02000A17202	8021890581013	<b>Leather Bar Tape</b>	Black	Perforated Leather Tape	70
BT02000A17203	8021890581020		Honey		70
BT02000A17205	8021890581037		Antique Brown		70
BT03000A15202	8021890569820	<b>Microfiber Bar Tape</b>	Black	3mm Comfort Padding	35
BT03000A15203	8021890569837		Honey		35
BT03000A15205	8021890569844		Antique Brown		35

# BIKE BAGS

Che sia per il turismo o per il commuting, per brevi distanze o quelle senza una meta prefissata - quando un ciclista è in viaggio può fare affidamento su tre cose: su sé stesso, sulla sua bici e sulla sua attrezzatura. E quando si parla di attrezzatura Brooks realizza borse resistenti, con uno stile unico e con materiali di alta qualità.

## Challenge Saddle Bag 1,2L

L260 x W65 x H110 mm



EXCEPTIONAL  
CRAFTSMANSHIP



UNIQUE PREMIUM  
DETAILS



GREATER STABILITY



ARTICLE	UPC/EAN	MODEL	COLOR	DESCRIPTION	PRICE (€)
B743700A17202	8021890581396		Black		115
B743700A17203	8021890581402	<b>Challenge Saddle Bag 1,2L</b>	Honey	Vegetable	115
B743700A17205	8021890581419		Antique Brown	Tanned Leather	115
B743700A17210	8021890581426		Dark Tan		115

# BICYCLE ACCESSORIES

La differenza la fanno i dettagli e anche i nostri piccoli accessori sono costruiti con alti standard qualitativi migliorando e completando l'esperienza in bici.

**Femto**  
Front & Rear Lights



**MT21**  
Multi-Tool



**Trousers Straps**



**Sandwich Seat Adapter**

**NEW**



**Leather Hub Shiner**

**NEW**



ARTICLE	UPC/EAN	NEW	MODEL	COLOR	DESCRIPTION	PRICE (€)
BLLF000A12001	8021890580955		<b>Femto Front Light</b>	Copper	Front Light Copper	25
BLLR000A12001	8021890580962		<b>Femto Rear Light</b>	Copper	Rear Light Copper	25
BMT2100A17202	8021890570901		<b>Multitool MT21</b>	Black	Multi-Tool & Leather Sleeve	68
BTR1000A17202	8021890570918			Black		30
BTR1000A17203	8021890570925		<b>Trousers Straps</b>	Honey	Leather Strap	30
BTR1000A17205	8021890570932			A. Brown		30
BSSA000A0A008	8021890595126	<b>NEW</b>	<b>Sandwich Seat Adapter</b>	-	CNC alluminium worked- Hard anodized finish	45
BHS0001A07202	8021890592538	<b>NEW</b>		Black		22
BHS0001A07203	8021890592545	<b>NEW</b>	<b>Leather Hub Shiner</b>	Honey	Scrab of Leather bike bag and slender, vegetable tanned leather + metal keychain	22
BHS0001A07205	8021890592552	<b>NEW</b>		A. Brown		22

# CARE & MAINTENANCE

I prodotti Brooks invecchieranno meravigliosamente garantendo al ciclista anni di uso ininterrotto.

Tuttavia, richiedono un po' di attenzione, per questo è presente una sezione dedicata alla cura dei prodotti, così da permettere che la tua sella e le tue borse possano durare ancora più a lungo.



Leather Saddle  
Care Kit Dispenser  
(14 pcs)

ARTICLE	UPC/EAN	MODEL	DESCRIPTION	PRICE (€)
AMA0100A00	190445017241	Leather Saddle Care Kit Dispenser	Each box: 1 Cloth, 1 Proofide 30ml, 1 Spanner	18,00 each



**Leather Saddle  
Care Kit**



**Bike Bag  
Repair kit**



**Single  
Rain Cover**



**Proofide Single**  
30ml jar - 50ml jar

ARTICLE	UPC/EAN	MODEL	DESCRIPTION	PRICE (€)
AMA0100000	8021890542724	<b>Leather Saddle Care Kit</b>	1 Cloth, 1 Proofide 30ml, 1 Spanner	18,00
AMA0500A00	8021890569783	<b>Bike Bag Repair Kit</b>	Water Based Glue 20ml / PU Glue 15ml / Zip Wax 20ml / 2 Adhesive Patches / 3 Small Spatulas	50,00
BMK0047A00000	8021890570987	<b>Dispenser for Rain Covers S/M/L</b>	Containing 10 Medium Saddle Covers	-
BMK0048A00000	8021890570994	<b>Dispenser for Rain Covers XL</b>	Containing 10 Large Saddle Covers	-
BRCM000A18102	8021890571014	<b>Single Rain Covers S/M/L (Black)</b>	S/M/L size	15,00
BRCL000A18102	8021890571007	<b>Single Rain Covers XL (Black)</b>	Only for B73 - B190 - B135 - B33	15,00
AMA0400A1S	8021890570970	<b>Proofide Single</b>	Wax 30ml jar	14,00
AMA0400A1L	190445017289		Wax 50ml jar	18,00



# MATCHING OPPORTUNITIES

FOR LEATHER RANGE

Black



Honey



Antique  
Brown



Dark Tan



## B17\*

L275 x W175 x H65 mm/520g

## B17 Softened

L275 x W175 x H65 mm/530g

\*matching option available also  
for the other saddles models

## Slender Leather Grips

130/130, 130/100 or 100/100 mm

## Leather Bar Tape

Perforated Leather Tape



**Microfiber Bar Tape**  
3 mm Comfort Padding

**Trousers Strap**

**Challenge Saddle Bag 1,2L**  
L210 x W70 x H110 mm



**Scape  
& Bike  
bags**

# SCAPE BAGS

Attacco: sistema KCLICKFix® in alluminio.

Cinghia interna in velcro per una chiusura sicura della parte avvolta.

Leggero gancio in alluminio.

Materiali impermeabili resistenti a una colonna d'acqua di oltre 50.000 mm, privi di PVC e PFC.

Fasce velcro in Hypalon per fissare le estremità della fettuccia.

Tasca anteriore a patta, per una protezione extra con tiretto a un dito per un utilizzo facile anche in movimento.

Fettucce in nylon, resistenti e durevoli.

Cinghia laterale con passanti, per un impiego modulare e con dettagli riflettenti.

Logo riflettente.



## Tutto il necessario per chi ama le avventure in bicicletta

Che si tratti di una borsa per un viaggio breve o di qualcosa di più capiente per una lunga avventura su terreni impegnativi, la gamma di borse Brooks England Scape Travel Bag ti offre tutta la versatilità di cui hai bisogno. Così non dovrai fare altro che concentrarti sull'avventura che ti aspetta.

Ogni elemento di questo sistema modulare e adattabile è realizzato secondo gli eccezionali standard di lavorazione di Brooks England. Queste borse sono pensate per il gravel, i trail e la libertà e l'evasione del bikepacking, e utilizzano materiali in grado di offrire i massimi livelli di impermeabilità e resistenza. I sistemi di fissaggio innovativi permettono di assicurare le borse alla bicicletta in diverse posizioni e di combinarle tra loro per ottenere maggiore capacità di carico ogni volta che ne hai bisogno.

# Range Overview

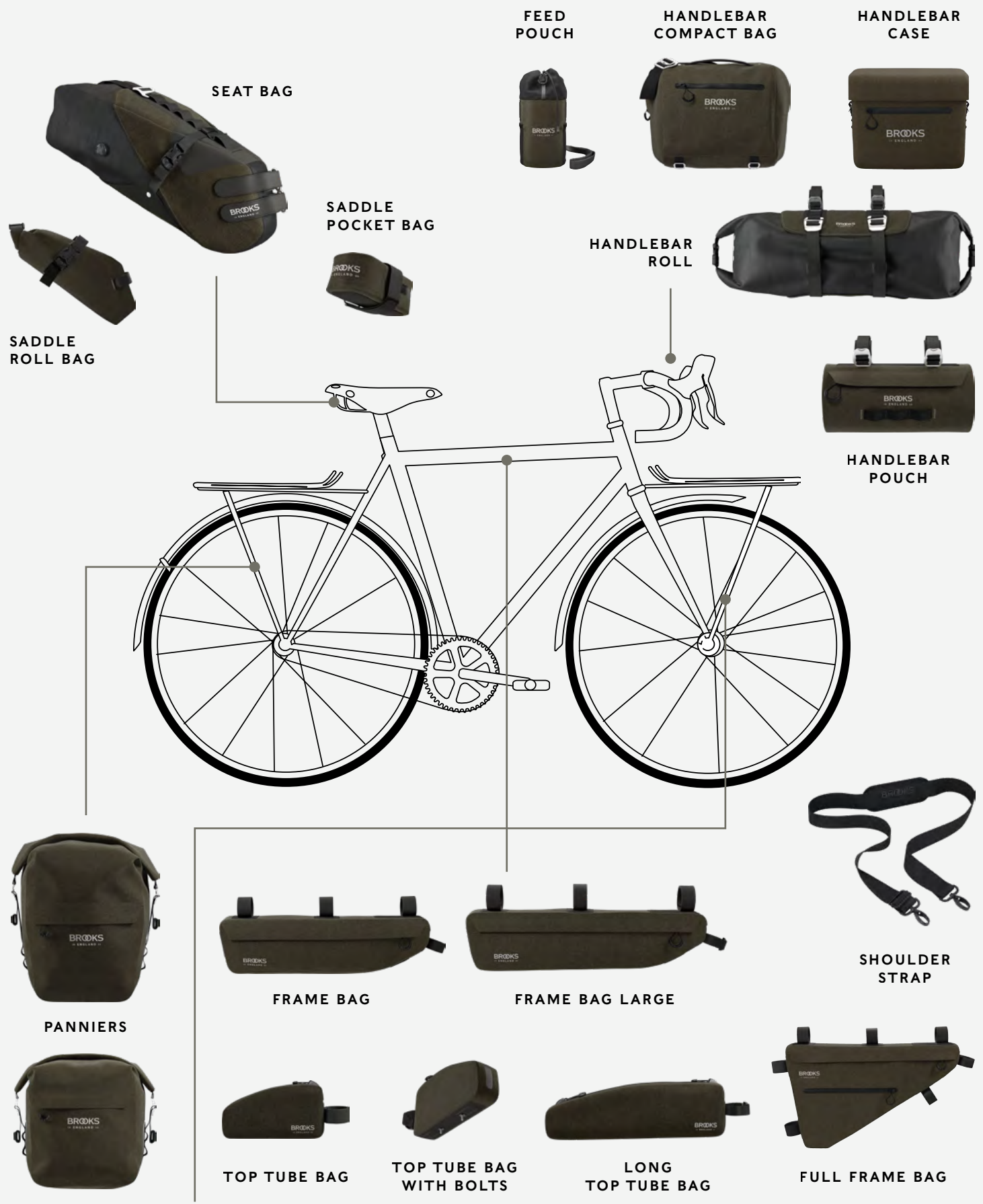

# Key Features

## PREMIUM HARDWARE



ALUMINIUM  
LIGHTWEIGHT  
RELIABLE

## RELIABLE SOFT DETAILS



PREMIUM HYPALON  
STRAPS WATERPROOF &  
WELDED FINISHING  
FLEX RESISTANT

## RELIABLE ATTACHMENTS



ALUMINIUM KLICKFIX SYSTEM  
QUICK RELEASE  
ADAPTABLE  
LIGHTWEIGHT

## WIDE VELCRO STRAPS



DETACHABLE  
VERSATILE  
REFINED (VELCRO  
BONDED WITH HYPALON)

## CLEVER SOLUTIONS



STRAP FIXING  
MULTIPLE ATTACHMENT  
OPTIONS

## DAISY CHAINS



MULTIPLE LOOPS  
FUNCTIONAL  
VERSATILE

## PROVEN ZIP OPENINGS

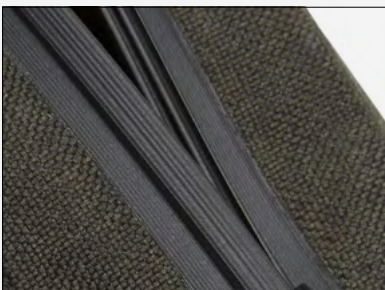

WATER-REPELLENT  
EASY TO CLEAN  
ONE-HAND OPENING

## COMPARTMENTS

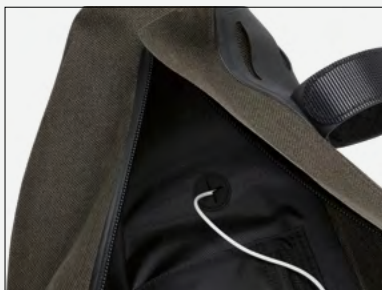

SPACE OPTIMIZATION  
EASY ACCESS

## REFLECTIVE DETAILS



CLEVER USE OF REFLECTIVE  
VISIBLE LOGO  
(EMBOSSED PRINT)





## HANDLEBAR BAGS

# Scape Handlebar Case

A classic bike handlebar bag for every cycling journey

La Scape Handlebar Case è una borsa essenziale per un lungo viaggio in bici. Resistente all'acqua, capiente, pratica e facile da aprire grazie ad un sistema di chiusura magnetico che permette di accederci in ogni momento senza doversi fermare. Oltre al vano principale, caratterizzato da due tasche con zip e due custodie in rete, è presente una tasca esterna per riporre gli oggetti più piccoli. Una volta scesi dalla bici si può comodamente usare come borsa grazie al sistema Klick Fix® che permette di staccarla e attaccarla alla bici rapidamente.

### Scape Handlebar Case 8L

W260 x H225 x D170 mm

Weight: 650g



WATERPROOF



LASTING  
PERFORMANCE



PRACTICAL  
FUNCTIONALITY



ADAPTABLE &  
VERSATILE



### DETAILS



ARTICLE	UPC/EAN	MODEL	COLOR	DESCRIPTION	PRICE (€)
BHB05PLA00401	8021890566775	Handlebar Case 8L	Mud Green	Polyester 600D Two Tone with Hypalon details	140

# Scape Feed Pouch

A small accessory pouch for bikepacking and cycling adventures

La Scape Feed Pouch è essenziale per ogni tipo di ride, di piccole dimensioni è comoda da utilizzare mentre si è in movimento. Può contenere una bottiglia da un litro, una fotocamera o altri oggetti di piccole dimensioni, presenta un'ulteriore tasca esterna per tenere a portata di mano oggetti come crema solare o snack che possono sempre essere utili durante il percorso. La Scape Feed Pouch si può fissare su entrambi i lati del manubrio utilizzando la doppia fascia di velcro e una cinghia regolabile che aiuta a renderla più stabile durante il percorso.

## Scape Feed Pouch 1,2L

W100 x H160 x D100 mm

Weight 100g



WATER-RESISTANT



LASTING PERFORMANCE



PRACTICAL FUNCTIONALITY



## DETAILS



ARTICLE	UPC/EAN	MODEL	COLOR	DESCRIPTION	PRICE (€)
BHB04PLA00401	8021890566768	Feed Pouch 1,2L	Mud Green	Polyester 600D Two Tone with Hypalon details	50
BHB04PLA00000	8021890574299		Black		50

# Scape Handlebar Pouch

A Handlebar Pouch for Much-Needed Items

La Scape Handlebar Pouch è una piccola borsa da manubrio impermeabile, comoda per riporre gli oggetti di maggiore necessità. Utile da utilizzare sia per il cicloturismo di lunga distanza sia per il commuting. Facile da montare per mezzo di due fibbie in alluminio e una fascia che si aggancia al tubo di sterzo impedisce alla borsa di oscillare. La Scape Handlebar Pouch può essere assemblata ad altre borse della serie Scape, ad esempio sopra la chiusura della Scape Handlebar Roll.

## Handlebar Pouch 3L

W250 x H120 x D120 mm

Weight 140g



WATERPROOF



LASTING PERFORMANCE



PRACTICAL FUNCTIONALITY



ADAPTABLE & VERSATILE



## DETAILS



ARTICLE	UPC/EAN	MODEL	COLOR	DESCRIPTION	PRICE (€)
BHB01PLA00401	190445017661	Handlebar Pouch 3L	Mud Green	Polyester 600D Two Tone with Hypalon details	70
BHB01PLA00000	8021890567239		Black		70

# Scape Handlebar Compact Bag

A Handlebar Bag for Commuting and Travelling

Scape Handlebar Compact Bag è una borsa removibile realizzata con materiali leggeri e impermeabili.

È utilizzabile sia come borsa per lunghi percorsi sia per il commuting. Al suo interno presenta dei divisori in neoprene e uno scompartimento imbottito per un computer da 13", una tasca con zip e due tasche elastiche in rete. Si aggancia alla bici con il sistema di aggancio Klick Fix®. Inoltre, quando si scende dalla bici, si può comodamente usare come borsa grazie alla tracolla.

## Handlebar Compact Bag 10L

W340 x H250 x D140 mm

Weight 475g



WATER-RESISTANT



LASTING  
PERFORMANCE



PRACTICAL  
FUNCTIONALITY



ADAPTABLE &  
VERSATILE



Non utilizzare con manubri in carbonio.

## DETAILS



ARTICLE	UPC/EAN	MODEL	COLOR	DESCRIPTION	PRICE (€)
BHB02PLA00401	190445017753	Handlebar Compact Bag 10L	Mud Green	Polyester 600D Two Tone with Hypalon details	120

## HANDLEBAR BAGS

# Scape Handlebar Roll

A Handlebar Roll, Built for Adventure

Progettata per l'avventura, la Scape Handlebar Roll è una borsa da bikepacking composta da due elementi: un supporto fisso e una drybag removibile. La dry bag, 100% impermeabile (certificazione IPX4) è dotata di uno scompartimento interno per organizzare al meglio il contenuto.

Facile da montare su tutte le tipologie di manubri, drop bar e flat bar, garantisce sempre al ciclista un buon appoggio sul manubrio. Il supporto della borsa si fissa con due fasce in alluminio e una fascia che si aggancia al tubo di sterzo impedisce alla borsa di oscillare. Il supporto fisso è dotato di una serie di asole per fissare altre borse.

### Handlebar Roll 9-11L

W350-400 x H160 x D160 mm

Weight 670g



WATERPROOF (IPX4)



LASTING  
PERFORMANCE



PRACTICAL  
FUNCTIONALITY



## DETAILS



ARTICLE	UPC/EAN	MODEL	COLOR	DESCRIPTION	PRICE (€)
BHB03PLA00401	190445017678	Handlebar Roll 9-11L	Mud Green	Polyester 600D Two Tone	140
BHB03PLA00000	802189057428		Black	with Hypalon details	140

# Scape Seat Bag

A Seat Bag Made for Gravel and Adventure Cycling

Progettata per il gravel e per il ciclismo d'avventura, la Scape Seat Bag è una borsa da bikepacking composta da due elementi: un supporto e una drybag removibile e impermeabile (certificazione IPX4).

Il supporto è realizzato con materiali resistenti per garantire sicurezza e durata, la sua base funge da parafango proteggendo la parte interna della borsa dalla ruota posteriore.

La drybag può comprimersi riducendo lo spazio interno grazie a una valvola d'aria.

La chiusura a roll top permette di ridurre le sue dimensioni quando la capienza necessaria è minore.

Nella parte superiore è presente una struttura con asole per assemblare altre borse della linea Scape ed è inoltre presente un supporto per fissare una luce posteriore.

## Seat Bag 8-10L

W400-600 x H180 x D140 mm

Weight 500g



WATERPROOF (IPX4)



LASTING  
PERFORMANCE



PRACTICAL  
FUNCTIONALITY



## DETAILS



ARTICLE	UPC/EAN	MODEL	COLOR	DESCRIPTION	PRICE (€)
BSB03PLA00401	190445017739	Seat Bag 8-10L	Mud Green	Polyester 600D Two Tone	140
BSB03PLA00000	8021890574305		Black	with Hypalon details	140

## SADDLE BAGS

# Scape Saddle Pocket Bag

Modular Saddle Bag That Attaches in Multiple Ways

La Scape Saddle Pocket Bag è una piccola e pratica borsa impermeabile, è perfetta per il bikepacking o il gravel e si può agganciare in più modi. È presente una cerniera con autolock lungo tutto il perimetro della borsa, che permette la massima apertura possibile, mentre porzioni in hypalon su ambo i lati ne garantiscono la protezione. È utilizzabile come classica borsetta sottosella oppure come versatile borsa da assemblare ad altre borse.

### Saddle Pocket Bag 0,7L

W150 x H55 x D80 mm

Weight 70g



WATERPROOF



LASTING  
PERFORMANCE



PRACTICAL  
FUNCTIONALITY



ADAPTABLE &  
VERSATILE



## DETAILS



ARTICLE	UPC/EAN	MODEL	COLOR	DESCRIPTION	PRICE (€)
BSB01PLA00401	190445017715	Saddle Pocket Bag 0,7L	Mud Green	Polyester 600D Two Tone with Hypalon details	50
BSB01PLA00000	8021890567260		Black		50

# Scape Saddle Roll Bag

A Saddle Bag Made for Medium Loads

Realizzata per il bikepacking, per il gravel e per le avventure in bicicletta, la Scape Saddle Roll Bag è una borsa termosaldata e realizzata con materiali resistenti (certificazione IPX4). La chiusura a roll top consente sia un accesso facile sia l'ottimizzazione dello spazio; infatti, si rimpicciolisce arrotolandola su se stessa, quando è necessaria una capienza inferiore.

## Saddle Roll Bag 1L

W320 x H100 x D100 mm

Weight 75g



WATERPROOF (IPX4)



LASTING  
PERFORMANCE



PRACTICAL  
FUNCTIONALITY



## DETAILS



ARTICLE	UPC/EAN	MODEL	COLOR	DESCRIPTION	PRICE (€)
BSB02PLA00401	190445017722	<b>Saddle Roll Bag 1L</b>	Mud Green	Polyester 600D Two Tone with Hypalon details	50



## PANNIERS

# Scape Small Pannier

A perfect pannier for the front or rear rack

Scape Small Pannier è una borsa al 100% resistente all'acqua con una chiusura a roll top, da collocare sul portapacchi anteriore o posteriore (certificazione IPX4). Pensata per il cicloturismo, realizzata con materiali resistenti, ha una tasca frontale per permettere di organizzare e gestire al meglio gli oggetti da portare con sé. Grazie al supporto laterale, la borsa offre anche una speciale funzionalità modulare per attaccare altre borse della serie Scape. È provvista dell'attacco Klick Fix® in alluminio, per un fissaggio facile sulla maggior parte dei portapacchi in commercio.

### Small Pannier 10-13L

W260 x H300-470 x D150 mm

Weight 630g



WATERPROOF (IPX4)



LASTING  
PERFORMANCE



PRACTICAL  
FUNCTIONALITY



## DETAILS



ARTICLE	UPC/EAN	MODEL	COLOR	DESCRIPTION	PRICE (€)
BPA01PLAOS401	190445017708	Small Pannier 10-13L	Mud Green	Polyester 600D Two Tone with Hypalon details	120
BPA01PLAOS000	8021890567253		Black		120

# Scape Large Pannier

A modern and functional rear pannier

Scape Large Pannier è una borsa disegnata per il portapacchi posteriore, 100% resistente all'acqua, termosaldata e con una chiusura a roll top (certificazione IPX4). Questa borsa per il cicloturismo è realizzata con materiali resistenti e ha una tasca frontale per permettere di organizzare e gestire al meglio gli oggetti da portare con sé. Il supporto laterale della borsa permette di agganciare altre borse della serie Scape, oppure una luce posteriore. È inoltre provvista di un attacco Klik Fix® in alluminio, per adattarsi alla maggior parte dei portapacchi.

## Large Pannier 18-22L

W320 x H400-600 x D160 mm

Weight 760g



WATERPROOF (IPX4)



LASTING  
PERFORMANCE



PRACTICAL  
FUNCTIONALITY



## DETAILS



ARTICLE	UPC/EAN	MODEL	COLOR	DESCRIPTION	PRICE (€)
BPA01PLA0L401	190445017685	Large Pannier 18-22L	Mud Green	Polyester 600D Two Tone with Hypalon details	125
BPA01PLA0L000	8021890567246		Black		125

# Scape Full Frame

A full frame bag for adventure cycling and bikepacking

La Scape Full Frame Bag è una borsa a telaio impermeabile disegnata per il bikepacking, il gravel e tutte le altre avventure in bicicletta. Presenta uno scompartimento principale spazioso chiuso da una zip che permette un accesso facile e veloce. La piccola tasca impermeabile utilizza un'innovativa zip KCC ed è perfetta per contenere piccoli oggetti. È inoltre presente un pratico passacavi in TPU per collegare un powerbank. La Scape Full Frame Bag si fissa in sicurezza grazie a sette strap in velcro con Hypalon.

## Scape Full Frame Bag 5,5L

W480 x H290 x D60 mm

Weight: 390g



WATERPROOF



LASTING PERFORMANCE



PRACTICAL FUNCTIONALITY



## DETAILS



ARTICLE	UPC/EAN	MODEL	COLOR	DESCRIPTION	PRICE (€)
BFB02PLA00401	8021890566751	Full Frame 5,5L	Mud Green	Polyester 600D Two Tone	120
BFB02PLA00000	8021890574275		Black	with Hypalon details	120

# Scape Frame Bag

A Frame Bag with an Easy Access On-The-Go

Capace di adattarsi alla maggior parte dei telai di dimensioni standard, la Scape Frame Bag è una half-frame bag, impermeabile, adatta per il bikepacking, il gravel e altre avventure in bicicletta.

Lo scompartimento principale presenta un'organizzazione interna e un pratico passacavi in TPU.

Mentre sul lato opposto è presente una tasca con zip KCC, per contenere i piccoli oggetti.

La borsa si fissa in sicurezza grazie a cinque strap in velcro con Hypalon.

## Frame Bag 3L

W460 x H120 x D60 mm

Weight 215g



WATERPROOF



LASTING PERFORMANCE



PRACTICAL FUNCTIONALITY



## DETAILS



ARTICLE	UPC/EAN	MODEL	COLOR	DESCRIPTION	PRICE (€)
BFB01PLA00401	190445017654	<b>Frame Bag 3L</b>	Mud Green	Polyester 600D Two Tone	95
BFB01PLA00000	8021890567222		Black	with Hypalon details	95

## FRAME BAGS

# Scape Frame Bag Large

A spacious frame bag for bike adventures of all sizes

Porta con te tutto l'occorrente per le tue fughe con la Scape Large Frame Bag. Progettata per trasportare l'indispensabile per le tue avventure, la nostra versatile borsa da bikepacking è dotata di una struttura saldata per una massima protezione dalle intemperie. Le due tasche laterali, una con cerniera a tutta lunghezza per accedere allo scomparto principale e l'altra con una cerniera impermeabile KCC più piccola, si combinano con una tasca interna organizer per offrire la massima praticità mentre sei in viaggio. Fissabile al telaio tramite cinghie in velcro Hypalon, la Scape Large Frame Bag si adatta alla maggior parte dei modelli di bicicletta standard ed è sufficientemente spaziosa per adattarsi a qualsiasi viaggio.

### Frame Bag Large 3,5L

W500 x H120 x D46 mm

Weight 200g



WATERPROOF



LASTING  
PERFORMANCE



PRACTICAL  
FUNCTIONALITY



## DETAILS



ARTICLE	UPC/EAN	MODEL	COLOR	DESCRIPTION	PRICE (€)
BFB03PLA00401	8021890573902	Frame Bag Large 3,5L	Mud Green	Polyester 600D Two Tone with Hypalon details	100
BFB03PLA00000	8021890576378		Black		100

# Scape Long Top Tube Bag

A roomy top tube bag for easy access to essentials

Le grandi avventure richiedono soluzioni pratiche, come la Scape Long Top Tube Bag – la borsa perfetta per trasportare gli oggetti di valore e proteggerli dalle intemperie in qualsiasi condizione di utilizzo. Porta con te snack per le tue uscite gravel o una mappa per esplorare fuori dai sentieri battuti: grazie alla maggiore capacità della nostra Scape Long Top Tube Bag avrai sempre a portata di mano tutto l'essenziale per vivere al meglio ogni avventura. La cerniera a doppio lato è impermeabile e facile da usare, anche con una mano. Fissabile in modo semplice e sicuro tramite cinghie in Hypalon, con Scape potrai sfruttare al meglio tutto lo spazio disponibile.

## Long Top Tube Bag 1,5L

W370 x H110 x D40 mm

Weight 150g



WATERPROOF



LASTING  
PERFORMANCE



PRACTICAL  
FUNCTIONALITY



## DETAILS



ARTICLE	UPC/EAN	MODEL	COLOR	DESCRIPTION	PRICE (€)
BTTO2PLA00401	8021890573926	Long Top Tube Bag 1,5L	Mud Green	Polyester 600D Two Tone with Hypalon details	65
BTTO2PLA00000	8021890576385		Black		65

# Scape Top Tube Bag

A Convenient Accessory Bag for Oft-Needed Items

La Scape Top Tube Bag è una comoda borsa da bike packing con struttura termosaldata con una cerniera impermeabile per mantenere gli accessori asciutti e al sicuro. Completata da dettagli funzionali, come il logo esterno riflettente e il pratico foro passacavi realizzato in TPU.

Si aggancia facilmente con delle fasce velcro in Hypalon.

## Top Tube Bag 0,9L

W210 x H110 x D40 mm

Weight 100g



WATERPROOF



LASTING PERFORMANCE



PRACTICAL FUNCTIONALITY



## Top Tube Bag e with bolts 0,9L

W210 x H110 x D40 mm

Weight 100g



## DETAILS



WITH BOLTS

ARTICLE	UPC/EAN	MODEL	COLOR	DESCRIPTION	PRICE (€)
BTT01PLA00401	190445017746	<b>Top Tube Bag 0,9L</b>	Mud Green	Polyester 600D Two Tone with Hypalon details	55
BTT01PLA00000	8021890567277		Black		55
BTT03PLA00401	8021890573933	<b>Top Tube Bag 0,9L with bolts</b>	Mud Green	Polyester 600D Two Tone with Hypalon details	65
BTT03PLA00000	8021890576392		Black		65

# SCAPE ACCESSORIES

**Scape Bike Bag  
Pannier Shoulder Strap**  
For Panniers and Pouch



ARTICLE	UPC/EAN	MODEL	COLOR	DESCRIPTION	PRICE (€)
ABB01PLA00000	190445017623	<b>Scape Bike Bag Pannier Shoulder Strap</b>	Black	Nylon and Hypalon	25





**Backpack**

**&**

**Shoulder**

**bags**

# PICKWICK



**Un elegante zaino roll-top fatto a mano, disponibile in una varietà di stili e materiali.**

Da sempre uno dei nostri zaini più amati, il Pickwick è caratterizzato da una semplice chiusura arrotolabile per la massima capienza ed è pensato per adattarsi al tuo modo di affrontare la giornata.

È disponibile in una varietà di materiali e stili diversi: a partire dalla pelle conciata al vegetale, che si patina splendidamente con il passare del tempo, fino ad arrivare alla tela di cotone ultra resistente e molto altro ancora. Massima capienza con il minimo ingombro: questo è Pickwick.

**Pickwick Cotton Canvas 12L**

L260 x W120 x H410/470 mm



EXPANDABLE  
CAPACITY



KEEPS BELONGINGS  
SAFE & SECURE



EASILY ADJUSTABLE



UNIQUE PREMIUM  
DETAILS



PADDED 13" OR 15"  
LAPTOP COMPARTMENT



**NEW COLOR**

**NEW COLOR**

**NEW COLOR**

DETAILS



ARTICLE	UPC/EAN	NEW	MODEL	COLOR	DESCRIPTION	PRICE (€)
BB02200A07200	190445007198		<b>Pickwick Cotton Canvas 12L</b>	Total Black	Water Resistant Cotton Canvas with Leather Details, Roll Top Closure, 13" Laptop Sleeve	220
BB02200A07266	190445007129			Grey/Honey		220
BB02200A07232	8021890581655			Sage Green/Honey		220
BB02200A07267	190445007112	<b>NEW</b>		Dark Blue/Black		220
BB02200A07249	190445007174	<b>NEW</b>		Goose Beak/Maroon		220
BB02200A07282	190445016015	<b>NEW</b>		Forest		220

## Pickwick Cotton Canvas 26L

L310 x W150 x H480/550 mm



EXPANDABLE  
CAPACITY



KEEPS BELONGINGS  
SAFE & SECURE



EASILY ADJUSTABLE



UNIQUE PREMIUM  
DETAILS



PADDED 13" OR 15"  
LAPTOP COMPARTMENT



**NEW COLOR**

**NEW COLOR**

### DETAILS



ARTICLE	UPC/EAN	NEW	MODEL	COLOR	DESCRIPTION	PRICE (€)
BB04300A07200	190445005804			Total Black		250
BB04300A07266	190445009765			Grey/Honey		250
BB04300A07282	190445016022		<b>Pickwick Cotton Canvas 26L</b>	Forest	Water Resistant Cotton Canvas with Leather Details, Roll Top Closure, 15" Laptop Sleeve	250
BB04300A07267	190445009741			Dark Blue/Black		250
BB04300A07249	190445009758	<b>NEW</b>		Goose Beak/Maroon		250
BB04300A07232	8021890581662	<b>NEW</b>		Sage Green/Honey		250

**Hoxton Basket 25L**

L380 x W260 x H260 mm



UNIQUE PREMIUM  
DETAILS



SPECIALLY SELECTED  
COMPONENTS



GREATER STABILITY



**Bricklane Roll-up Panniers 15L**

L350 x W120 x H360 mm



EXPANDABLE  
CAPACITY



UNIQUE PREMIUM  
DETAILS



GREATER STABILITY



**DETAILS**



ARTICLE	UPC/EAN	MODEL	COLOR	DESCRIPTION	PRICE (€)
BB00300A10003	8021890569790	<b>Hoxton Basket 25L</b>	Aluminium	Wire Basket with Wooden Base (included click fix mount)	190
BB00100A07266	190445008409	<b>Bricklane Roll-up Panniers 15L</b>	Grey/Honey	Water Resistant Cotton Canvas with Leather Details	200
BB00100A07232	8021890579706		Sage Green/Honey		200
BB00100A07249	8021890579713		Goosebeack/Maroon		200

# **Accessories & Spare parts**

# ACCESSORIES & SPARE PARTS

ARTICLE	MODEL	DESCRIPTION	PRICE (€)
<b>CAMBIUM ALL WEATHER</b>			
BYB0469A00000	<b>Rails</b>	C17 / C17C All Weather Bracket	15
BYB0470A00000	<b>Rails</b>	C15 / C15C All Weather Bracket	15
BYB0471A00000	<b>Rails</b>	C19 / C19C All Weather Bracket	15
BYB0472A00000	<b>Nose Pieces</b>	C15 / C17 All Weather Nose Kit Replacement	9
BYB0473A00000	<b>Nose Pieces</b>	C19 All Weather Nose Kit Replacement	9
BYB0475A00000	<b>Stud and Bolt</b>	C15 / C17 / C19 All Weather Square / B Boss + Screw	24
<b>CAMBIUM</b>			
BYB0373A00000	<b>Rails - Tubular Steel</b>	Cambium C15	33
BYB0366A00000	<b>Rails - Tubular Steel</b>	Cambium C17, C17 Carved	33
BYB0414A00000	<b>Rails - Tubular Steel</b>	Cambium C19	33
BYB0369A00000	<b>Rail Caps</b>	For all Cotton Cambium saddles	4,50
BYB0370A00000	<b>Nose Pieces</b>	Cambium C17/C17 Carved/C17 S/C17S Carved/C15/C15 Carved	17
BYB0415A00000	<b>Nose Pieces</b>	For C19 Cambium saddles	17
<b>CLAMPS (FOR LEATHER SADDLES)</b>			
BYB0101A00000	<b>Clamp 7/8" (22.2MM) for 1 Rail - Chrome</b>	For All Single Rail Models	23
BYB0105A00000	<b>Clamp 7/8" (22.2MM) for 2 Rail - Chrome</b>	For Double Rail Models (B66, B66's, B72, B73)	23
BYB0107A00000	<b>Clamp 7/8" (22.2MM) for 3 Rail - Chrome</b>	For Triple Rail Models (B33)	23
BMP0178A00000	<b>Boss Bar &amp; Nut Assy (Bolt-Zinc/Nuts-Chrome)</b>	All Clipped Saddles	6
<b>SPRINGS (LEATHER SADDLES)</b>			
BYB0224A00000	<b>Right Hand Stranded Coil - Chrome</b>	B33	13,50
BYB0350A00000	<b>Left Hand Stranded Coil - Chrome</b>	B33	13,50
BYB0227A00000	<b>Right Hand Coil - Chrome</b>	B66, B66 's', B73, B67, Champion, Champion'S	9
BYB0236A00000	<b>Left Hand Coil - Chrome</b>	B66, B66 's', B73, B67, Champion, Champion'S	9
BYB0250A00000	<b>Right Hand Coil - Black</b>	B67, B67 's', Flyer, Flyer 's', Flyer Special, Flyer Special 's', Conquest, Countess, B135, B190	9
BYB0253A00000	<b>Left Hand Coil - Black</b>	B67, B67 S , Flyer, Flyer 's', Flyer Special, Flyer Special 's', Conquest, Countess, B135, B190	9
BYB0242A00000	<b>Left Hand Coil - Chrome</b>	B135, B190	23
BMP0172A00000	<b>15/16" Bolt and Nut Assembly - Zinc</b>	B33	6
BMP0180A00000	<b>1" Bolt and Nut Assembly - Zinc</b>	B66, B66 's', B67, B67 's', Flyer, Flyer 's', Flyer Special, Flyer Special 's', B73, Conquest, Countess	6
<b>NOSE PARTS (LEATHER SADDLE)</b>			
BMP0173A00000	<b>Tension Pin Assembly 64mm with Nut - Zinc</b>	B17, B17 Narrow, Flyer, Flyer Special, Professional 's', B17 's', B66, B66 's', B73, B72, Flyer 's', Flyer 's' Special, Finesse, B67, B67 's', B68, B68 's', Swift/Swallow Chrome, Countess	10
BMP0185A00000	<b>Tension Pin assembly 60mm with Nut - Zinc</b>	Swift Titanium , B17 Titanium, Team Prof Titanium	7,50
BMP0306A00000	<b>Tension Pin 54mm - Zinc</b>	B33, B135	7,50
BYB0140A00000	<b>Tension Shackle - Chrome</b>	Team Professional, Professional 's', B17, B17 's', B17 Narrow, Flyer Special, Flyer Special 's', Swift/Swallow Chrome, B67, Conquest, Countess	7
BYB0289A00000	<b>Tension Shackle - Titanium</b>	Swift Titanium, Finesse, B17 Titanium, Team Prof	20
<b>RIVETS (LEATHER SADDLE)</b>			
BYB0421A00000	<b>Ø 8.75mm Solid Rivet can be used to replace tubrivets (3 pieces) - Nickel</b>	B66, B66 's', B67, B67 's', B73, B33, B17 Std, B17 Narrow, B72, Flyer, Flyer 's', Swallow, Aged Line	7
<b>MISCELLANEOUS</b>			
BMP0183A00000	<b>9/32" Nut - Zinc</b>	All Sprung saddles	3,50
HTR0129A00000	<b>Spanner</b>	All models with tension nut on the nose (Including Swallow/Swift Steel)	10,50
BYB0371A00000	<b>Rubber bar end plugs natural</b>	Bar tape Cambium	8,50
BYB0372A00000	<b>Rubber bar end plugs black</b>	Bar tape Cambium	8,50



# KASK



**Filippo Ganna**  
INEOS Grenadiers Cycling Team

# Record

KASK

INEOS  
GRENA DIERS  
CYCLING TEAM

339

## About KASK

KASK è un'azienda italiana fondata nel 2004 specializzata nello sviluppo, design e produzione di caschi di altissima qualità. Innovativa ed affascinante, l'intera collezione di KASK rappresenta un mix imbattibile di eccellenza tecnologica, funzionalità, sicurezza, comfort e di un design unico Made in Italy, dal fascino classico. Negli ultimi anni, KASK ha vinto importanti premi, tra cui l'IF Design Award, l'ISPO Award, il Red Dot Design Award, l'Eurobike Award e il premio 100 Eccellenze Italiane.

I caschi KASK possono essere utilizzati in qualsiasi disciplina ciclistica: strada, mountain bike, triathlon, pista, ciclocross e anche per il ciclismo in città. KASK collabora con una vasta gamma di squadre professionistiche e atleti di alto livello per creare caschi che spostano sempre più in là i limiti delle prestazioni.

Tra i partner nel mondo del ciclismo su strada ci sono il team britannico INEOS Grenadiers, il team Eolo Kometa Pro Cycling, il team femminile tedesco Ceratizit - WNT Pro Cycling, e i triatleti Lucy Charles-Barclay e Braden Currie. Numerose le partnership anche nel mondo mountain bike con la dieci volte campionessa del mondo elite Pauline Ferrand-Prevot e il team Bixis Performance Racing, così come nel mondo delle gare gravel con l'Enough Cycling Collective e l'australiano Nathan Haas. KASK è inoltre un orgoglioso partner delle Federazioni Ciclistiche Italiana e Australiana.



Elia Viviani  
INEOS Grenadiers Cycling Team

## **KASK WG11 Rotational impact test**

KASK è da sempre impegnata nella creazione di prodotti che garantiscono sicurezza e comfort ai massimi livelli, in grado di superare tutti i requisiti posti da norme e standard internazionali.

**Basato su un metodo oggettivo e scientifico, KASK ROTATIONAL IMPACT WG11 TEST è un protocollo interno adottato da KASK per misurare la performance dei suoi caschi in caso di impatto rotazionale.**

La maggior parte dei test condotti su caschi avviene utilizzando tecnologie di prevenzione che impiegano modelli di testa il cui coefficiente di frizione è molto più alto di quello di una testa umana. Questi test potrebbero quindi non riprodurre da ciò che realmente accade in alcuni incidenti.

Il criterio "pass/fail" si basa sul valore BrIC, un algoritmo che definisce l'entità dei danni al cervello. Questo valore deve essere inferiore a 0,68.

### **Il protocollo finale del test è:**

#### TEST IMPATTO OBLIQUO

Test obliqui a 45°, velocità di impatto 6 m/s, BrIC < 0,68  
+ tela abrasiva grana 80 con rivestimento in ossido di alluminio  
+ modello testa con coefficiente nominale di frizione pari a 0,3  
+ sistema wireless: accelerometro triassiale + n. 3 ARS  
Modello testa: serie EN960  
Misurazioni: picco di accelerazione rotazionale, picco di accelerazione lineare, HIC, BRIC (<0,68)

**Tutti i caschi KASK hanno superato questo test con successo, con valori sostanzialmente inferiori a BrIC 0,390.**

(\*) KASK ROTATIONAL IMPACT WG11 TEST PASSED è un marchio registrato di KASK. Il KASK ROTATIONAL IMPACT WG11 TEST PASSED è un test a impatto obliquo adottato da KASK internamente per misurare la performance dei propri caschi in caso di impatto rotazionale. Questo test non è utilizzato da CEN o dai Working Group CEN TC158 / Working Group 11.



## 0.68

### Valore massimo BrIC (Brain Injury Criteria)

Il valore BrIC è un algoritmo che definisce l'entità dei danni al cervello. Questo valore deve essere inferiore a 0,68 – più il valore è basso, minori sono i danni.

## 0.39

Il nostro valore BrIC non supera mai 0,39.

## LAB TESTED. ROAD APPROVED.

KASK ha creato KASK ROTATIONAL IMPACT WG11 TEST per fornire caschi più sicuri. Uno strato di protezione invisibile che supera ampiamente i requisiti delle norme internazionali. Il protocollo di sicurezza indipendente testato in laboratorio sfida il settore e supera gli standard più elevati. Grazie al nostro background scientifico e a test intensivi, siamo in grado di creare una protezione per la testa che supera facilmente anche le procedure di test più rigorose. Ci impegniamo a rispettare gli standard più elevati per la tua sicurezza durante tutte le tue uscite in bicicletta.

 **6 m/s**

### Testato per impatto rotazionale

Per la riduzione dell'impatto rotazionale testiamo tutti i nostri caschi a una velocità minima di 6 m/s e basandoci su scenari realistici e scientifici.



Scopri di più su [kask.com/safety](https://www.kask.com/safety)  
o scansiona il codice.



# Road



# Elemento



## DETTAGLI TECNICI

■■■■■■■■■■  
VENTILAZIONE

■■■■■■■■■■  
AERODINAMICA

### DESTINAZIONE D'USO

Road  
Cyclocross  
MTB Cross-Country

### STANDARDS

CE EN 1078

### TAGLIE

S 50/56 cm  
M 52/58 cm  
L 59/62 cm

### PESO

260g (M size)



# Elemento

VIRGINIA TECH.  
HELMET RATING  
5 ★★★★★



## ACCESSORI



IMBOTTITURA  
INVERNALE



IMBOTTITURA  
INTERNA

ARTICLE	MODEL	CATEGORY	TYPE OF USE	COLOR	SIZE	WEIGHT	PRICE (€)
CHE00101201	<b>Elemento WG11</b>	Road	Road	White	S,M,L	260g (M size)	375
CHE00101210			Cyclocross MTB Cross-Country	Black	S,M,L		375

# Utopia Y



## DETTAGLI TECNICI

■■■■■■■■■■  
VENTILAZIONE

■■■■■■■■■■  
AERODINAMICA

### DESTINAZIONE D'USO

Road  
Triathlon

### STANDARDS

CE EN 1078

### TAGLIE

S 50/56 cm  
M 52/58 cm  
L 59/62 cm

### PESO

260g (M size)



# Utopia Y



## ACCESSORI



IMBOTTITURA  
INVERNALE



IMBOTTITURA  
INTERNA

ARTICLE	MODEL	CATEGORY	TYPE OF USE	COLOR	SIZE	WEIGHT	PRICE (€)
CHE00104201	<b>Utopia Y WG11</b>	Road	Road Triathlon	White	S,M,L	260g (M size)	275
CHE00104210				Black	S,M,L		275

# Protone Icon



## DETTAGLI TECNICI

  
 VENTILAZIONE

  
 AERODINAMICA

### DESTINAZIONE D'USO

Road  
 Cyclocross  
 Gravel  
 MTB Cross-Country

### STANDARDS

CE EN 1078

### TAGLIE

S 50/56 cm  
 M 52/58 cm  
 L 59/62 cm

### PESO

230g (M size)



# Protone Icon



## ACCESSORI



IMBOTTITURA  
INVERNALE



IMBOTTITURA  
INTERNA

ARTICLE	MODEL	CATEGORY	TYPE OF USE	COLOR	SIZE	WEIGHT	PRICE (€)
CHE00097210				Black	S,M,L		275
CHE00097201			Road	White	S,M,L		275
CHE00097313	<b>Protone Icon WG11</b>	Road	Cyclocross	Grey	S,M,L	230g (M size)	275
CHE00097218			Gravel	Light Blue	M,L		275
CHE00097204			MTB Cross-Country	Red	M,L		275

# Protone Icon



ARTICLE	NEW	MODEL	CATEGORY	TYPE OF USE	COLOR	SIZE	WEIGHT	PRICE (€)
CHE00097459	<b>NEW</b>	<b>Protone Icon WG11</b>	Road	Road	Tangerine MATT	S,M,L	230g (M size)	275
CHE00097460	<b>NEW</b>			Cyclocross	Sahara MATT	S,M,L		275
CHE00097211				Gravel	Black MATT	S,M,L		275
CHE00097321				MTB Cross-Country	White MATT	S,M,L		275
CHE00097389					Grey MATT	S,M,L		275
CHE00097256					Blue MATT	M,L		275
CHE00097390					Olive Green MATT*	S,M,L		275

(\*) Disponibile fino ad esaurimento scorte







## DETTAGLI TECNICI

■■■■■■■■■■  
VENTILAZIONE

■■■■■■■■■■  
AERODINAMICA

### DESTINAZIONE D'USO

Road  
Cyclocross  
Gravel  
MTB Cross-Country

### STANDARDS

CE EN 1078

### TAGLIE

S 50/56 cm  
M 52/58 cm  
L 59/62 cm

### PESO

180g (S size)



# Valegro



## ACCESSORI



IMBOTTITURA  
INVERNALE



IMBOTTITURA  
INTERNA

ARTICLE	MODEL	CATEGORY	TYPE OF USE	COLOR	SIZE	WEIGHT	PRICE (€)
CHE00052210	<b>Valegro WG11</b>	Road	Road	Black	S,M,L	180g (S size)	209
CHE00052201			Cyclocross	White	S,M,L		209
CHE00052211			Gravel MTB Cross-Country	Black MATT	S,M,L		209

# Mojito<sup>3</sup>



## DETTAGLI TECNICI

■■■■■  
VENTILAZIONE

■■■■■  
AERODINAMICA

### DESTINAZIONE D'USO

Road  
Gravel  
MTB Cross-Country

### STANDARDS

CE EN 1078

### TAGLIE

S 50/56 cm  
M 52/58 cm  
L 59/62 cm

### PESO

230g (M size)



# Mojito<sup>3</sup>



## ACCESSORI



IMBOTTITURA  
INVERNALE



IMBOTTITURA  
INTERNA

ARTICLE	MODEL	CATEGORY	TYPE OF USE	COLOR	SIZE	WEIGHT	PRICE (€)
CHE00076201	<b>Mojito<sup>3</sup> WG11</b>	Road	Road Gravel MTB Cross-Country	White	S,M,L	230g (M size)	149
CHE00076210				Black	S,M,L		149
CHE00076313				Grey	S,M,L		149
CHE00076221				Yellow FLUO	S,M,L		149
CHE00076222				Orange FLUO	S,M,L		149

# Mojito<sup>3</sup>



ARTICLE	MODEL	CATEGORY	TYPE OF USE	COLOR	SIZE	WEIGHT	PRICE (€)
CHE00076216	<b>Mojito<sup>3</sup> WG11</b>	Road	Road Gravel MTB Cross-Country	Bicolor White/Black	S,M,L	230g (M size)	149
CHE00076226				Bicolor Black/Red	S,M,L		149
CHE00076241				Bicolor White/Red	S,M,L		149
CHE00076438				Bicolor Grey/Black	S,M,L		149
CHE00076211				Black MATT	S,M,L		149
CHE00076321				White MATT*	S,M,L		149
CHE00076389				Grey MATT*	S,M,L		149
CHE00076390				Olive Green MATT*	S,M,L		149

(\*) Disponibili fino ad esaurimento scorte





## DETTAGLI TECNICI

  
 VENTILAZIONE

  
 AERODINAMICA

### DESTINAZIONE D'USO

Leisure  
 Urban  
 Road  
 Gravel

### STANDARDS

CE EN 1078

### TAGLIE

M 52/58 cm  
 L 59/62 cm

### PESO

230g (M size)



# Sintesi



## ACCESSORI



IMBOTTITURA  
INVERNALE



IMBOTTITURA  
INTERNA

ARTICLE	MODEL	CATEGORY	TYPE OF USE	COLOR	SIZE	WEIGHT	PRICE (€)
CHE00100201				White	M,L		100
CHE00100210			Leisure	Black	M,L		100
CHE00100204	<b>Sintesi WG11</b>	Road	Urban Road	Red	M,L	230g (M size)	100
CHE00100313			Gravel	Grey	M,L		100
CHE00100446				Sahara	M,L		100





## DETTAGLI TECNICI

  
 VENTILAZIONE

  
 AERODINAMICA

### DESTINAZIONE D'USO

Road  
Cyclocross  
Gravel

### STANDARDS

CE EN 1078

### TAGLIE

S 50/56 cm  
M 52/58 cm  
L 59/62 cm

### PESO

280g (M size)



# Wasabi



## ACCESSORI



IMBOTTITURA  
INVERNALE



IMBOTTITURA  
INTERNA

ARTICLE	MODEL	CATEGORY	TYPE OF USE	COLOR	SIZE	WEIGHT	PRICE (€)
CHE00093211	<b>Wasabi WG11</b>	Road	Road	Black MATT	S,M,L	280g (M size)	300
CHE00093321			Cyclocross Gravel	White MATT	S,M,L		



**MTB**

# Rex



## DETTAGLI TECNICI



VENTILAZIONE

## DESTINAZIONE D'USO

Enduro  
Trail

## STANDARDS

CE EN 1078

## TAGLIE

M 52/58 cm  
L 59/62 cm

## PESO

310g (M size)



# Rex



## ACCESSORI



IMBOTTITURA  
INVERNALE



IMBOTTITURA  
INTERNA



FRONTINO  
MTB

ARTICLE	MODEL	CATEGORY	TYPE OF USE	COLOR	SIZE	WEIGHT	PRICE (€)
CHE00038210	<b>Rex WG11</b>	Off-Road	Enduro Trail	Black	M,L	310g (M size)	229



## DETTAGLI TECNICI



VENTILAZIONE

### DESTINAZIONE D'USO

Trail  
Gravel  
MTB Cross-Country

### STANDARDS

CE EN 1078

### TAGLIE

M 52/58 cm  
L 59/62 cm

### PESO

250g (M size)



# Caipi



## ACCESSORI



IMBOTTITURA  
INVERNALE



IMBOTTITURA  
INTERNA

ARTICLE	MODEL	CATEGORY	TYPE OF USE	COLOR	SIZE	WEIGHT	PRICE (€)
CHE00065210	<b>Caipi WG11</b>	Off-Road	Trail	Black	M,L	250g (M size)	139
CHE00065201			Gravel MTB Cross-Country	White	M,L		139





91123

**Aero**

# Mistral



## DETTAGLI TECNICI

■■■■■  
VENTILAZIONE

■■■■■  
AERODINAMICA

### DESTINAZIONE D'USO

Track  
Time Trial  
Triathlon

### STANDARDS

CE EN 1078

### TAGLIE

M 52/58 cm  
L 59/62 cm

### PESO

340g (M size)



# Mistral



## ACCESSORI



VISIERA MAGNETICA  
ARGENTO



IMBOTTITURA  
INTERNA

ARTICLE	MODEL	CATEGORY	TYPE OF USE	COLOR	SIZE	WEIGHT	PRICE (€)
CHE00050285	<b>Mistral</b>	Aero	Track Time Trial Triathlon	Black/Anthracite + Clear Visor	M,L	340g (M size)	349*

(\*) Visiera trasparente inclusa

# Bambino Pro

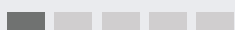

## DETTAGLI TECNICI

  
 VENTILAZIONE

  
 AERODINAMICA

### DESTINAZIONE D'USO

Track  
 Time Trial  
 Triathlon

### STANDARDS

CE EN 1078

### TAGLIE

M 52/58 cm  
 L 59/62 cm

### PESO

340g (M size)



# Bambino Pro



## ACCESSORI



VISIERA MAGNETICA  
TRASPARENTE

VISIERA MAGNETICA  
ARANCIO

VISIERA MAGNETICA  
ARGENTO

IMBOTTITURA  
INVERNALE

IMBOTTITURA  
INTERNA

ARTICLE	MODEL	CATEGORY	TYPE OF USE	COLOR	SIZE	WEIGHT	PRICE (€)
CHE00042211	<b>Bambino Pro</b>	Aero	Track Time Trial Triathlon	Black MATT + Clear Visor	M,L	340g (M size)	349*

(\*) Visiera trasparente inclusa



FENCHURCH AVENUE EC3

STEVENS

STEVENS

011

011

011

011

# Urban



# Moebius



## DETTAGLI TECNICI



VENTILAZIONE

### DESTINAZIONE D'USO

Commuting

### STANDARDS

CE EN 1078

### TAGLIE

M 52/58 cm  
L 59/62 cm

### PESO

410g (M size)



# Moebius



## ACCESSORI



IMBOTTITURA  
INTERNA

ARTICLE	MODEL	CATEGORY	TYPE OF USE	COLOR	SIZE	WEIGHT	PRICE (€)
CHE00090228	<b>Moebius WG11</b>	Urban	Commuting	Onyx MATT	M,L	410g (M size)	99
CHE00090238				Ivory MATT	M,L		99
CHE00090239				Champagne MATT	M,L		99
CHE00090349				Ash MATT	M,L		99

# Accessories

# Accessories

## Winter Cap

Il cappello in lana merino KASK funge da strato base per il casco, proteggendo la testa dal vento gelido e mantenendoti al caldo durante le pedalate invernali più fredde.

L'imbottitura interna in lana merino mantiene stabile la temperatura corporea, assicura un'elevata traspirazione e si asciuga rapidamente. Il tessuto esterno in Tekseries garantisce una significativa resistenza al freddo e al vento, combinata con un alto livello di traspirabilità e resistenza all'acqua. Per indossare il cappello, basta rimuovere l'imbottitura interna del casco e far aderire il cappello al velcro.

Il cappello invernale è disponibile in tre taglie ed è compatibile con la maggior parte dei nostri caschi.



ARTICLE	MODEL	SIZE	PRICE (€)
CPA00021000	<b>WINTER CAP</b> imbottitura interna di ricambio universale	S,M,L	49,90

# Accessories

## Internal Pad

L'imbottitura dei caschi KASK è antistatica, batteriostatica, regola il calore e elimina l'umidità. Quando le imbottiture interne si usurano, è possibile avere un set di imbottiture di ricambio, specifico per ogni prodotto KASK. Ogni set di imbottiture di ricambio è facile da installare, semplicemente attaccandolo alle sezioni in velcro del casco.



ELEMENTO



UTOPIA Y



PROTONE ICON



VALEGRO



MOJITO³



SINTESI



WASABI



REX



CAIPI



BAMBINO PRO/MISTRAL



MOEBIUS

ARTICLE	NEW	MODEL	SIZE	PRICE (€)
CPA00033000	<b>NEW</b>	<b>ELEMENTO</b> imbottitura interna di ricambio	S,M,L	20
CPA00031000U	<b>NEW</b>	<b>UTOPIA Y</b> imbottitura interna di ricambio	universal	20
CPA00030000		<b>PROTONE ICON</b> imbottitura interna di ricambio	S,M,L	20
CPA00017000		<b>VALEGRO</b> imbottitura interna di ricambio	M,L	16,50
CPA00025000		<b>MOJITO³</b> imbottitura interna di ricambio	S,M,L	15
CPA00032000		<b>SINTESI</b> imbottitura interna di ricambio	M,L	20
CPA00029000		<b>WASABI</b> imbottitura interna di ricambio	M,L	25
CPA00014000U		<b>REX</b> imbottitura interna di ricambio	universal	14,50
CPA00022000U		<b>CAIPI</b> imbottitura interna di ricambio	universal	15
CPA00015000U		<b>BAMBINO PRO/MISTRAL</b> imbottitura interna di ricambio	universal	16,50
CPA00027000U		<b>MOEBIUS</b> imbottitura interna di ricambio	universal	15

# Accessories

## Visor

Tutti i caschi aero KASK sono dotati di una visiera magnetica facilmente rimovibile. La visiera magnetica per i caschi aero è disponibile in due varianti di colore: trasparente e specchiata.



**BAMBINO PRO**



**BAMBINO PRO**



**MISTRAL**

ARTICLE	MODEL	SIZE	PRICE (€)
CVI00009500	<b>BAMBINO PRO visiera magnetica trasparente</b>	M,L	45
CVI00009520	<b>BAMBINO PRO visiera magnetica argento</b>	M,L	69,50
CVI00013520	<b>MISTRAL visiera magnetica argento</b>	M,L	69,50

# Legend

---



## CONTROLLO FLUSSO D'ARIA

Calotta estremamente aerodinamica e performante testata nella galleria del vento in grado di offrire un coefficiente di penetrazione all'aria molto vantaggioso e di garantire un deflusso dell'aria sempre in linea con il casco, qualsiasi posizione la testa assuma.



## VISIERA MAGNETICA

Tra le tecnologie brevettate KASK spicca l'innovativa visiera magnetica. La totale aderenza della visiera al casco grazie alla presenza di cinque magneti permette un flusso dell'aria continuo e un'elevata aerodinamicità.



## REGOLATORE OCTO

Rotellina micrometrica gommata per un ottimo fit. Braccetti ergonomici e scheletrici disegnati per garantire la migliore calzata e la massima leggerezza.



## SISTEMA DI RITENZIONE OCTO FIT PLUS

La nuova rotella in gomma sovrainiettata offre una migliore presa. Lo stabilizzatore verticale è stato ridisegnato per una maggiore stabilità e una vestibilità personalizzata per i ciclisti con capelli più lunghi. Il supporto ergonomico per il collo assicura una un'aderenza rapida e sicura alla nuca.



## SOTTOGOLA IN PELLE SINTETICA

Il sottogola in pelle sintetica anallergica e lavabile. Soffice al tatto, evita le irritazioni alla pelle e, regolabile in lunghezza, migliora il comfort della calzata.



## TELAIO DI RINFORZO

Telaio di rinforzo per una maggiore resistenza meccanica. In caso di urto evita la rottura del casco in più parti.



## ADESIVI RIFRANGENTI

Adesivi rifrangenti per la massima sicurezza anche in condizioni di luminosità ridotte.



## IMBOTTITURA 3D DRY

Imbottitura tridimensionale 3D DRY basata sulla metodologia di costruzione multistrato a cellule aperte: alta tecnologia per il massimo comfort e prestazioni eccellenti.



## FLUID CARBON 12

Un nuovo materiale composito che permette di ridurre lo spessore dell'EPS della calotta interna migliorando ventilazione e aerodinamica. Genera anche una migliore distribuzione dell'energia in caso di urto e garantisce una frizione minore tra il casco e la superficie dell'impatto.



## FIBRA COOLMAX®



## VISIERA REGOLABILE

La visiera può essere regolata in differenti posizioni, per una visibilità ottimale.



## MULTIPOD

Un materiale isotropo che permette una gestione migliore dell'energia creata da un impatto rotazionale e aumenta la ventilazione. Si comporta allo stesso modo indipendentemente dalla direzione da cui è applicata la forza e riduce lo stress tangenziale tra la testa e l'interno del casco.

# Legend

---



## LANA MERINO

Realizzato con un sottile filato di lana merino e poliammide, leggero, coprente e con eccellenti proprietà di termoregolazione.



## CALOTTA IN ABS

Calotta esterna del casco costruita in ABS durevole e anti-graffio.



## ACTIVE VENTILATION SYSTEM

L'Active Ventilation System integrato nel casco consente un migliore raffreddamento. Grazie alla leva sul retro la quantità del flusso d'aria può essere regolata per adattarsi alle esigenze del rider. Questo nuovo sistema di ventilazione, unito con le imbottiture interne traspiranti, migliora il fisiologico comfort del ciclista.



## ERGO FIT

Un sistema di regolazione tutto nuovo sviluppato per migliorare vestibilità e comfort. La rotella ridisegnata offre un migliore grip per gestire le microregolazioni, mentre l'estetica e il design aggiornati si traducono in un nuovo sistema di regolazione che assicura comfort e vestibilità.



## MULTI IN/MOULDING TECNOLOGY

La tecnologia MIT, applicata a tutti i modelli della linea ciclismo KASK, garantisce una maggiore sicurezza e una protezione completa grazie alla copertura in policarbonato della calotta sulla parte superiore, sull'anello perimetrale di base e sul posteriore.



## ANTISTATIC

Il materiale dell'imbottitura, data la sua conduttività, assorbe e disperde la carica elettrica presente nell'ambiente.



## SOTTOGOLA IN COTONE

Elegante sottogola realizzato con un resistente tessuto di cotone per ottenere comfort e resistere allo stiramento.



## BLUE TECH PADDING

Il materiale dell'imbottitura offre un'elevata traspirabilità ed è caratterizzato da proprietà antibatteriche e antistatiche.



## HYVENT

La struttura e il design della calotta favoriscono la ventilazione e lo scambio di calore.



## RESISTEX® CARBON



KCO  
eyewear





Eolo Kometa Cycling Team  
©maurizioborserini

**KOO EYEWEAR**

**387**



## A B O U T K O O

KOO Eyewear è un innovativo brand sportivo specializzato nello sviluppo, progettazione e produzione di occhiali da sole e maschere di altissima qualità in ambito sportivo. L'impegno di KOO Eyewear è sviluppare occhiali, interamente progettati e realizzati in Italia, dal forte contenuto tecnico che fondono eccellenza tecnologica, materiali premium e un design iconico. I prodotti KOO Eyewear sono realizzati secondo i più alti standard, con test rigorosi per garantire qualità e sicurezza, grazie anche alla partnership con Zeiss®, azienda di riferimento mondiale nella produzione di lenti in grado di fornire soluzioni con visibilità e protezione senza pari.

KOO Eyewear è al fianco di numerosi team professionistici e atleti di alto livello, con i quali collabora per sviluppare prodotti sempre più performanti. Tra questi troviamo le squadre di ciclismo su strada, il team EOLO KOMETA Pro Cycling, il Team Colpack, la formazione femminile Ceratizit-WNT Pro Cycling. Numerose le partnership con singoli atleti di varie discipline: dal gravel con Nathan Haas al running con Henri Aymonod e Silvia Ainhoa Trigueros Garrote, passando al triathlon dove KOO Eyewear sostiene numerosi atleti, tra cui Giulio Molinari e Andy Potts. Tra gli ambassador figurano gli ex ciclisti professionisti Alberto Contador e Ivan Basso.

# ALIBI

NEW

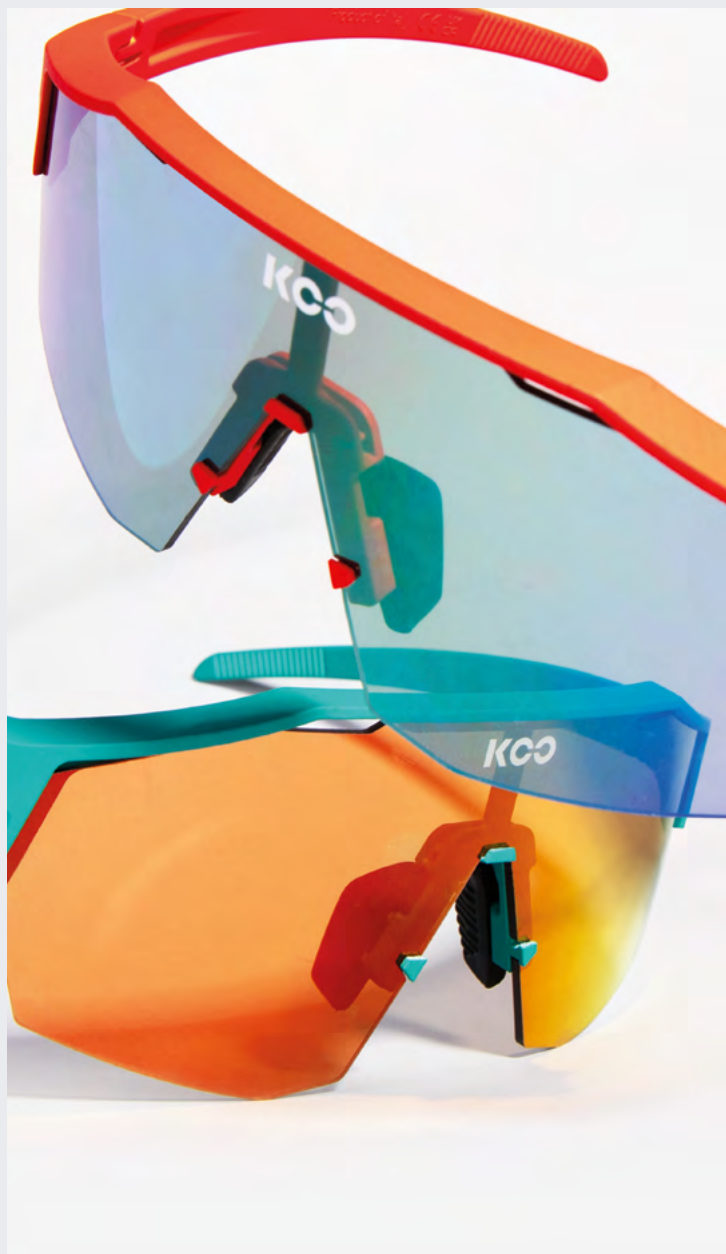

Con il suo innovativo ed elegante "half frame design", dalla struttura aperta, ALIBI si adatta perfettamente sia alla strada sia ai percorsi gravel, offrendo un'esperienza di guida unica e versatile. Realizzato appositamente per soddisfare le misure più piccole e grazie alla sua struttura, ALIBI garantisce visibilità ampia e eccezionale, eliminando qualsiasi ostacolo alla visuale nella parte inferiore e consentendo ai ciclisti di godersi una ride senza limiti.

## DESTINAZIONE D'USO

Road  
Gravel

## MISURA E VESTIBILITÀ

Regular  
Nasello a ponte disponibile  
Disponibile il nasello con vestibilità asiatica

## ALIBI

NEW



**WHITE MATT PHOTOCHROMIC**  
PHOTOCHROMIC FUCHSIA MIRROR LENS  
CAT. 1-3 - VLT 75-12%



**ORANGE MATT GREEN**  
GREEN MIRROR LENS  
CAT. 2 - VLT 22%



**GREY MATT TURQUOISE**  
TURQUOISE MIRROR LENS  
CAT. 3 - VLT 11%



**BLACK MATT GOLD**  
GOLD MIRROR LENS  
CAT. 3 - VLT 17%

LENS BY 

## CARATTERISTICHE TECNICHE



// Stanghette curve



// Nasello confortevole



// Compatibile con clip vista

ARTICLE	EAN	NEW	MODEL	COLOR	LENS	SIZE	PRICE (€)
OEY00009963	8057099311335	<b>NEW</b>		White MATT	Photochromic Fuchsia Mirror	Unica	220
OEY00009964	8057099311342	<b>NEW</b>	<b>ALIBI</b>	Orange MATT	Green Mirror	Unica	180
OEY00009966	8057099311366	<b>NEW</b>	<b>sunglasses</b>	Grey MATT	Turquoise Mirror	Unica	180
OEY00009970	8057099311403	<b>NEW</b>		Black MATT	Gold Mirror	Unica	180

# SUPERNOVA



Occhiali da sole con struttura senza montatura per il running, il ciclismo e altre attività sportive dove la leggerezza, la calzatura perfetta e la visione panoramica sono essenziali. La vestibilità avvolgente conferisce sicurezza e protezione dalla luce intensa, da eventuali detriti e dal vento. Da parte loro le lenti toriche in Nylon sono state sviluppate in collaborazione con Zeiss®: sono la migliore opzione per avere lenti leggere con una visione chiara.

## DESTINAZIONE D'USO

Multi-Sport

## MISURA E VESTIBILITÀ

Regular  
Disponibile il nasello con vestibilità asiatica



NEW



**BLACK MATT PHOTOCHROMIC\***  
PHOTOCHROMIC PINK LENS  
CAT. 1-3 - VLT 73-11%



**BLACK MATT GREEN**  
GREEN MIRROR LENS  
CAT. 2 - VLT 23%



**YELLOW FLUO RED**  
RED MIRROR LENS  
CAT. 2 - VLT 20%



**WHITE TURQUOISE**  
TURQUOISE MIRROR LENS  
CAT. 3 - VLT 12%



**WHITE RED**  
RED MIRROR LENS  
CAT. 2 - VLT 20%

## CARATTERISTICHE TECNICHE



// Super Leggero



// Tecnologia Antigravity per una calzata sicura

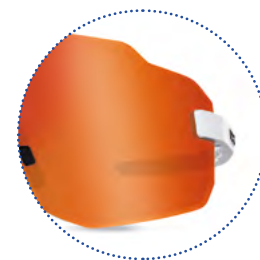

// Lenti toriche in nylon ZEISS®

ARTICLE	EAN	NEW	MODEL	COLOR	LENS	SIZE	PRICE (€)
OEY00007944	8057099291217	<b>NEW</b>	<b>SUPERNOVA sunglasses</b>	Black MATT	Photochromic Pink	Unica	210
OEY00007912	8057099240918			Black MATT	Green Mirror	Unica	179
OEY00007902	8057099240956			Yellow FLUO	Red Mirror	Unica	179
OEY00007699	8057099240925			White	Turquoise Mirror	Unica	179
OEY00007908	8057099240949			White	Red Mirror	Unica	179

(\*) Le caratteristiche tecniche si riferiscono all'intera collezione ad eccezione del modello SUPERNOVA Black Matt Fotocromatico (lenti in policarbonato)





Oltre a un peso ultraleggero di 21 grammi, NOVA è dotato di caratteristiche tecniche che lo rendono leader nella categoria degli occhiali da trail running. La calzata sicura e avvolgente conferisce a NOVA una forma aerodinamica senza eguali, con una resistenza minima per la corsa in diverse condizioni. Le lenti toriche in nylon ZEISS® sono perfette per i trail runner che desiderano occhiali in grado di adattarsi a condizioni di luce e terreno variabili, senza alterare i colori circostanti.

## DESTINAZIONE D'USO

Running

## MISURA E VESTIBILITÀ

Regular  
Disponibile il nasello con vestibilità asiatica

LENS BY



**BLACK MATT FUCHSIA**  
FUCHSIA MIRROR LENS  
CAT 3 - VLT 12%



**OLIVE GREEN MATT ORANGE**  
ORANGE MIRROR LENS  
CAT 2 - VLT 20%

## CARATTERISTICHE TECNICHE



// Lenti toriche in nylon ZEISS®



// Nasello a ponte ventilato



// Peso ultraleggero di 21 grammi

ARTICLE	EAN	MODEL	COLOR	LENS	SIZE	PRICE (€)
OEY00006919	8057099283694	<b>NOVA</b>	Black MATT	Fuchsia Mirror	Unica	179
OEY00006921	8057099283717	<b>sunglasses</b>	Olive Green MATT	Orange Mirror	Unica	179

# DEMOS



Gli occhiali da sole DEMOS sono progettati per i ciclisti su strada e off-road, in particolare per quelli che cercano l'avventura e per chi fa ciclocross. 100% Made in Italy, sono disponibili con lenti di diversi colori per adattarsi alle diverse condizioni di illuminazione.

## DESTINAZIONE D'USO

Strada  
Ciclocross  
Fuori Strada

## MISURA E VESTIBILITÀ

Regular  
Disponibile il nasello con vestibilità asiatica

## DEMOS

LENS BY



**WHITE PHOTOCROMIC**  
PHOTOCROMIC PINK LENS  
CAT. 1 - 3 - VLT 12,5-69%



**WHITE TURQUOISE**  
TURQUOISE MIRROR LENS  
CAT. 3 - VLT 11%



**WHITE BROWN**  
BROWN LENS  
CAT. 2 - VLT 23%



**BLACK GREEN**  
GREEN MIRROR LENS  
CAT. 2 - VLT 23%



**BLUE**  
TURQUOISE MIRROR LENS  
CAT. 3 - VLT 11%



**GLASS RED**  
RED MIRROR LENS  
CAT. 2 - VLT 23%



**BLACK MATT**  
RED MIRROR LENS  
CAT. 2 - VLT 23%

## CARATTERISTICHE TECNICHE



// Visione panoramica migliorata



// Nasello regolabile e personalizzabile

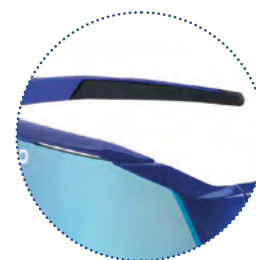

// Grip e Comfort superiori

ARTICLE	EAN	MODEL	COLOR	LENS	SIZE	PRICE (€)
OEY00005907	8057099240765	<b>DEMOS sunglasses</b>	White	Photochromic Pink	Unica	190
OEY00005699	8057099222099		White	Turquoise Mirror	Unica	159
OEY00005900	8057099222105		White	Brown	Unica	159
OEY00005616	8057099222051		Black	Green Mirror	Unica	159
OEY00005208	8057099222044		Blue	Blue Mirror	Unica	159
OEY00005697	8057099222075		Glass	Red Mirror	Unica	159
OEY00005918	8057099285957		Black MATT	Red Mirror	Unica	180

# SPECTRO



Gli occhiali da sole SPECTRO sono progettati per chi ama la velocità e per chi cerca sempre di battere i record, in particolare i ciclisti su strada e i triatleti. 100% Made in Italy, sono disponibili con lenti di diversi colori per adattarsi alle diverse condizioni di illuminazione.

## DESTINAZIONE D'USO

Strada  
Triathlon

## MISURA E VESTIBILITÀ

Regular  
Disponibile il nasello con vestibilità asiatica

LENS BY



**BLACK PHOTOCROMIC**  
PHOTOCROMIC PINK LENS  
CAT. 1 - 3 - VLT. 12,5 - 69%



**WHITE GREEN**  
GREEN MIRROR LENS  
CAT. 2 - VLT 23%



**BLACK RED**  
RED MIRROR LENS  
CAT. 2 - VLT 23%

## CARATTERISTICHE TECNICHE



// Superba visione panoramica



// Nasello pieghevole regolabile

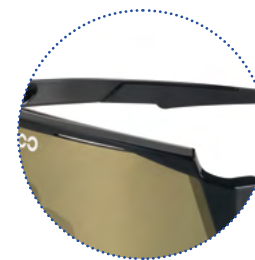

// Grip e comfort extra

ARTICLE	EAN	MODEL	COLOR	LENS	SIZE	PRICE (€)
OEY00004906	8057099240758	<b>SPECTRO sunglasses</b>	Black	Photochromic Pink	Unica	200
OEY00004694	8057099222006		White	Green Mirror	Unica	179
OEY00004659	8057099221993		Black	Red Mirror	Unica	179



Gli occhiali da sole COSMO sono un modello lifestyle che unisce design e performance. COSMO presenta un design iconico con uno stile raffinato e un tocco di originalità. Le lenti in policarbonato ZEISS® garantiscono eccezionali qualità ottiche.

## DESTINAZIONE D'USO

Performance Lifestyle

## MISURA E VESTIBILITÀ

One Size

LENS BY 



**BLACK MATT**  
POLARIZED LENS  
CAT 3 - VLT 11%



**BLONDE MATT**  
CLASSIC GREEN LENS  
CAT 2 - VLT 24%



**CRYSTAL**  
VIOLET MIRROR LENS  
CAT 2 - VLT 21%

**CARATTERISTICHE TECNICHE**



// Stanghette in Gomma Aderente

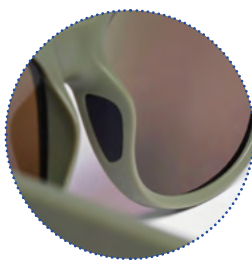

// Nasello in Gomma Aderente



// Lenti Polarizzate

ARTICLE	EAN	MODEL	COLOR	LENS	SIZE	PRICE (€)
OEY00008924	8057099283786	<b>COSMO sunglasses</b>	Black MATT	Polarized	Unica	150
OEY00008925	8057099283793		Blonde MATT	Classic Green	Unica	120
OEY00008926	8057099283809		Crystal	Violet Mirror	Unica	120





## IL SUPPORTO OCCHIALI DA BICICLETTA

Billy è un supporto per occhiali sportivi da montare sulla bicicletta: offre un posto pratico e sicuro dove alloggiare gli occhiali quando non utilizzati. Billy rende l'accesso agli occhiali facile: non dovrai più armeggiare nel cercare i tuoi occhiali da sole inseriti nel casco oppure alloggiati nelle tasche posteriori della maglia. Billy è disegnato per non interferire con altri dispositivi montati sul manubrio, come misuratori di potenza o cycling-computer. Billy è compatibile con tutti gli occhiali sportivi con montatura unica; è un utilissimo accessorio per occhiali da utilizzare quando sali le salite a basse velocità e quindi puoi pedalare senza proteggere gli occhi da corpi estranei, dal brutto tempo o dalle gocce di sudore. Billy è utilizzabile per il ciclismo su strada e per il triathlon.

### CARATTERISTICHE

- Compatibile con gli occhiali con montatura unica
- Pratico e sicuro
- Facile da installare e rimuovere
- Leggero (4g)
- Utilizzabile per il ciclismo su strada e il triathlon

ARTICLE	EAN	MODEL	COLOR	SIZE	QUANTITY	PRICE (€)
OAC00002	8057099141680	<b>BILLY</b> sunglasses bike mount	black	unica	24 pezzi	19,90

## OPTICAL CLIP EVO



## CLIP OTTICO PER L'APPLICAZIONE DI LENTI GRADUATE

Il Clip Ottico consente di montare lenti oftalmiche sugli occhiali da sole KOO Alibi, Spectro e Demos.

### CARATTERISTICHE

Nuovo design  
 Compatibile con ALIBI, SPECTRO  
 e DEMOS  
 Pratico e sicuro  
 Rapido da installare e rimuovere  
 Leggero (1,8g)  
 Lenti demo aggiuntive

ARTICLE	EAN	NEW	MODEL	COLOR	SIZE	QUANTITY	PRICE (€)
OAC00007210	8057099238168			Black	Unica	-	50
OAC00009468	8057099319881	<b>NEW</b>	<b>OPTICAL CLIP EVO</b>	Crystal	Unica	-	50

# ALIBI LENS



**PHOTOCHROMIC FUCHSIA MIRROR** ☁️ ☁️ ☀️  
 VLT% 75 - 12%  
 Filter Category 1-3  
 BEST FOR ROAD

**NEW**



**GREEN MIRROR** ☁️  
 VLT% 23%  
 Filter Category 2  
 BEST FOR MTB

**NEW**



**TURQUOISE MIRROR** ☀️  
 VLT% 11%  
 Filter Category 3  
 BEST FOR ROAD

**NEW**



**GOLD MIRROR** ☁️  
 VLT% 17%  
 Filter Category 3  
 BEST FOR ROAD

**NEW**

# DEMOS LENS



**PHOTOCHROMIC FUCHSIA MIRROR** ☁️ ☁️ ☀️  
 VLT% 75 - 12%  
 Filter Category 1-3  
 BEST FOR ROAD / MTB

**NEW**



**PHOTOCHROMIC PINK** ☁️ ☁️ ☀️  
 VLT% 69 - 12,5%  
 Filter Category 1-3  
 BEST FOR ROAD / MTB

**NEW**



**RED MIRROR** ☁️  
 VLT% 23%  
 Filter Category 2  
 BEST FOR ROAD / MTB



**TURQUOISE MIRROR** ☀️  
 VLT% 11%  
 Filter Category 3  
 BEST FOR ROAD



**GREEN MIRROR** ☁️  
 VLT% 23%  
 Filter Category 2  
 BEST FOR MTB



**ROSÈ** ☁️  
 VLT% 58%  
 Filter Category 1  
 BEST FOR ROAD



**BROWN** ☁️  
 VLT% 23%  
 Filter Category 2  
 BEST FOR MTB

ARTICLE	EAN	NEW	MODEL	LENS COLOR	SIZE	VLT%	FILTER CAT.	PRICE (€)
OLE00004554	8057099312431	<b>NEW</b>		Photochromic Fuchsia Mirror	Unica	75-12%	1	100
OLE00004518	8057099312387	<b>NEW</b>	<b>ALIBI lenses</b>	Gold Mirror	Unica	17%	3	70
OLE00004530	8057099312394	<b>NEW</b>		Green Mirror	Unica	23%	2	70
OLE00004543	8057099312370	<b>NEW</b>		Turquoise Mirror	Unica	11%	3	70
OLE00003554	8057099312356	<b>NEW</b>			Photochromic Fuchsia Mirror	Unica	75-12%	1-3
OLE00003544	8057099240789	<b>NEW</b>	<b>DEMOS lenses</b>	Photochromic Pink	Unica	69-12,5%	1-3	90
OLE00003519	8057099222259			Red Mirror	Unica	23%	2	70
OLE00003543	8057099222327			Turquoise	Unica	11%	3	70
OLE00003530	8057099222273			Green Mirror	Unica	23%	2	70
OLE00003539	8057099222280			Rosè	Unica	58%	1	40
OLE00003540	8057099222297			Brown	Unica	23%	2	40

VLT = VISIBLE LIGHT TRANSMISSION

# SPECTRO LENS



**ROSE**

☁️

VLT% 58%

Filter Category 1

BEST FOR ROAD



**RED MIRROR**

☁️

VLT% 23%

Filter Category 2

BEST FOR ROAD / MTB



**GREEN MIRROR**

☁️

VLT% 23%

Filter Category 2

BEST FOR MTB

ARTICLE	EAN	MODEL	LENS COLOR	SIZE	VLT%	FILTER CAT.	PRICE (€)
OLE00002539	8057099222181	<b>SPECTRO lenses</b>	Rosè	Unica	58%	1	40
OLE00002519	8057099222150		Red Mirror	Unica	23%	2	70
OLE00002530	8057099222174		Green Mirror	Unica	23%	2	70

**VLT** = VISIBLE LIGHT TRANSMISSION





# OVERVIEW

# Selle Royal

## ALL JOURNEYS RANGE

---



ON ATHLETIC  
€ 89,90



ON MODERATE  
€ 89,90



ON RELAXED  
€ 89,90

---



NEW

ON OPEN ATHLETIC  
€ 89,90



NEW

ON OPEN MODERATE  
€ 89,90



NEW

ON OPEN RELAXED  
€ 89,90

---



RESPIRO ATHLETIC  
€ 79,90



RESPIRO MODERATE  
€ 79,90



RESPIRO RELAXED  
€ 79,90

---



LOOKIN ATHLETIC  
€ 69,90



LOOKIN MODERATE  
€ 69,90



LOOKIN RELAXED  
€ 69,90

---



LOOKIN EVO ATHLETIC  
€ 74,90



LOOKIN EVO MODERATE  
€ 74,90



LOOKIN EVO RELAXED  
€ 74,90

---

## ADVENTURE TIME RANGE



VAIA ATHLETIC  
€ 69,90



VAIA MODERATE  
€ 69,90



VAIA RELAXED  
€ 69,90



EXPLORA ATHLETIC  
€ 69,90



EXPLORA MODERATE  
€ 69,90



EXPLORA RELAXED  
€ 69,90

## URBAN LIFE RANGE



ELLIPSE ATHLETIC  
€ 54,90



ELLIPSE MODERATE  
€ 54,90



ELLIPSE RELAXED  
€ 54,90



FREEWAY FIT ATHLETIC  
€ 44,90



FREEWAY FIT MODERATE  
€ 44,90



FREEWAY FIT RELAXED  
€ 44,90



FLOAT ATHLETIC  
€ 44,90



FLOAT MODERATE  
€ 44,90



FLOAT RELAXED  
€ 44,90



# Selle Royal

## URBAN LIFE RANGE



AVENUE ATHLETIC  
€ 39,90



AVENUE MODERATE  
€ 39,90



AVENUE RELAXED  
€ 39,90



VIVO ATHLETIC  
€ 29,90



DRIFTER STRENGTEX  
RELAXED  
€ 54,90



DRIFTER PLUS RELAXED  
€ 54,90



ONDINA RELAXED  
€ 34,90



HOLLAND RELAXED  
€ 29,90



WITCH RELAXED  
€ 19,90

## KIDS SADDLES RANGE



FROGGY / BOY & GIRL  
€ 19,90



CANDY / GIRL  
€ 19,90



BEN / BOY  
€ 19,90



HELLO / BOY & GIRL  
€ 19,90

## SADDLES BAGS



MEDIUM 1,2L  
€ 19,90



LARGE 2,0L  
€ 24,90



EXTRA LARGE 7,0L  
€ 59,90

## SEAT COVERS



ROYALGEL™ SMALL  
€ 19,90



ROYALGEL™ LARGE  
€ 19,90



SLOW FIT FOAM SMALL  
€ 19,90



SLOW FIT FOAM LARGE  
€ 19,90

## SCIENTIA RANGE



SCIENTIA A1 ATHLETIC  
SMALL  
€ 89,90



SCIENTIA A2 ATHLETIC  
MEDIUM  
€ 89,90



SCIENTIA A3 ATHLETIC  
LARGE  
€ 89,90



SCIENTIA M1 MODERATE  
SMALL  
€ 89,90



SCIENTIA M2 MODERATE  
MEDIUM  
€ 89,90



SCIENTIA M3 MODERATE  
LARGE  
€ 89,90



SCIENTIA R1 RELAXED  
SMALL  
€ 89,90



SCIENTIA R2 RELAXED  
MEDIUM  
€ 89,90



SCIENTIA R3 RELAXED  
LARGE  
€ 89,90

## REMED RANGE



REMED SPORT ATHLETIC  
€ 26,90



REMED TREKKING MODERATE  
€ 26,90



REMED CITY RELAXED  
€ 26,90

ROAD SADDLES



VENTO ARGO 00  
ADAPTIVE  
140mm/150mm  
€ 399



VENTO ARGO R1  
ADAPTIVE  
140mm/150mm  
€ 299



VENTO ARGO R3  
ADAPTIVE  
140mm/150mm  
€ 259



VENTO ARGO 00  
140mm/150mm  
€ 299



VENTO ARGO R1  
140mm/150mm  
€ 199



VENTO ARGO R3  
140mm/150mm  
€ 149



VENTO ARGO R5  
140mm/150mm  
€ 109



TEMPO ARGO R1  
150mm/160mm  
€ 199



TEMPO ARGO R3  
150mm/160mm  
€ 149



TEMPO ARGO R5  
150mm/160mm  
€ 109



VENTO ANTARES 00  
140mm/150mm  
€ 299



VENTO ANTARES R1  
140mm/150mm  
€ 199



VENTO ANTARES R3  
140mm/150mm  
€ 149



VENTO ANTARES R5  
140mm/150mm  
€ 109



TEMPO ALIANTE R1  
145mm/155mm  
€ 199



TEMPO ALIANTE R3  
145mm/155mm  
€ 149



TEMPO ALIANTE R5  
145mm/155mm  
€ 109



ARIONE 00  
€ 299



ARIONE R1  
126mm/140mm  
€ 199



ARIONE R3  
126mm/140mm  
€ 149



ARIONE CLASSIC  
€ 129



ARIONE R1 OPEN  
132mm/142mm  
€ 199



ARIONE R3 OPEN (Black)  
132mm/142mm  
€ 149



ARIONE R3 OPEN (White)  
132mm/142mm  
€ 149

**TRIATHLON SADDLES**



TRANSIRO AERIS LD R1  
€ 199



TRANSIRO AERIS LD R3  
€ 149



TRANSIRO AERIS LD R5  
€ 109



TRANSIRO AERIS SD R1  
€ 199



TRANSIRO AERIS SD R3  
€ 149



TRANSIRO AERIS SD R5  
€ 109

**OFF-ROAD SADDLES**



VENTO ARGO X1  
140mm/150mm  
€ 199



VENTO ARGO X3  
140mm/150mm  
€ 149



VENTO ARGO X5  
140mm/150mm  
€ 109



TERRA ARGO X1  
140mm/150mm/160mm  
€ 199



TERRA ARGO X3  
140mm/150mm/160mm  
€ 149



TERRA ARGO X5  
140mm/150mm/160mm  
€ 109



TERRA ALPACA X5  
+ CARRIAGE KIT  
€ 109



GRAVITA ALPACA X5  
+ CARRIAGE KIT  
€ 99



TERRA AIDON X1  
145mm/160mm  
€ 179



TERRA AIDON X3  
145mm/160mm  
€ 139



TERRA AIDON X5  
145mm/160mm  
€ 89

ROAD SHOES



VENTO INFINITO KNIT  
CARBON 2  
Black/Black  
€ 380



VENTO INFINITO KNIT  
CARBON 2  
Coral/Black  
€ 380



VENTO INFINITO  
CARBON 2  
Black/Black  
€ 380



VENTO INFINITO  
CARBON 2  
White/Black  
€ 380



VENTO INFINITO  
CARBON 2  
Grey/Coral\*\*  
€ 380



NEW

VENTO POWERSTRAP  
AEROWEAVE CARBON  
White/White  
€ 350



NEW

VENTO POWERSTRAP  
AEROWEAVE CARBON  
Coral/Orange  
€ 350



TEMPO DECOS CARBON  
Aubergine  
€ 290



TEMPO DECOS CARBON  
Black/Black  
€ 290



TEMPO DECOS CARBON  
Iridescent Blue  
€ 290



TEMPO DECOS CARBON  
White/White  
Available also in WIDE version  
€ 290



VENTO OMNA  
Black/Black  
€ 165



VENTO OMNA  
White/Black  
Available also in WIDE version  
€ 165



VENTO OMNA  
Red/Black  
€ 165



VENTO OMNA  
Metallic Gun Metal/Black  
€ 165



VENTO OMNA  
Cherry/Black  
€ 165



TEMPO OVERCURVE R4  
White/Black  
€ 219



TEMPO OVERCURVE R4  
Navy/Black  
€ 219



TEMPO OVERCURVE R4  
Black/Black  
Available also in WIDE version  
€ 219



TEMPO OVERCURVE R4  
Copper/Black Iridescent  
€ 219



TEMPO OVERCURVE R4  
Beetle/Black Iridescent  
€ 219



TEMPO OVERCURVE R5  
Black/Black\*\*  
€ 119



TEMPO OVERCURVE R5  
White/Black\*\*  
€ 119



TEMPO OVERCURVE R5  
Black/Pink Fluo\*\*  
€ 119



TEMPO OVERCURVE R5  
Black/Yellow Fluo\*\*  
€ 119



TEMPO OVERCURVE R5  
Metallic Gun Metal/Black\*\*  
€ 119



TEMPO POWERSTRAP R5  
Black/Black  
€ 139



TEMPO POWERSTRAP R5  
White/Black  
€ 139



TEMPO POWERSTRAP R5  
Reflective Grey/Black  
€ 149

**ROAD SHOES**



TEMPO ARTICA R5 GTX  
Black/Black  
€ 259



TEMPO ARTICA R5 GTX  
White/Grey  
€ 259

**TRIATHLON SHOES**



TRANSIRO HYDRA  
AEROWEAVE CARBON  
White/Silver  
€ 290



TRANSIRO HYDRA  
AEROWEAVE CARBON  
White/Red-Blue  
€ 290



TRANSIRO HYDRA  
White/Black  
€ 149



TRANSIRO HYDRA  
White/Metallic Red  
€ 149



TRANSIRO HYDRA  
White/Metallic Blue  
€ 149

**OFF-ROAD SHOES**



VENTO FEROX CARBON  
Black/Black  
€ 299



VENTO FEROX CARBON  
Lilac/White  
€ 299



**NEW**

VENTO PROXY  
Black/Black  
€ 229



**NEW**

VENTO PROXY  
Coral/Purple  
€ 229



**NEW**

VENTO PROXY  
White/White  
€ 229



TERRA ATLAS  
Grey/Black  
€ 159



TERRA ATLAS  
Black/Black  
€ 159



TERRA ATLAS  
Army  
€ 159



TERRA ATLAS  
Pink Grape  
€ 159



TERRA ATLAS  
Black/Splash Purple  
Limited edition  
€ 159



TERRA ATLAS  
Green/Splash Pink  
Limited edition  
€ 159



VENTO OVERCURVE X3  
Black/Black\*\*  
€ 229



VENTO OVERCURVE X3  
White/Black\*\*  
€ 229

(\*\*) Fino ad esaurimento scorte | Jusqu'à épuisement des stocks

**OFF-ROAD SHOES**



TERRA POWERSTRAP X4  
Mud/Caramel  
**€ 159**



TERRA POWERSTRAP X4  
Black/Black  
**€ 159**



TERRA CLIMA X2  
Black/Black  
**€ 250**



TERRA ERGOLACE X2  
Teal Blue/Black  
**€ 129**



TERRA ERGOLACE X2  
Olive/Caramel  
**€ 129**



TERRA ERGOLACE X2  
Black/Black  
Available also in FLAT version  
**€ 129**



GRAVITA TENSOR  
Black/Black  
Available also in FLAT version  
**€ 179**



GRAVITA VERSOR  
Grey/Mud  
Available also in FLAT version  
**€ 139**

**GORE-TEX SHOES**



TERRA ERGOLACE X2 GTX  
Ice Grey/Black  
**€ 189**



TERRA ERGOLACE X2 GTX  
Anthracite/Black  
**€ 189**



TERRA ARTICA X5 GTX  
Black/Black  
**€ 259**



TERRA ARTICA X5 GTX  
Purple/Black  
**€ 259**

**VENTO MICROTEX TACKY BARTAPES** (Thickness 2mm)



Black € 40,90    White € 40,90    Red € 40,90    Orange Fluo € 40,90    Pink Fluo € 40,90    Yellow Fluo € 40,90    Lilla Fluo € 40,90    Celeste € 40,90

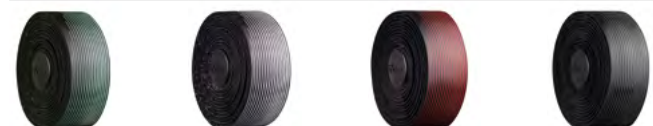

Black/Celeste € 43,90    Black/White € 43,90    Black/Red € 43,90    Black/Grey € 43,90

**VENTO SOLOCUSH TACKY BARTAPES** (Thickness 2,7mm)



Black € 43,90    White € 43,90    Blue € 43,90    Green € 43,90    Red € 43,90    Pink € 43,90    Yellow € 43,90    Orange Fluo € 43,90



Pink Fluo € 43,90    Yellow Fluo € 43,90    Lilla Fluo € 43,90    Celeste € 43,90    Mint Green € 43,90    Light Grey € 43,90    Dark Grey € 43,90

**TEMPO MICROTEX CLASSIC BARTAPES** (Thickness 2mm)



Black € 23,90    White € 23,90    Blue € 23,90    Green € 23,90    Red € 23,90    Pink € 23,90    Yellow € 23,90    Orange € 23,90



Honey € 23,90    Silver € 23,90    Celeste € 23,90

**TEMPO MICROTEX BOND CUSH BARTAPES** (Thickness 3mm)



Black € 30,90    White € 30,90    Honey € 30,90

**TEMPO MICROTEX BOND CUSH SOFT BARTAPE** (Thickness 3mm)



Black € 30,90    Red € 30,90

**TEMPO MICROTEX BOND CUSH TACKY BARTAPE - Les Classiques** (Thickness 3mm)



Le Classiques - Limited Edition € 43,90

**TERRA MICROTEX BOND CUSH TACKY BARTAPES** (Thickness 3mm)



Black € 43,90    White € 43,90    Red € 43,90    Dark Blue € 43,90    Green/Blue € 43,90    Brown € 43,90    Light Grey € 43,90

(\*\*) Fino ad esaurimento scorte | Jusqu'à épuisement des stocks





## MALLET PEDALS



MALLET DH 11  
Black/Gold  
€ 350



MALLET DH RACE  
Black/Black  
€ 180



MALLET DH RACE  
Red/Red  
€ 180



MALLET E 11  
Black/Gold  
€ 350



MALLET E  
Black/Black  
€ 180



MALLET E  
Electric Blue/Blue  
€ 180



MALLET E LS  
Blue/Black\*\*  
€ 180



MALLET E LS  
Silver/Black\*\*  
€ 180



MALLET E LS  
Lime Green/Black/Black\*\*  
Splatter edition  
€ 180



MALLET E LS  
Blue/Black/Black\*\*  
Splatter edition  
€ 180



MALLET TRAIL  
Black/Black  
€ 180



MALLET TRAIL  
Champagne/Black  
€ 180



MALLET TRAIL  
Purple/Black  
€ 180



MALLET 3  
Raw/Black/Blue  
€ 150



MALLET 3  
Raw/Red/Red\*\*  
€ 150



MALLET 2  
Raw/Green/Black\*\*  
€ 100



MALLET 2  
Raw/Silver/Black  
€ 100



## CANDY PEDALS



CANDY 11  
Gold/Gold  
€ 500



CANDY 7  
Black/Electric Blue/Black  
€ 180



CANDY 7  
Black/Black  
€ 180



CANDY 7  
Red/Red  
€ 180



CANDY 3  
Black/Black  
€ 150



CANDY 3  
Dark Red/Red\*\*  
€ 150



CANDY 3  
Slate Blue/Blue  
€ 150



CANDY 2  
Dark Grey/Black  
€ 100



CANDY 2  
Red/Black  
€ 100



CANDY 1  
Black/Black  
€ 60



CANDY 1  
Light Blue/Blue  
€ 60



CANDY 1  
Red/Red  
€ 60



CANDY 1  
Pink/Pink  
€ 60



## EGGBEATER PEDALS



EGGBEATER 11  
Gold/Gold  
€ 500



EGGBEATER 3  
Light Blue/Electric Blue  
€ 150



EGGBEATER 3  
Red/Red  
€ 150



EGGBEATER 3  
Black/Black  
€ 150



EGGBEATER 2  
Black/Black  
€ 100



EGGBEATER 2  
Black/Green  
€ 100



EGGBEATER 1  
Silver/Red  
€ 60



EGGBEATER 1  
Silver/Black  
€ 60

## DOUBLE SHOT PEDALS



DOUBLE SHOT 3  
Black/Black  
€ 150



DOUBLE SHOT 3  
Red/Black/Black  
€ 150



DOUBLE SHOT 2  
Black/Silver/Blue  
€ 100



DOUBLE SHOT 2  
Orange/Black/Orange  
€ 100



DOUBLE SHOT 2  
Blue/Black/Black  
€ 100



DOUBLE SHOT 1  
Black/Black  
€ 60



DOUBLE SHOT 1  
Blue/Black  
€ 60



DOUBLE SHOT 1  
Red/Black  
€ 60



## STAMP PEDALS



STAMP 11 - Small/Large  
Black/Gold  
€ 300



STAMP 7 - Small/Large  
Black  
€ 180



STAMP 7 - Small/Large  
Red  
€ 180



STAMP 7 - Small/Large  
Electric Blue  
€ 180



STAMP 7 - Small/Large  
High Polish Silver  
€ 190



STAMP 7 - Small/Large  
Lime Green\*\*  
Splatter edition  
€ 180



STAMP 7 - Small/Large  
Red\*\*  
Splatter edition  
€ 180



STAMP 7 - Small  
Blue\*\*  
Splatter edition  
€ 180



STAMP 3 - Small/Large  
Black Magnesium  
€ 140

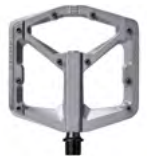

STAMP 3 - Small/Large  
Silver Magnesium  
€ 140



STAMP 2 - Small/Large  
Raw Silver  
€ 100



STAMP 2 - Small/Large  
Black  
€ 100



STAMP 1 - Small/Large  
Black  
€ 50



STAMP 1 - Small/Large  
Red  
€ 50



STAMP 1 - Small/Large  
Blue  
€ 50



STAMP 1 - Small/Large  
Orange  
€ 50



NEW

STAMP 1 GEN 2  
Small/Large  
Black  
€ 60



NEW

STAMP 1 GEN 2  
Small/Large  
Red  
€ 60



NEW

STAMP 1 GEN 2  
Small/Large  
Orange  
€ 60



NEW

STAMP 1 GEN 2  
Small/Large  
Navy Blue  
€ 60



NEW

STAMP 1 GEN 2  
Small/Large  
Purple  
€ 60

(\*\*) Fino ad esaurimento scorte | Jusqu'à épuisement des stocks



## MALLET TRAIL SHOES



NEW

MALLET TRAIL BOA  
Black/Gold  
€ 220



NEW

MALLET TRAIL LACE  
Black/Black  
€ 170



NEW

MALLET TRAIL LACE  
White/Purple  
€ 170



NEW

MALLET TRAIL LACE  
Blue/Blue  
€ 170

## STAMP TRAIL SHOES



NEW

STAMP TRAIL BOA  
Black/Gold  
€ 200



NEW

STAMP TRAIL LACE  
Black/Black  
€ 150



NEW

STAMP TRAIL LACE  
White/Purple  
€ 150



NEW

STAMP TRAIL LACE  
Blue/Blue  
€ 150

## MALLET SHOES



MALLET BOA  
Black/Gold  
€ 200



MALLET SPEEDLACE  
Black/White  
€ 170



MALLET LACE  
Black/Red  
€ 150



MALLET LACE  
Red/Black\*\*  
PumpForPeace edition  
€ 160



MALLET LACE  
Grey/Blue\*\*  
Splatter edition  
€ 150



MALLET LACE  
Petrol/Lime\*\*  
Splatter edition  
€ 150

## MALLET E SHOES



MALLET E BOA  
Black/Gold\*\*  
€ 200



MALLET E SPEEDLACE  
Green/Blue\*\*  
€ 170



MALLET E LACE  
Black/Blue\*\*  
€ 150

(\*\*) Fino ad esaurimento scorte | Jusqu'à épuisement des stocks



## STAMP SHOES



STAMP BOA  
Black/Gold  
€ 180



STAMP SPEEDLACE  
Black/White  
€ 150



STAMP SPEEDLACE  
Purple/Teal Blue  
€ 150



STAMP SPEEDLACE  
Green/Orange\*\*  
€ 150



STAMP SPEEDLACE  
Grey/Red\*\*\*  
€ 150



STAMP LACE  
Black/Silver  
€ 130



STAMP LACE  
White/White  
€ 130



STAMP LACE  
Navy/Silver  
€ 130



STAMP LACE  
Red/Black\*\*  
PumpForPeace edition  
€ 140



STAMP LACE  
Grey/Blue\*\*  
Splatter edition  
€ 130



STAMP LACE  
Petrol/Lime\*\*  
Splatter edition  
€ 130

## STAMP STREET SHOES



STAMP STREET LACE  
Black/Gold  
€ 130



STAMP STREET LACE  
White/Gold  
€ 130

## CANDY GRAVEL/XC SHOES



CANDY GRAVEL / XC LACE  
Black/Black  
€ 160



CANDY GRAVEL / XC LACE  
White/Grey  
€ 160

(\*\*) Fino ad esaurimento scorte | Jusqu'à épuisement des stocks



## ALLOY WHEELS



SYNTHESIS XCT ALLOY  
Alloy Single Wheel  
€ 240 front / € 360 rear

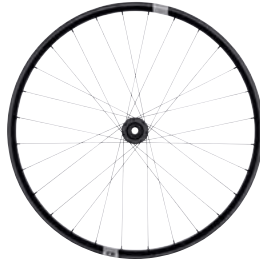

SYNTHESIS E ALLOY  
Alloy Single Wheel  
€ 240 front / € 360 rear



SYNTHESIS E-BIKE ALLOY  
Alloy Single Wheel  
€ 300 front / € 400 rear



NEW

SYNTHESIS GRAVEL  
Alloy Single Wheel  
€ 240 front / € 360 rear



COBALT 2  
Alloy Wheelsets  
€ 600



IODINE 2  
Alloy Wheelsets  
€ 600



ZINC 3  
Alloy Wheelsets  
€ 800

## CARBON WHEELS



SYNTHESIS XCT 11  
Carbon Wheelsets  
€ 2.400



SYNTHESIS E 11  
Carbon Wheelsets  
€ 2.400



NEW

SYNTHESIS GRAVEL  
Carbon Single Wheel  
€ 600 front / € 900 rear

## GRIPS



COBALT  
Silver  
€ 30



COBALT  
Gold  
€ 30



COBALT  
Red  
€ 30



IODINE  
Black  
€ 30



---

## DROPPER SEATPOST

---



HIGHLINE 11  
100/125/150/170 mm  
**€ 400**

---



HIGHLINE 7  
100/125/150/170/200 mm  
**€ 300**

---



HIGHLINE 3  
80/100/125/150/170/200 mm  
**€ 200**

---



HIGHLINE XC/GRAVEL  
60/80/100/125 mm  
**€ 250**

---



## CAMBIUM SADDLES



C13 145mm/158mm  
Black  
€ 200



C13 Carved 145mm/158mm  
Black  
€ 200



C15  
Black  
€ 130



C15 Carved  
Black  
€ 130



C17  
Black  
€ 130



C17 Colored Top  
Brown  
€ 130



C17 Colored Top  
Mud Green  
€ 130



C17 Colored Top  
Bronze Orange  
€ 130



C17 Colored Top  
Octane  
€ 130



C17 Carved  
Black  
€ 130



C17 Carved Colored Top  
Brown  
€ 130



C17 Carved Colored Top  
Mud Green  
€ 130



C17 Carved Colored Top  
Bronze Orange  
€ 130



C17 Carved Colored Top  
Octane  
€ 130



C17 Special Organic Cotton  
Black/Natural Rubber  
€ 160



C17 Special Organic Cotton  
Black/Black Rubber  
with Copper Rivets  
€ 160

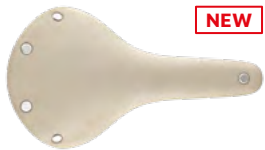

C17 Special Organic Cotton  
Natural/Natural Rubber  
€ 160



C19  
Black  
€ 130



C19 Carved  
Black  
€ 130



C67  
Black  
€ 130

**LEATHER SADDLES**



SWIFT  
Black  
€ 190



SWIFT  
Honey  
€ 190



SWIFT  
Antique Brown  
€ 190



SWALLOW  
Black  
€ 190



SWALLOW  
Honey  
€ 190



SWALLOW  
Antique Brown  
€ 190



B17 Narrow  
Black  
€ 150



B17 Narrow  
Honey  
€ 150



B17 Narrow  
Antique Brown  
€ 150



B17  
Black  
€ 150



B17  
Honey  
€ 150



B17  
Antique Brown  
€ 150



B17 Short  
Black  
€ 150



B17 Short  
Honey  
€ 150



B17 Short  
Antique Brown  
€ 150



B17 Carved  
Black  
€ 150



B17 Carved  
Honey  
€ 150



B17 Carved  
Antique Brown  
€ 150



B17 Softened  
Dark Tan  
€ 150

**LEATHER SADDLES**



B17 Special  
Black  
€ 190



B17 Special  
Honey  
€ 190



B17 Special  
Antique Brown  
€ 190



B17 Special Titanium  
Black  
€ 260



FLYER  
Black  
€ 160



FLYER  
Honey  
€ 160



FLYER  
Antique Brown  
€ 160



FLYER Short  
Black  
€ 160



FLYER Short  
Honey  
€ 160

**NEW**



FLYER Short  
Antique Brown  
€ 160

**NEW**



FLYER Carved  
Black  
€ 160



FLYER Carved  
Honey  
€ 160



FLYER Carved  
Antique Brown  
€ 160



FLYER Softened  
Dark Tan  
€ 160



B33  
Black  
€ 230



B33  
Honey  
€ 230

**LEATHER SADDLES**



B66  
Black  
€ 180



B66  
Honey  
€ 180



B66  
Antique Brown  
€ 180



B66 Short  
Black  
€ 180

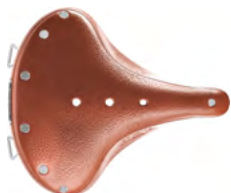

B66 Short  
Honey  
€ 180



B66 Short  
Antique Brown  
€ 180



B67  
Black  
€ 160



B67  
Honey  
€ 160



B67  
Antique Brown  
€ 160



B67 Short  
Black  
€ 160



B67 Short  
Honey  
€ 160



B67 Short  
Antique Brown  
€ 160



**NEW**

B68  
Black  
€ 160



**NEW**

B68  
Honey  
€ 160



**NEW**

B68  
Antique Brown  
€ 160



**NEW**

B72  
Black  
€ 180



**NEW**

B72  
Antique Brown  
€ 180

## ERGONOMIC RUBBER GRIPS



130/130 mm  
Black  
€ 60



130/100 mm  
Black  
€ 60



100/100 mm  
Black  
€ 60

## CAMBIUM RUBBER GRIPS



130/130 mm  
Black  
€ 45



130/100 mm  
Black  
€ 45



130/130 mm  
Natural  
€ 45



130/100 mm  
Natural  
€ 45

## CAMBIUM RUBBER BAR TAPE



Textured 3mm  
Comfort Padding  
Black  
€ 45



Textured 3mm  
Comfort Padding  
Natural/Rubber  
€ 45



Textured 3mm  
Comfort Padding  
Brown  
€ 45



Textured 3mm  
Comfort Padding  
Mud Green  
€ 45



Textured 3mm  
Comfort Padding  
Bronze Orange  
€ 45



Textured 3mm  
Comfort Padding  
Octane  
€ 45

## SLENDER LEATHER GRIPS



130/130 mm  
Black  
€ 90



130/100 mm  
Black  
€ 90



100/100 mm  
Black  
€ 90



130/130 mm  
Honey  
€ 90



130/100 mm  
Honey  
€ 90



100/100 mm  
Honey  
€ 90



130/130 mm  
Antique Brown  
€ 90



130/130 mm  
Dark Tan  
€ 90

## LEATHER BAR TAPE



Perforated  
Leather Tape  
Black  
€ 70



Perforated  
Leather Tape  
Honey  
€ 70



Perforated  
Leather Tape  
Antique Brown  
€ 70

## MICROFIBER BAR TAPE



3mm  
Comfort Padding  
Black  
€ 35



3mm  
Comfort Padding  
Honey  
€ 35



3mm  
Comfort Padding  
Antique Brown  
€ 35

**BIKE BAGS**



CHALLENGE SADDLE BAG  
Black  
€ 115



CHALLENGE SADDLE BAG  
Honey  
€ 115



CHALLENGE SADDLE BAG  
Antique Brown  
€ 115



CHALLENGE SADDLE BAG  
Dark Tan  
€ 115

**SCAPE BAGS - HANDLEBAR BAGS**



HANDLEBAR CASE  
8L - Mud Green  
€ 140



FEED POUCH  
1,2L - Mud Green  
€ 50



FEED POUCH  
1,2L - Black  
€ 50



HANDLEBAR POUCH  
3L - Mud Green  
€ 70



HANDLEBAR POUCH  
3L - Black  
€ 70



HANDLEBAR COMPACT  
BAG 10L - Mud Green  
€ 120



HANDLEBAR ROLL  
10/12L - Mud Green  
€ 140



HANDLEBAR ROLL  
10/12L - Black  
€ 140

**SCAPE BAGS - SADDLE BAGS**



SEAT BAG  
8/10L - Mud Green  
€ 140



SEAT BAG  
8/10L - Black  
€ 140



SADDLE POCKET BAG  
0,7L - Mud Green  
€ 50



SADDLE POCKET BAG  
0,7L - Black  
€ 50



SADDLE ROLL BAG  
1L - Mud Green  
€ 50

**SCAPE BAGS - PANNIERS**



SMALL PANNIER  
10/13L - Mud Green  
€ 120



SMALL PANNIER  
10/13L - Black  
€ 120



LARGE PANNIER  
18/22L - Mud Green  
€ 125



LARGE PANNIER  
18/22L - Black  
€ 125

## SCAPE BAGS - FRAME BAGS



FULL FRAME  
5,5L - Mud Green  
€ 120



FULL FRAME  
5,5L - Black  
€ 120



FRAME BAG  
3L - Mud Green  
€ 95



FRAME BAG  
3L - Black  
€ 95



FRAME BAG LARGE  
3,5L - Mud Green  
€ 100



FRAME BAG LARGE  
3,5L - Black  
€ 100



LONG TOP TUBE BAG  
1,5L - Mud Green  
€ 65



LONG TOP TUBE BAG  
1,5L - Black  
€ 65



TOP TUBE BAG  
0,9L - Mud Green  
€ 55  
€ 65 with bolts



TOP TUBE BAG  
0,9L - Black  
€ 55  
€ 65 with bolts

## PICKWICK BACKPACK 12L



PICKWICK  
COTTON CANVAS  
12L - Total Black  
€ 220



PICKWICK  
COTTON CANVAS  
12L - Grey/Honey  
€ 220



PICKWICK  
COTTON CANVAS  
12L - Sage Green/Honey  
€ 220



PICKWICK  
COTTON CANVAS  
12L - Dark Blue/Black  
€ 220



PICKWICK  
COTTON CANVAS  
12L - Goose Beak/Maroon  
€ 220



NEW

PICKWICK  
COTTON CANVAS  
12L - Forest  
€ 220

**PICKWICK BACKPACK 26L**



PICKWICK  
COTTON CANVAS  
26L - Total Black  
**€ 250**



PICKWICK  
COTTON CANVAS  
26L - Grey/Honey  
**€ 250**



PICKWICK  
COTTON CANVAS  
26L - Forest  
**€ 250**



PICKWICK  
COTTON CANVAS  
26L - Dark Blue/Black  
**€ 250**



PICKWICK  
COTTON CANVAS  
26L - Goose Beak/Maroon  
**€ 250**

**NEW**



**NEW**

PICKWICK  
COTTON CANVAS  
26L - Sage Green/Honey  
**€ 250**

**BASKET**



HOXTON BASKET  
25L - Aluminium  
**€ 190**

**PANNIERS**



BRICKLANE  
ROLL-UP PANNIERS  
15L - Grey/Honey  
**€ 200**



BRICKLANE  
ROLL-UP PANNIERS  
15L - Sage Green/Honey  
**€ 200**



BRICKLANE  
ROLL-UP PANNIERS  
15L - Goosebeak/Maroon  
**€ 200**



## ROAD RANGE



ELEMENTO  
White  
€ 375



ELEMENTO  
Black  
€ 375



UTOPIA Y  
White  
€ 275



UTOPIA Y  
Black  
€ 275



PROTONE ICON  
Black  
€ 275



PROTONE ICON  
White  
€ 275



PROTONE ICON  
Grey  
€ 275



PROTONE ICON  
Light Blue  
€ 275



PROTONE ICON  
Red  
€ 275



PROTONE ICON  
Tangerine MATT  
€ 275

NEW



PROTONE ICON  
Sahara MATT  
€ 275

NEW



PROTONE ICON  
Black MATT  
€ 275



PROTONE ICON  
White MATT  
€ 275



PROTONE ICON  
Grey MATT  
€ 275



PROTONE ICON  
Blue MATT  
€ 275



PROTONE ICON  
Olive Green MATT\*\*  
€ 275



VALEGRO  
Black  
€ 209



VALEGRO  
White  
€ 209



VALEGRO  
Black MATT  
€ 209

**ROAD RANGE**



MOJITO<sup>3</sup>  
White  
€ 149



MOJITO<sup>3</sup>  
Black  
€ 149



MOJITO<sup>3</sup>  
Grey  
€ 149



MOJITO<sup>3</sup>  
Yellow Fluo  
€ 149



MOJITO<sup>3</sup>  
Orange Fluo  
€ 149



MOJITO<sup>3</sup>  
Bicolor White/Black  
€ 149



MOJITO<sup>3</sup>  
Bicolor Black/Red  
€ 149



MOJITO<sup>3</sup>  
Bicolor White/Red  
€ 149



MOJITO<sup>3</sup>  
Bicolor Grey/Black  
€ 149



MOJITO<sup>3</sup>  
Black MATT  
€ 149



MOJITO<sup>3</sup>  
White MATT\*\*  
€ 149



MOJITO<sup>3</sup>  
Grey MATT\*\*  
€ 149



MOJITO<sup>3</sup>  
Olive Green MATT\*\*  
€ 149



SINTESI  
White  
€ 100



SINTESI  
Black  
€ 100



SINTESI  
Red  
€ 100



SINTESI  
Grey  
€ 100



SINTESI  
Sahara  
€ 100



WASABI  
Black MATT  
€ 300



WASABI  
White MATT  
€ 300

## MTB RANGE

---



REX  
Black  
€ 229



CAIPI  
Black  
€ 139



CAIPI  
White  
€ 139

## AERO RANGE

---



MISTRAL  
Black/Anthracite + Clear Visor  
€ 349



BAMBINO PRO  
Black Matt + Clear Visor  
€ 349

## URBAN RANGE

---



MOEBIUS  
Onix MATT  
€ 99



MOEBIUS  
Ivory MATT  
€ 99



























MOEBIUS  
Champagne MATT  
€ 99



MOEBIUS  
Ash MATT  
€ 99

## EYEWEAR

 ALIBI White MATT/Photochromic € 220	 ALIBI Orange MATT/Green MR € 180	 ALIBI Grey MATT/Turquoise MR € 180	 ALIBI Black MATT/Gold MR € 180		
 SUPERNOVA Black MATT/Photochromic € 210	 SUPERNOVA Black MATT/Green MR € 179	 SUPERNOVA Yellow Fluo/Red MR € 179	 SUPERNOVA White/Turquoise MR € 179	 SUPERNOVA White/Red MR € 179	
 NOVA Black MATT/Fuchsia MR € 179	 NOVA Olive Green MATT/Orange MR € 179				
 DEMOS White/Photochromic € 190	 DEMOS White/Turquoise MR € 159	 DEMOS White/Brown € 159	 DEMOS Black/Green MR € 159	 DEMOS Blue/ Turquoise MR € 159	
 DEMOS Glass/Red MR € 159	 DEMOS Black MATT /Red MR € 180				
 SPECTRO Black/Photochromic € 200	 SPECTRO Whiet/Green MR € 179	 SPECTRO Black/Red MR € 179			
 COSMO Black MATT/Polarized € 150	 DEMOS Blonde/Classic Green € 120	 DEMOS Crystal/Violet MR € 120			

# A4 SALES AGENTS

## ITALIA

LOMBARDIA / PIEMONTE / VALLE D'AOSTA / LIGURIA

**Lorenzo Galimberti**

M +39 335 8178672

T +39 02 49469659

l.galimberti@libero.it

info@galimbertirappresentanze.it

VENETO / TRENTO ALTO ADIGE / FRIULI VENEZIA GIULIA

**Alberto Buratti**

M +39 320 3159551

alberto.buratti@gmail.com

**Emiliano Donadello**

M +39 347 4145501

donadelloemiliano@gmail.com

EMILIA ROMAGNA / MARCHE

**Luca Molinari**

M +39 347 2912879

lucamolinari1979@gmail.com

TOSCANA / UMBRIA

**Marco Mazzoni**

M +39 393 9889394

marco.mazzoni2@gmail.com

LAZIO / ABRUZZO / MOLISE

**Roberto Capomaggi**

M +39 348 6513270

robcapomaggi@yahoo.it

CAMPANIA / PUGLIA / BASILICATA / CALABRIA

**Pasquale Pegna**

M +39 339 2058455

pegna77@gmail.com

SICILIA

**Giuseppe Calvaruso**

M +39 388 3480893

giuseppecalvaruso1@gmail.com

SARDEGNA

**Stefano Mocci**

M +39 392 7427909

rappresentanze.stefanomocci@gmail.com

**SALES AREA MANAGER**

**Andrea Molteni**

M +39 3666211240

andrea.molteni@selleroyalgroup.com

**COPYRIGHT.** Tutti i contenuti del presente catalogo, inclusi testi, documenti, loghi, immagini, grafici, video, la loro stessa disposizione e adattamento all'interno del sito, sono tutelati dalle leggi sul Copyright© di Selle Royal Group S.p.A. e dagli altri diritti di proprietà intellettuale. La riproduzione, alterazione, modifica, pubblicazione e uso, anche parziale, di questi contenuti per qualsiasi scopo, sia esso commerciale o meno, in qualsiasi formato e supporto, non sono permessi senza l'espressa autorizzazione scritta da parte di Selle Royal Group S.p.A. Tutti i diritti sono riservati.

**MARCHI.** Tutti i marchi e i loghi presenti nel catalogo sono proprietà esclusiva dei rispettivi titolari. Qualsiasi uso e/o riproduzione degli stessi per qualunque scopo o mezzo è espressamente e severamente vietato e verrà perseguito dalle leggi competenti in materia.

**LIMITI DI RESPONSABILITÀ.** I contenuti e le informazioni presenti nel catalogo sono fornite "così come sono" e periodicamente aggiornate e controllate. Conseguentemente, potrebbero non risultare complete, accurate o aggiornate in ogni momento, o contenere degli errori. Selle Royal Group S.p.A. declina ogni responsabilità ed ogni garanzia riguardante la completezza, l'aggiornamento, errori ed omissioni delle informazioni e dei contenuti presenti nel catalogo.



#### **SEDE LEGALE/OPERATIVA**

Selle Royal Group S.p.A.  
Via Vittorio Emanuele 119  
36050 Pozzoleone (VI) Italy

#### **CONTATTI**

T +39 0444 461100  
T +39 0444 461102  
info@a4selection.com  
www.a4selection.com

#### **RECLAMI E RESI**

info@a4selection.com  
(per ricevere autorizzazione al reso e relative istruzioni)

#### **SERVIZIO ASSISTENZA CRANKBROTHERS ITALIA**

Pippo Wheels S.r.l.  
Via S. Venier 15  
36100 Vicenza (VI) Italy  
T +39 0444 532052  
crankbrothers@pippowheels.com

#### **GARANZIA**

Gli articoli presenti in questo catalogo sono coperti da garanzia di **2 ANNI** dalla data di acquisto

**Selle Royal**

SELLEROYAL.COM

**fi'zi:k**

FIZIK.COM



crankbrothers

CRANKBROTHERS.COM

**Continental** 

CONTINENTAL-TIRES.COM

**BROOKS**  
18 ENGLAND 66

BROOKSENGLAND.COM

**KASK**

KASK.COM

**KCO**  
e y e w e a r

KOOWORLD.CC



**A4SELECTION.COM**

