



AAA

SELECTION

WORKBOOK 2019

SELECTION DE NOS MEILLEURS
COMPOSANTS POUR LE VELO



PEDAL ED

fi'zi:k



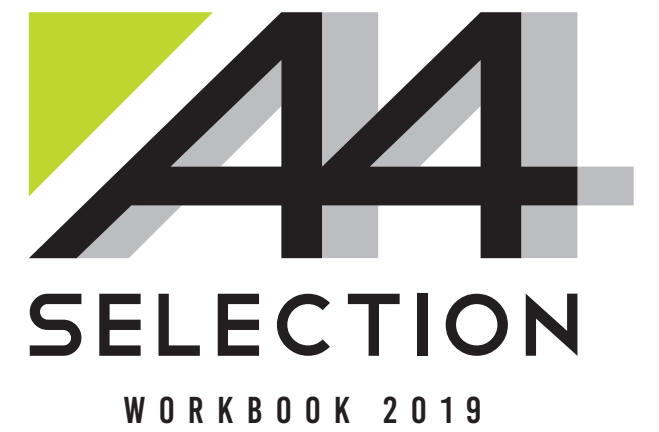

A4
SELECTION
WORKBOOK 2019

SELLE ROYAL 2
PEDALED 46
FI'ZI:K 110
CRANKBROTHERS 180
CONTINENTAL 240
NAMEDSPORT 288



SELLE ROYAL **SCIENTIA FOR CYCLISTS**

Un range di selle sviluppate scientificamente in collaborazione con l'Università di Colonia.

Une gamme de selles développée scientifiquement en collaboration avec l'Université de Cologne.

Page 4

SELLE ROYAL **COMFORT FOR CYCLISTS**

Un range di selle per tutti gli utilizzi e stili di guida, da Athletic a Relaxed.

Une gamme de selles pour tous types d'utilisation et de style de pratiques, de l' Athletic au Relaxed

Page 14

SELLE ROYAL SCIENTIA FOR CYCLISTS

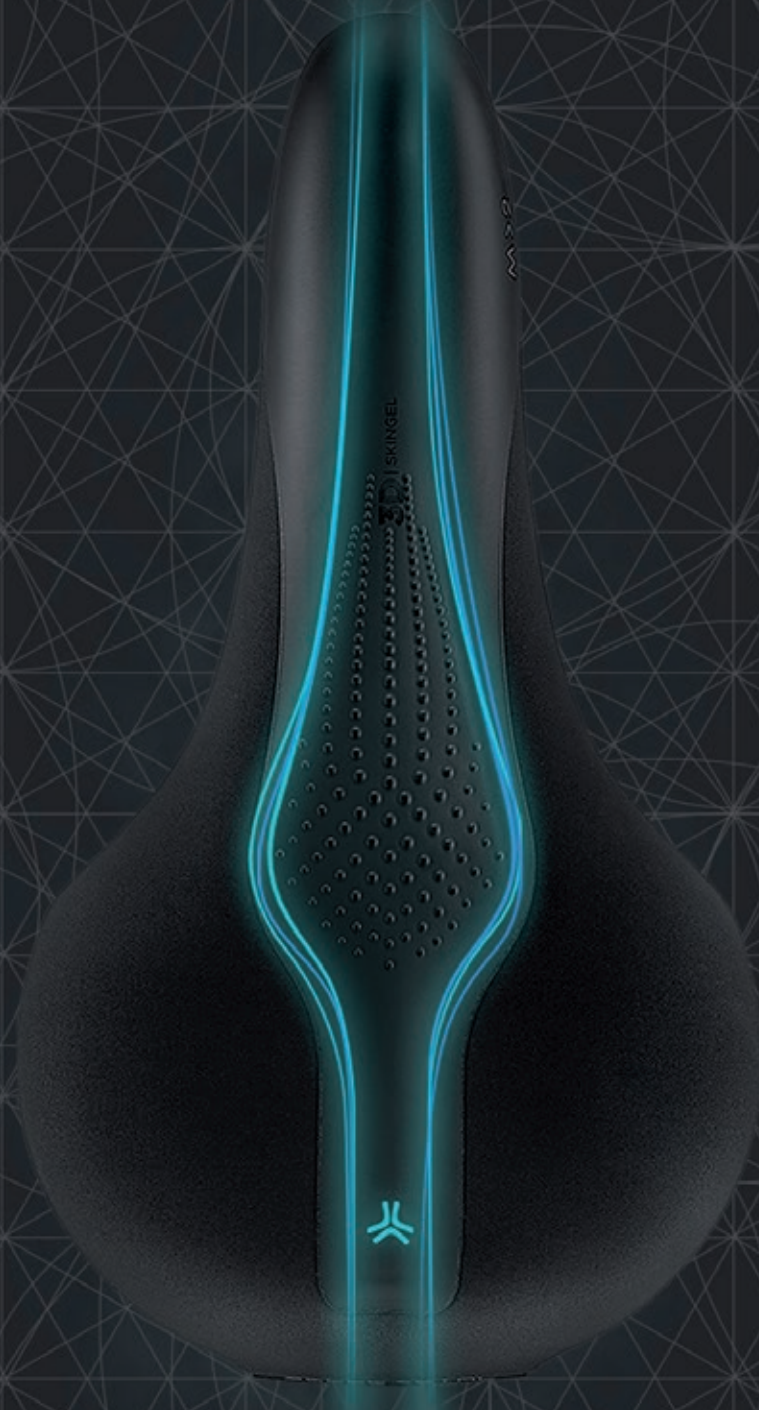

Scientificamente sviuppato in collaborazione con / Développé scientifiquement en collaboration avec



**Deutsche
Sporthochschule Köln**
German Sport University Cologne

SCIENTIA CARATTERISTICHE | CARACTÉRISTIQUES

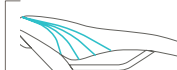

BODY CONTOUR | CONTOUR DU CORPS

Design dei bordi con raggio specifico per fornire un comfort ottimale per le diverse inclinazioni del ciclista. Maggiore è l'inclinazione della posizione di guida, minore è il raggio dei bordi.

Un profil conçu par rapport au rayon, optimisant le confort du cycliste en fonction de l'inclinaison de sa colonne vertébrale. Plus la position est inclinée, plus petit est le rayon.



REAR PLATEAU | PLATEAU ARRIÈRE

Una parte posteriore rialzata impedisce di arretrare con la posizione in sella e riduce la pressione al centro, in corrispondenza della zona perineale, garantendo così il comfort desiderato.

La partie arrière de la coque est surélevée afin d'éviter le glissement vers l'arrière de l'utilisateur et diminuer ainsi la pression sur le milieu de la selle, soulageant la zone périnéale et améliorant ainsi le confort.

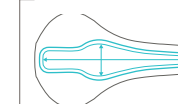

CANALE CENTRALE | CANAL CENTRAL

Canale centrale scavato: forma e dimensioni sono stati studiati per corrispondere alla distanza delle ossa ischiatiche per garantire un maggiore comfort.

La partie centrale de la selle présente un creu correspondant à la forme et à l'espace entre les ischions afin de garantir le meilleur confort.

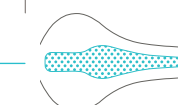
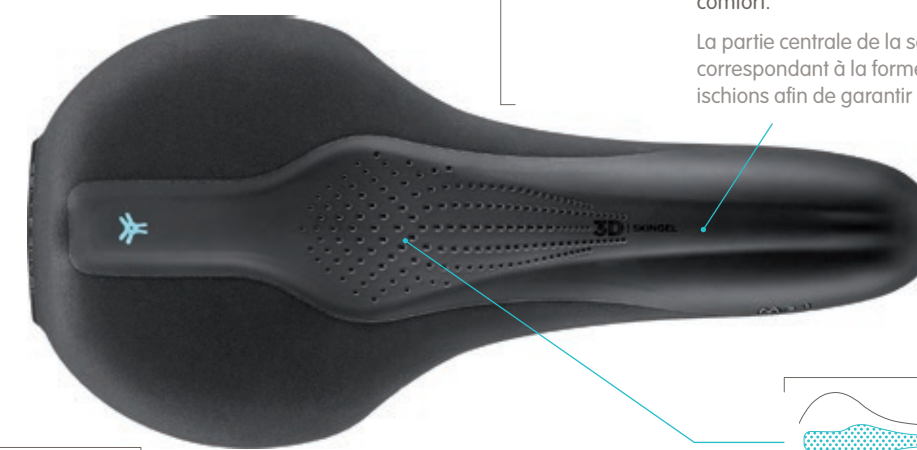

3D SKINGEL

Royalgel™ è sapientemente posizionato in corrispondenza dei punti di contatto critici della superficie della sella, ovvero la zona di contatto dei tessuti molli, per un maggiore assorbimento degli urti.

Le Royalgel™ est positionné au niveau des divers emplacements critiques qui correspondent aux point de contact avec les tissus mous, dans le but d'absorber le moindre choc.



CURVA SUSPENSION SYSTEME D'AMORTISSEMENT CURVA

Questo esclusivo sistema di sospensione è fissato alla parte posteriore dello scafo, per offrire un comfort esclusivo evitando la pressione sui punti di contatto delle ossa ischiatiche, garantendo così una maggiore flessibilità laterale.

Ce système d'amortissement unique, est fixé sur la partie arrière de la coque. Il procure un niveau de confort optimal en éliminant la pression due au contact des ischions sur la coque, garantissant une flexibilité latérale plus importante.



1 TROVA LA TUA POSIZIONE DI GUIDA SÉLECTIONNER LA POSITION DE PEDALAGE SOUHAITEE

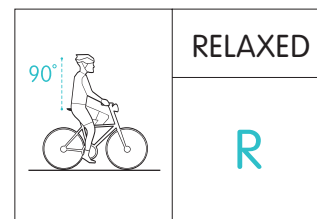
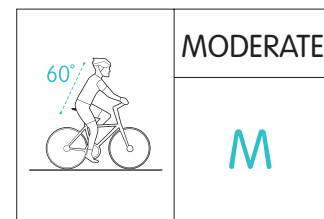
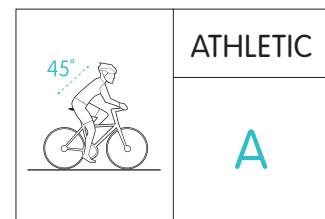

2 DETERMINA LA DISTANZA TRA LE OSSA ISCHIATICHE DETERMINER LA LARGEUR ENTRE LES ISCHIIONS

Ripristinare lo stato di partenza del cuscinetto gel.
Réinitialisation du coussin gel.

Sedersi a 90° e tirare le impugnature laterali per esercitare pressione sulla superficie dello sgabello.
S'asseoir à 90 degrés et tirer sur les poignées afin d'augmenter la pression sur le tabouret.

Individuare i centri delle due impronte delle ossa ischiatiche e aggiungere i due numeri.
Trouver le centre de l'empreinte de chaque os d'assise sur le tabouret et ajouter les deux chiffres correspondants.

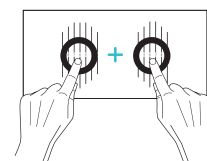
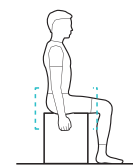

esempio/esemple:
5cm+7cm=12cm

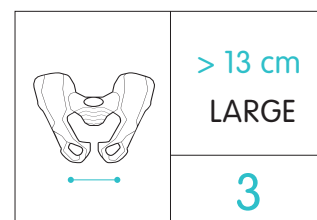
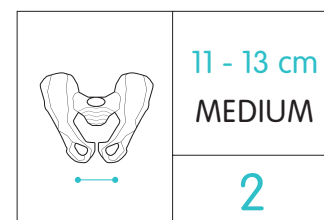
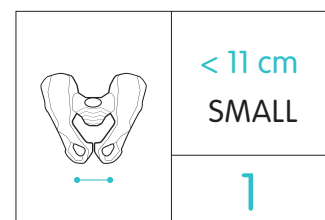

	1 SMALL	2 MEDIUM	3 LARGE
ATHLETIC A	 A>1	 A>2	 A>3
MODERATE M	 M>1	 M>2	 M>3
RELAXED R	 R>1	 R>2	 R>3

SCIENTIA A1 / SMALL
code 54A0SB0A09210
sizes L 289 mm / W 127 mm / W 380 g
price € 79,90

UNISEX



A>1

SCIENTIA A2 / MEDIUM
code 54A0MB0A09210
sizes L 289 mm / W 144 mm / W 390 g
price € 79,90

UNISEX



A>2

SCIENTIA A3 / LARGE
code 54A0LB0A09210
sizes L 289 mm / W 159 mm / W 415 g
price € 79,90

UNISEX



A>3

SCIENTIA M1 / SMALL
code 54M0SB0A09210
sizes L 289 mm / W 141 mm / W 425 g
price € 79,90

UNISEX



M>1

SCIENTIA M2 / MEDIUM
code 54M0MB0A09210
sizes L 289 mm / W 161 mm / W 455 g
price € 79,90

UNISEX



M>2

SCIENTIA M3 / LARGE
code 54M0LB0A09210
sizes L 289 mm / W 178 mm / W 465 g
price € 79,90

UNISEX



M>3

SCIENTIA TESTED ON THOUSANDS, DESIGNED ON YOU.

SCIENTIA R1 / SMALL

code 54R0SB0A09210

sizes L 289 mm / W 169 mm / W 479 g

price € 79,90

UNISEX



R>1

SCIENTIA R2 / MEDIUM

code 54R0MB0A09210

sizes L 289 mm / W 196 mm / W 485 g

price € 79,90

UNISEX



R>2

SCIENTIA R3 / LARGE

code 54R0LB0A09210

sizes L 289 mm / W 224 mm / W 520 g

price € 79,90

UNISEX



R>3



in collaboration with



POP MATERIALS

MEASURING TOOLS

(venduto separatamente)
(Vendu séparément)

MEASURING TOOL STANDARD

Sgabello in metallo di alta qualità con cuscino in gel.
Tabouret en métal de haute qualité avec coussin en gel.

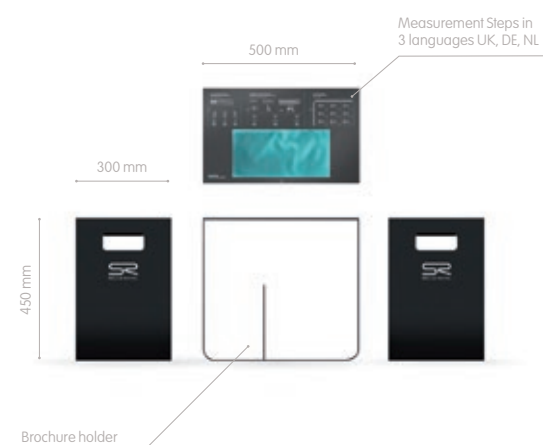

CODE: SRSIMTOA00000

PORTABLE MEASURING TOOL

Strumento di misurazione ultra leggero con cuscino in gel.
Outil de mesure ultra léger en PS, avec gel pad intégré.



CODE: SRSIMTOA10000

ADVANCED KIT SLIM

NEW

Display compatto in MDF e Dibond®, pre-caricato di 9 selle, 1 per ogni modello.

+ 9 selle per la vendita, 1 per ogni modello. + Strumento di misurazione ossa ischiatiche incluso (Portable Measuring Tool).

Présentoir compact en MDF et Dibond, pré rempli de 9 selles prêtes à la vente, 1 de chaque modèle.

+ 9 selles de réassort, 1 de chaque modèle. + outil de mesure (Portable Measuring Tool).



CODE: SRSIADVA10000

POP MATERIALS

ADVANCED KIT

Display in metallo precaricato con 27 selle, 3 per ogni modello, pronte per essere vendute. + Measuring Tool standard.
Présentoir en métal prédisposé pour 27 selles, 3 par modèle, prêtes à la vente. + Measuring Tool standard.



CODE: SRSIADVA00000

FLEX KIT

(Unità di vendita: 2 moduli)
(unités de vente: 2 module)

EACH MODULE

Struttura in plastica con ganci in metallo compatibili con slatwall/ tegometall, già precaricata di 6 selle, 2 per ogni modello.

> Measuring Tools venduto separatamente.

Structure en plastique avec crochets métalliques compatibles slatwall/ tegometall, pré-chargée par 6 selles, 2 par modèle.

> Measuring Tools vendu séparément.



Order each module individually
from among these codes:

Athletic Module
CODE: SRSIATHA00000

Moderate Module
CODE: SRSIMODA00000

Relaxed Module
CODE: SRSIRELA00000

SELLE ROYAL COMFORT FOR CYCLISTS

Selle Royal, per garantire il massimo comfort per ogni stile e posizione di guida della bicicletta, ha introdotto tre categorie di selle specifiche: Athletic, Moderate e Relaxed. La posizione di guida, infatti, influenza per la maggior parte il modo in cui le ossa del bacino e le zone genitali vanno a contatto con la sella. È a questi punti di contatto che bisogna fare attenzione con un design specifico della sella.

Afin de garantir un confort maximum à tout type de cycliste et de pédalage, Selle Royal a classé les utilisateurs en 3 catégories, par rapport à différentes positions: Athlétique (Athletic) - Modérée (Moderate) - et Détendue (Relaxed). En effet, la position influence naturellement la façon dont les ischiens sont en contact avec la selle. Ces points de contact doivent conditionner la conception et la spécificité même de la selle.

RIDING POSITIONS

ATHLETIC 45°

Il ciclista Athletic prevede un'inclinazione sulla bicicletta di 45 gradi. Questa posizione fa sì che le ossa del bacino siano posizionate nella parte anteriore della sella.

Chez le cycliste de type Athlétique, l'inclinaison du buste est de 45°. Cette position déplace la distribution du poids ainsi que la zone des ischiens vers l'arrière de la selle.



MODERATE 60°

Il ciclista Moderate siede con un'inclinazione di 60 gradi. Questa posizione sposta verso il retro della sella il peso del ciclista e la sua seduta.

Chez le cycliste de type Modéré, l'inclinaison du buste est généralement de 60°. Cette position déplace le poids du cycliste et les ischiens un peu plus en arrière, sur une selle plus large.



RELAXED 90°

Il ciclista Relaxed guida con una posizione eretta con angolatura di 90 gradi. Questa posizione sposta oltre il 60% del peso del ciclista sul retro della sella.

Le cycliste de type Détendu est généralement assis en position dos vertical, formant un angle de 90°. Cette position place plus de 60% du poids du cycliste directement sur l'arrière de la selle.



5 DIVERSE LINEE PER DIFFERENTI CICLISTI 5 LIGNES POUR DIFFERENTS TYPES DE PRATIQUANTS:

ezone

eZONE unisce Acceleration Control, eFit Design e speciali funzioni per un miglior comfort, una maggiore sicurezza e controllo per i ciclisti eBike.

eZONE associe la technologie Acceleration Control au eFit Design ainsi que d'autres caractéristiques particulières afin d'améliorer le confort, la sécurité et le contrôle des utilisateurs d'eBikes.



respiro

Se si lascia la bici sotto il calore del sole, la temperatura della sella può aumentare ad un livello spiacevole. Per evitare una cattiva traspirazione e una sensazione di disagio, è stata sviluppata la linea Respiro, progettata con un canale di ventilazione e uno speciale materiale per la copertina che riducono il calore sulla sella.

Respiro est notre modèle haut de gamme. Son canal de ventilation central vous permet de rester au frais deux fois plus longtemps qu'une selle ordinaire et sa forme ergonomique unique réduit la pression pour plus de confort.



LOOKIN

La linea Lookin combina un design innovativo al valore del Royalgel™, il gel poliuretano è visibile attraverso le finestre sulla copertina e riduce del 40% i picchi di pressione.

La ligne Lookin associe un design innovant aux qualités du gel Royalgel™. Ce gel de polyuréthane est visible sur la couverture à travers des fenêtres transparentes. Il réduit de 40% les pics de pression.



Premium

Il massimo comfort, per ogni gusto. Le selle della linea Premium sono realizzate utilizzando la tecnologia Royal Vacuum Light che permette alle selle di essere al 100% sigillate e il 20% più leggere.

Un confort maximal pour tous types de cyclistes. Les selles Premium sont fabriquées à l'aide de notre système novateur Royal Vacuum Clair (RVL), qui les rend 100% étanches et 20% plus légères. Différents modèles sont disponibles pour tout type de bicyclette et de position.



Classic

Rispettando i canoni qualitativi di Selle Royal, la linea Classic propone selle di prima classe ed un comfort accessibile a tutti. La maggior parte dei modelli è realizzata con il Royalgel™ un gel poliuretano che riduce i picchi di pressione di oltre il 40% nelle zone genitali. Alcuni modelli sono imbottiti con il nuovo materiale Slow Fit Foam, una memory foam che si adatta alle forme del corpo.

Confortables et abordables, les selles de notre ligne Classic sont fabriquées selon les standards de Selle Royal pour garantir une qualité exceptionnelle. La plupart des modèles contiennent notre Royalgel™, un gel polyuréthane unique réduisant jusqu'à 40% les pics de pression dans les zones sensibles pour un confort amélioré. Quelques modèles sont rembourés avec le nouveau matériau Slow Fit Foam, une mousse à mémoire de forme qui s'adapte à l'anatomie du corps. Cette ligne est adaptée à la quasi-totalité des activités du quotidien.



COMFORT CARATTERISTICHE | CARACTÉRISTIQUES

Selle Royal ha oltre 50 anni di esperienza in ricerca e sviluppo di materiali innovativi, design e tecnologie avanzate per produrre le selle più confortevoli e di alta prestazione sul mercato. Qui di seguito la lista delle caratteristiche esclusive di Selle Royal:

Le chemin que Selle Royal a parcouru depuis plus de 50 ans est pavé d'innovations permanentes reposant sur la recherche, la technologie et un design à l'avant garde. Nous vous invitons à découvrir les caractéristiques des produits Selle Royal:



3D SKINGEL

3D SKINGEL

3D Skingel è un sistema avanzato e flessibile che posiziona strategicamente il Royalgel™ in accordo con i bisogni anatomici dei ciclisti, garantendo la stessa riduzione di pressione del 40% sia nella zona perianale che nell'area ischiatica, riducendo anche il peso della sella.

3D Skingel est un système flexible innovant, qui positionne de façon judicieuse le Royalgel™ par rapport à l'anatomie des cyclistes, réduisant ainsi de 40 % la pression aussi bien au niveau des ischions que la zone périnéale.



SLOW FIT FOAM

Questa speciale schiuma viscoelastica, attraverso un lento rilascio del materiale stesso, garantisce maggiore comfort adattandosi perfettamente ai punti di contatto del corpo, distribuendo la pressione in modo più uniforme e mantenendo allo stesso tempo un solido supporto.

Grâce à sa capacité de relâchement lente, cette mousse à mémoire de forme procure un confort élevé en préservant les points de contact du corps avec la surface de la selle tout en garantissant une pression uniformément répartie et un soutien optimal.



SuperFabric®

SUPERFABRIC®

È uno dei più innovativi materiali di rivestimento realizzato con due strati di tessuto e uno strato di micro-tasselli protettivi. Questa combinazione a elevato grado di precisione crea una superficie esterna aderente in grado di resistere a tagli, abrasioni e forature, senza comprometterne la flessibilità.

SuperFabric® est la toute nouvelle génération de revêtements. Il est composé de 2 couches de tissus et d'une de fibres synthétiques dont le rôle est de préserver ce revêtement des dégradations. Cette combinaison, résultat d'une étude très poussée, optimise la qualité de la surface en terme de résistance à tous types d'agressions extérieures, sans en altérer la souplesse.



ROYALGEL™

Il Royalgel™ garantisce il più alto livello di comfort, riducendo i picchi di pressione del 40% grazie alla sua speciale struttura tridimensionale.

Royalgel™ garantit un niveau maximum de confort en réduisant jusqu'à 40 % les pics de pression grâce à la structure tridimensionnelle sans égale du gel.



FOAM MATRIX

La struttura cellulare aperta aumenta l'elasticità e la traspirabilità, conferendo alla sella più comfort e resistenza.

La structure cellulaire ouverte du rembourrage augmente l'élasticité et la respirabilité procurant à la selle confort et durabilité.



FLEXITE SYSTEM

Lo scafo FLEXITE è stato creato per coniugare robustezza e flessibilità. L'esclusiva struttura 'scanalata' con intagli nella parte inferiore del corpo della sella ne massimizza le prestazioni, garantendo straordinari livelli di flessibilità e assorbimento degli urti durante la guida.

Cette fabrication innovante garantit une flexibilité et une capacité à absorber les chocs hors du commun. La coque avec canal central augmente les qualités de confort général de la selle.

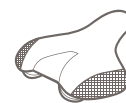

NEW

DOUBLE-COVER SIDE PROTECTION

Doppio strato di tessuto applicato ai lati della sella per una doppia resistenza agli urti e alle abrasioni.

Un matériau double épaisseur appliqué sur les flancs augmente la résistance aux impacts et à l'abrasion.

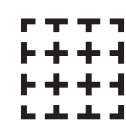

STRENGTEX COVER

La copertina è composta da uno speciale materiale elastico che garantisce alla sella una maggiore resistenza nel tempo.

Le revêtement est réalisé à partir d'un matériau spécial, très élastique, qui garantit à la selle une grande durabilité.



VENTILATION CHANNEL

Riduce la pressione nell'area perineale, migliorando nello stesso tempo la traspirazione.

Réduit la pression sur la zone périnéale tout en réduisant l'effet de sudation.



DOUBLE SPRINGS

Alcune selle della linea Premium e Classic sono dotate di molle biconiche per garantire un'efficace sospensione grazie a due movimenti complementari.

Certaines selles des lignes Premium et Classic sont dotées de double ressorts afin de garantir un meilleur amorti grâce à leurs deux mouvements complémentaires.



WATER RESISTANT

Il Royal Vacuum Light è una tecnologia Selle Royal che permette alla sella di essere al 100% sigillata e il 20% più leggera rispetto alle selle normali della stessa categoria.

RoyalVacuum Light est une technologie Selle Royal qui offre à la selle une étanchéité totale et un gain de poids de 20 % par rapport aux selles d'un même type que l'on trouve sur le marché.

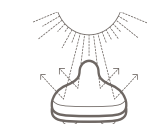

COOL COVER

Grazie ad uno speciale materiale, sotto la luce del sole, la copertina risulta fino a 25°C più fresca rispetto alle altre selle di colore nero.

La qualité spécifique du revêtement de la selle permet, en exposition en plein soleil, de réduire de 25° la température par rapport à des selles courantes de couleur noire.



ELASTOMERS

Sicuri, silezionsi e non deformabili, gli elastomeri possono assorbire anche i colpi più forti e inaspettati grazie alla loro azione sia verticale che orizzontale.

Résistant, silencieux et indéformable, l'élastomère a pour capacité d'absorber les plus gros chocs du fait qu'il travaille de manière verticale et horizontale.



INTEGRATED CLIP SYSTEM

Un sistema di aggancio brevettato, posizionato nel retro della sella per permettere di integrare facilmente luci e borsette Selle Royal.

Un système de fixation breveté placé à l'arrière de la selle permet de fixer facilement un éclairage ou une sacoche de selle.

ezone

Assieme a Designworks, società controllata del Gruppo BMW, Selle Royal ha condotto il primo studio completo tra gli utilizzatori di e-bike, per individuare le caratteristiche prestazionali che possono rappresentare un vantaggio per il design delle selle specifiche per e-bike. Il risultato? eZONE: la prima sella appositamente concepita per migliorare sicurezza, comfort e prestazioni di guida delle e-bike.

En collaboration avec Designworks, filiale du groupe BMW, Selle Royal a entrepris la première enquête exhaustive jamais effectuée sur les utilisateurs d'eBikes dans le but d'identifier les caractéristiques de performances dont pourrait bénéficier une selle spécialement conçue pour les eBikes. Le fruit de cette étude est l'eZONE: la première selle spécialement développée pour améliorer sécurité, confort et performances des utilisateurs d'ebikes.

3D | SKINGEL

SELLE ROYAL

Designed by
Designworks
A BMW Group Company



CARATTERISTICHE | CARACTÉRISTIQUES

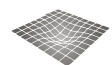

3D Skingel

Comfort Royalgel posizionato in modo intelligente. Una struttura in gel tridimensionale che riduce i picchi di pressione fino al 40%, posizionata in modo intelligente al fine di ridurre il peso generale della sella.

Royalgel est judicieusement positionné pour améliorer le confort. Sa structure de gel tri-dimensionnel permet de réduire jusqu'à 40% les pics de pression et réduit également le poids total de la selle.



eFit Design

Profilo specifico impostazione eBike. Una parte posteriore rialzata impedisce un arretramento della posizione ed il naso più corto aiuta a montare in sella.

Profil d'assise spécial eBike. Partie arrière de la selle relevée destinée à empêcher le cycliste de glisser vers l'arrière; nez plus court pour monter en selle plus facilement.



Acceleration Control

eZONE per una maggiore sicurezza. Tre zone con forme e dimensioni specifiche, dotate di alette flessibili, per un controllo di stabilità migliore e una maggiore sicurezza durante l'accelerazione.

eZONE: Pour une sécurité améliorée. Trois zones de formes et dimensions spécifiques; dotée d'ailettes flexibles permettant d'améliorer le contrôle et l'équilibre; le tout pour une sécurité accrue en phase d'accélération.



eGrip

Impugnatura integrata per il trasporto. Un'impugnatura in vetroresina integrata nel supporto della sella, per agevolare il trasporto a mano della bici senza invadere spazio utile per la batteria o per accessori aggiuntivi.

Poignée intégrée pour le transport. Poignée en fibre de verre, intégrée au rail de la selle, afin de manipuler plus facilement le vélo tout en maintenant un niveau de batterie élevé et garder l'autre main libre.



MODERATE



eZONE



code 54B3UB0A091N5

sizes L 270 mm / W 170 mm / W 470 g

price € 89,90



POP MATERIALS

RETAIL STATION

Colori e design minimal ben concepiti per dare risalto all'ambiente di vendita delle e-bike.

- Materiali resistenti e preziose rifiniture.
- Preassortito con 9 prodotti pronti alla vendita.
- Sella provabile gratuitamente esposta ad altezza occhi in un glorifier dedicato.
- Portadepliant con 10 brochure di prodotto dettagliate.

Design épuré et fonctionnel avec des coloris élégants afin de parfaire l'espace de vente e-Bike.

- Pré rempli de 9 selles prêtes à la vente.
- Selle de démonstration à disposition sur la partie supérieure du présentoir.
- Contient 10 brochures produit

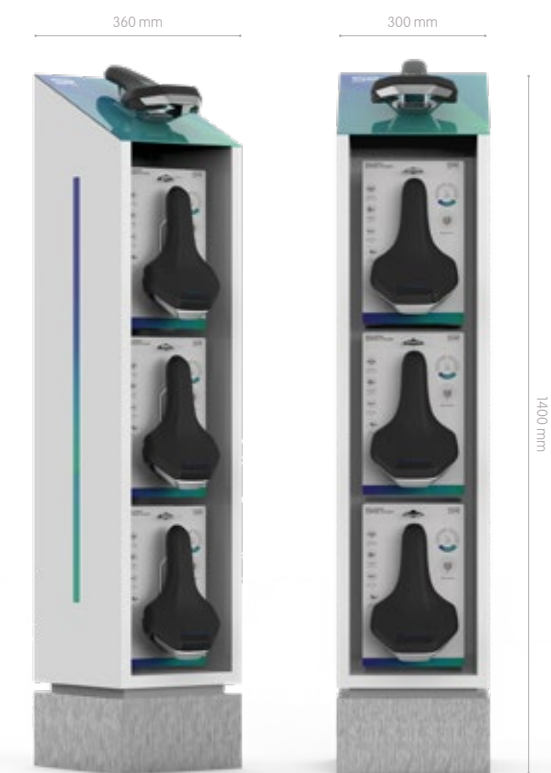

CODE: SREZONEA00000

eZONE WALL DISPLAY

NEW

Display informativo da parete in due lingue (Inglese e Tedesco) dotato di ganci compatibili con slotwall e tegometall.

- Sella test gratuita pre-caricata.
- 4 selle eZone per la vendita.
- Cartello vetrina di eZone in cardboard.

Présentoir mural au design épuré et fonctionnel afin de parfaire l'espace de vente e-Bike.

- Selle de démonstration mise en évidence.
- Pré rempli de 4 selles eZone prêtes à la vente.
- Infos produits eZone sur affiche cartonnée.



CODE: SREZONEA10000

respiro

Se si lascia la bici sotto il calore del sole, la temperatura della sella può aumentare ad un livello spiacevole. Per evitare una cattiva traspirazione e una sensazione di disagio, è stata sviluppata la linea Respiro, progettata con un canale di ventilazione e uno speciale materiale per la copertina che riduce il calore sulla sella.

En laissant sa bicyclette en plein soleil, la température de la couverture de la selle peut augmenter de manière très significative. Pour éviter une sudation désagréable et une gêne a été développée la ligne Respiro, conçue avec un canal de ventilation et un revêtement d'une matière spéciale, qui réduisent la chaleur sur la selle.

Scopri quali caratteristiche sono disponibili per ogni modello di sella. Per saperne di più, torna alla sezione "Caratteristiche".

Découvrez quelles sont les caractéristiques pour chaque selle. Pour en savoir plus revenir à "Caractéristiques".



ATHLETIC

RESPIRO SOFT

UNISEX

code 5130HRTB391L4

sizes L 277 mm / W 163 mm / W 429 g

price € 69,90



MODERATE

RESPIRO SOFT

MEN

code 5131HETB091L4

sizes L 277 mm / W 182 mm / W 535 g

price € 69,90



RESPIRO SOFT

WOMEN

code 5131DETB091L4

sizes L 263 mm / W 199 mm / W 565 g

price € 69,90



RELAXED

RESPIRO SOFT

UNISEX

codice 5132DETB091L4

sizes L 256 mm / W 227 mm / W 825 g

price € 69,90



LOOKIN

La linea Lookin combina un design innovativo al valore del Royalgel™, il gel poliuretano visibile attraverso le finestre sulla copertina che riduce del 40% i picchi di pressione.

La ligne Lookin associe un design innovant aux qualités du gel Royalgel. Ce gel de polyuréthane est visible sur la couverture à travers des fenêtres transparentes. Il réduit de 40% les pics de pression.

Scopri quali caratteristiche sono disponibili per ogni modello di sella. Per saperne di più, torna alla sezione "Caratteristiche".

Découvrez quelles sont les caractéristiques pour chaque selle. Pour en savoir plus revenir à "Caractéristiques".

45° | ATHLETIC

LOOKIN BASIC  UNISEX
code 8229UR1A18096
sizes L 283 mm / W 156 mm / W 440 g
price € 39,90



60° | MODERATE

LOOKIN BASIC  MEN
code 8230HR1A18096
sizes L 276 mm / W 162 mm / W 540 g
price € 39,90



LOOKIN BASIC  WOMEN
code 8230DR1A18096
sizes L 258 mm / W 187 mm / W 560 g
price € 39,90



90° | RELAXED

LOOKIN BASIC  UNISEX
code 8231UR1A18096
sizes L 257 mm / W 212 mm / W 650 g
price € 39,90



45' | ATHLETIC

LOOKIN  UNISEX

code 5234HR3A09188

sizes L 279 mm / W 160 mm / W 475 g

price € 59,90



60' | MODERATE

LOOKIN  MEN

code 5235HE3A09188

sizes L 282 mm / W 185 mm / W 555 g

price € 59,90



LOOKIN  WOMEN

code 5235DE3A09188

sizes L 269 mm / W 198 mm / W 620 g

price € 59,90



90' | RELAXED

LOOKIN  UNISEX

code 5236DE3A09188

sizes L 260 mm / W 228 mm / W 830 g

price € 59,90



Premium

Il massimo comfort, per ogni gusto. Le selle della linea Premium sono realizzate utilizzando la tecnologia Royal Vacuum Light che permette alle selle di essere al 100% sigillate e il 20% più leggere.

Le maximum du confort au goût de chaque cycliste. Les selles de la ligne Premium sont fabriquées à partir de la technologie Royal Vacuum Light qui rend les selles complètement étanches et permet une diminution de 20% du poids.

Scopri quali caratteristiche sono disponibili per ogni modello di sella. Per saperne di più, torna alla sezione "Caratteristiche".

Découvrez quelles sont les caractéristiques pour chaque selle. Pour en savoir plus revenir à "Caractéristiques".



ATHLETIC

ELLIPSE

UNISEX

code 51B5UR0A09320

sizes L 265,5 mm / W 162,6 mm / W 406,3 g

price € 49,90



NEW



MODERATE

ELLIPSE

MEN

code 51B6HE0A09321

sizes L 276,1 mm / W 180 mm / W 474 g

price € 49,90



NEW



ELLIPSE

WOMEN

code 51B6DE0A09321

sizes L 260,6 mm / W 197,5 mm / W 475,3 g

price € 49,90



NEW



RELAXED

ELLIPSE

UNISEX

code 51B7UE0A09321

sizes L 250,5 mm / W 223,4 mm / W 638 g

price € 49,90



NEW



Classic

Rispettando i canoni qualitativi di Selle Royal, la linea Classic propone selle di prima classe ed un comfort accessibile a tutti. La maggior parte dei modelli è realizzata con il Royalgel™ un gel poliuretano che riduce i picchi di pressione di oltre il 40% nelle zone genitali, alcuni modelli sono imbottiti con il nuovo materiale Slow Fit Foam, una memory foam che si adatta alle forme del corpo.

Confortables et d'un prix abordable, les selles de la ligne Classic sont fabriquées selon les standards Selle Royal, garantissant une qualité et un confort exceptionnels. La plupart des modèles contiennent notre Royalgel™, gel polyuréthane qui réduit les pics de pressions de plus de 40% au niveau des zones génitales, pour le plus grand confort de l'utilisateur. Certains modèles sont rembourrés avec le nouveau matériau Slow Fit Foam, mousse à mémoire de forme qui s'adapte à l'anatomie du corps. Cette ligne est parfaitement adaptée à la quasi totalité des pratiques cyclistes au quotidien.

Scopri quali caratteristiche sono disponibili per ogni modello di sella. Per saperne di più, torna alla sezione "Caratteristiche".

Découvrez quelles sont les caractéristiques pour chaque selle. Pour en savoir plus revenir à "Caractéristiques".



ATHLETIC

FORUM

UNISEX

code A132UR0A08069

sizes L 276 mm / W 156 mm / W 453 g

price € 39,90



MODERATE

FORUM

MEN

code A133HR0A08069

sizes L 271 mm / W 180 mm / W 521 g

price € 39,90



FORUM

WOMEN

code A133DR0A08069

sizes L 261 mm / W 189 mm / W 541 g

price € 39,90



RELAXED

FORUM

UNISEX

code A134UR0A08069

sizes L 247 mm / W 214 mm / W 561 g

price € 39,90



45° | ATHLETIC

FREEWAY FIT 
code 8V99UR0A08069
sizes L 280 mm / W 158 mm / W 435 g
price € 34,90



SLOW FIT FOAM



60° | MODERATE

FREEWAY FIT 
code 8V97HR0A08069
sizes L 273 mm / W 160 mm / W 490 g
price € 34,90



SLOW FIT FOAM



FREEWAY FIT 
code 8V97DR0A08069
sizes L 260 mm / W 188 mm / W 520 g
price € 34,90



SLOW FIT FOAM



90° | RELAXED

FREEWAY FIT 
code 8V98UR0A08069
sizes L 257 mm / W 210 mm / W 550 g
price € 34,90



SLOW FIT FOAM



45° | ATHLETIC

MACH 2 
code A008UR0A05515
sizes L 268 mm / W 142 mm / W 369 g
price € 29,90



60° | MODERATE

ROOMY 
code 8VA8HS0A08069
sizes L 265 mm / W 165 mm / W 605 g
price € 24,90



SLOW FIT FOAM



ROOMY 
code 8VA8DS0A08069
sizes L 246 mm / W 181 mm / W 580 g
price € 24,90



SLOW FIT FOAM



90° | RELAXED

AURORAE 
code 8VB4UE0A08069
sizes L 254 mm / W 231 mm / W 673 g
price € 24,90



SLOW FIT FOAM



DRIFTER STRENTEX BLACK

UNISEX

code 5111UDTC25301

sizes L 270 mm / W 245 mm / W 1160 g

price € 49,90



DRIFTER PLUS BROWN

UNISEX

code 5111UDTC38129

sizes L 270 mm / W 245 mm / W 1260 g

price € 49,90



ONDINA BROWN

UNISEX

code 8171US A38129

sizes L 253 mm / W 214 mm / W 690 g

price € 29,90



HOLLAND GEL

UNISEX

code 82615G2A08132

sizes L 247 mm / W 219 mm / W 690 g

price € 24,90



WITCH

UNISEX

code 8013USTA08096

sizes L 260 mm / W 243 mm / W 651 g

price € 19,90



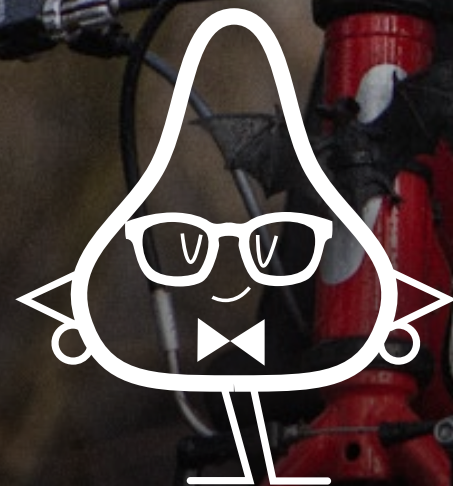

**ENJOY YOUR
BIKE IN SAFETY
WITH MR. ROY**

A project in collaboration with:



FROGGY BOY & GIRL

code 1702JCNA03807

sizes L 202 mm / W 150 mm / W 290 g

price € 9,90



Consigliate per bici da bambini da 12"-14"-16"
Recommandées pour vélos enfants 12"-14"-16"

CANDY GIRL

code 1703DRNA03807

sizes L 230 mm / W 172 mm / W 331 g

price € 9,90



Consigliate per bici da bambine da 16"-20"-24"
Recommandées pour vélos fillettes 16" - 20" - 24"

BEN BOY

code 1703HRNA03807

sizes L 230 mm / W 151 mm / W 305 g

price € 9,90



Consigliate per bici da bambini da 16"-20"-24"
Recommandées pour vélos enfants 16"-20"-24"

HELLO BOY & GIRL

code 1704JRNA03807

sizes L 250 mm / W 151 mm / W 337 g

price € 9,90



Consigliate per bici junior da 24"
Recommandées pour vélo junior 24"



SEAT COVERS

GEL SEAT COVER MEDIUM INDENT

code SCGM100A25800

sizes L 285 mm / W 195 mm / W 363 g

price € 16,90

UNISEX

ROYALGEL™



GEL SEAT COVER LARGE INDENT

code SCGL100A15800

sizes L 258 mm / W 226 mm / W 264 g

price € 16,90

UNISEX

ROYALGEL™



MEMORY FOAM SEAT COVER MEDIUM INDENT

code SCMM003A05800

sizes L 277 mm / W 192 mm / W 242 g

price € 14,90

UNISEX

SLOW FIT FOAM



MEMORY FOAM SEAT COVER LARGE INDENT

code SCML004A05800

sizes L 248 mm / W 220 mm / W 289 g

price € 14,90

UNISEX

SLOW FIT FOAM



BAG

SR SADDLE BAG

code BAGST00A00000

sizes L 131 mm / W 106 mm / W 102 g

price € 16,90



CLAMP

BLACK CLAMP 3 COMPONENTS

single packaging

code V 06 B20000

price € 2,95

SILVER CLAMP 3 COMPONENTS

single packaging

code V 06 B00000

price € 2,45

SILVER CLAMP 5 COMPONENTS 38 D.

single packaging

code V 06 B40000

price € 2,45

BLACK CLAMP 3 COMPONENTS + DADO AUTOBL.

code V 06 B70000

price € 1,99

SILVER CLAMP 5 COMPONENTS 38 D.

code V 06 B80000

price € 1,99

SILVER CLAMP 3 COMPONENTS + DADO AUTOBL.

code V 06 B60000

price € 1,75



SPARE PARTS

Gli Original Spare Parts by Selle Royal sono selle adibite al ricambio e vengono fornite in masterbox dedicati. Sono provviste di un apposito bindello descrittivo invece dell'appendisella.

Les "Original Spare Parts by Selle Royal" sont des pièces de rechange d'origine fournies en cartons contenant un nombre de pièces déterminé. Elles sont pourvues d'une notice explicative au lieu d'un "hang tag".

ATHLETIC



MACH - Box  UNISEX
code SRTC C70000
qty/box 28 pcs



LANCIA - Box  UNISEX
code SRTC C80000
qty/box 20 pcs



ALPINE - Box  UNISEX
code SRTC C90000
qty/box 24 pcs

MODERATE



MOODY - Box  WOMEN
code SRTC C10000
qty/box 18 pcs

RELAXED



HOLLAND NO GEL - Box  UNISEX
code SRTC C40000
qty/box 11 pcs







r.e.med

L'APPROCCIO ERGONOMICO | L'APPROCHE ERGONOMIQUE

Le selle **R.e.Med** sono state progettate per permettere al corpo di distribuire naturalmente lo stress in 3 zone della sella: **AZIONE, RECUPERO** e **SUPPORTO**, donando in questo modo sollievo e comfort, mantenendo una pressione inalterata se si cambia posizione tra il fronte ed il retro della sella.

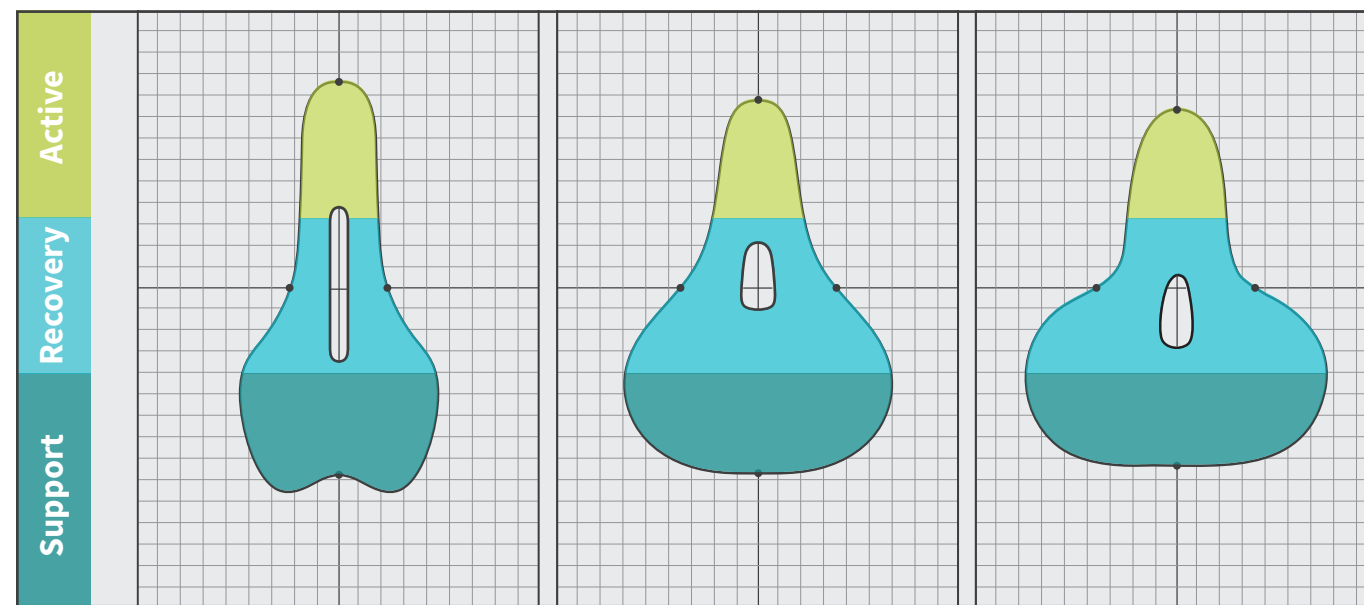
Les selles **R.e.Med** ont été conçues pour permettre au corps de distribuer naturellement le stress sur 3 zones de la selle: **ACTION, RECUPERATION** et **SUPPORT**, procurant ainsi soulagement et confort même en maintenant une pression constante s'il l'on change de position par rapport au bec et à l'arrière de la selle.



LE CARATTERISTICHE | LES CARACTÉRISTIQUES

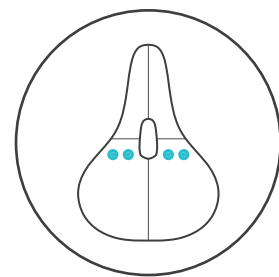

Specific Ergonomic Design

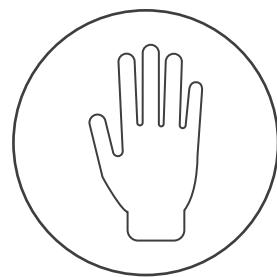

Handmade

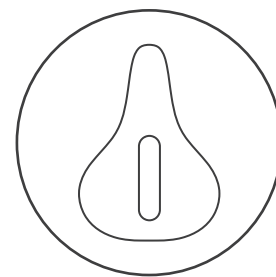

Anatomic Hole

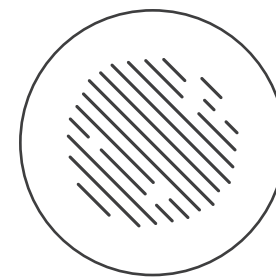

Memory Foam

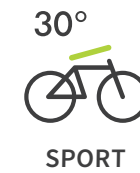

REMED SPORT

code 2354HRMA10004

sizes L 287 mm / W 136 mm / W 316 g

price € 19,90



REMED TREKKING

code 4309DEMA10004

sizes L 257 mm / W 189 mm / W 578 g

price € 19,90



REMED CITY

code 5550UEMA10003

sizes L 249 mm / W 207 mm / W 633 g

price € 19,90



designed in japan / made in italy



RIDE COLLECTION

 SPRING/SUMMER  FALL/WINTER

PEdAL ED



00PE_BLACK

05PE_NAVY

NEW **YUKY WINTER JACKET** ❄️

- REGULAR FIT
- WATER PROOF
- WATER RESISTANT
- THERMO REGULATION
- DRY FAST
- REFLECTIVE DETAILS

- WATER RESISTANT (10.000MM W/C)
- THERMO REGULATION & BREATHABLE
- STRETCH MATERIAL & REFLECTIVE DETAILS
- 5 POCKETS
- WATERPROOF VALUE POCKET
- MADE IN ITALY

85%PA - 15%EA EXTERNAL / 92%PES - 8%EA INTERNAL

CODE 17WJKWI
COLOR ● 00PE_Black
 ● 05PE_Navy
SIZES XXS / XS / S / M / L / XL / XXL
PRICE € 310



00PE_BLACK

07PE_BLUE

NEW **NACHI WATERPROOF JACKET** ☀️ ❄️

- REGULAR FIT
- WATER PROOF
- WATER RESISTANT
- WIND PROOF
- THERMO REGULATION
- DRY FAST
- REFLECTIVE DETAILS

- WATERPROOF
- FULLY TAPED SEAMS
- WINDPROOF
- WATER-RESISTANT ZIP
- SLIM FIT FOR PERFORMANCE
- MADE IN ITALY

100%PA

CODE 174JKGF
COLOR ● 00PE_Black
 ● 07PE_Blue
SIZES XS / S / M / L / XL / XXL
PRICE € 210



00PE_BLACK

13PE_BORDEAUX

07PE_BLUE

NEW **TOKAIDO ALPHA JACKET** ❄️

- REGULAR FIT
- THERMO REGULATION
- DRY FAST
- REFLECTIVE DETAILS

- THERMO REGULATION
- REFLECTIVE DETAILS
- ULTRALIGHT & PACKABLE
- POLARTEC ALPHA®
- MADE IN ITALY

100% PA / 100%PES PADDING

CODE 184JTKT
COLOR ● 00PE_Black ● 13PE_Bordeaux
 ● 07PE_Blue
SIZES XXS / XS / S / M / L / XL / XXL
PRICE € 220



02PE_GREY

17PE_CORAL RED

NEW **HIKARI REFLECTIVE SHELL** ☀️ ❄️

- REGULAR FIT
- WATER PROOF
- REFLECTIVE DETAILS

- WATERPROOF (10.000MM W/C)
- TAPED SEAMS
- STRETCH MATERIAL & REFLECTIVE DETAILS
- MADE IN ITALY

85% POLIAMIDE - 15% ELASTAN / 100% POLIURETANO

CODE 184JKRE
COLOR ● 02PE_Grey
 ● 17PE_Coral Red
SIZES XXS / XS / S / M / L / XL / XXL
PRICE € 265



00PE_BLACK

01PE_WHITE



00PE_BLACK

05PE_NAVY

01PE_WHITE

FUJI TEAM JACKET



- WINDPROOF FRONT PANEL
- PERFORMANCE SLIM FIT
- BREATHABLE STRETCH FLEECE SIDE PANELS
- MADE IN ITALY

74%PP - 26%EA

CODE 17WJKFJ

COLOR ● 00PE_Black
● 01PE_White

SIZES XXS / XS / S / M / L / XL / XXL

PRICE € 180

VESPER PACKABLE JACKET



- WINDPROOF
- REFLECTIVE DETAILS
- LIGHTWEIGHT PACKABLE
- SLIM FIT FOR PERFORMANCE
- MADE IN ITALY

87%PL - 13%EA

CODE 17WJKVS

COLOR ● 00PE_Black ● 01PE_White
● 05PE_Navy

SIZES XXS / XS / S / M / L / XL / XXL

PRICE € 97





00PE_BLACK 13PE_BORDEAUX 07PE_BLUE

NEW TOKAIDO ALPHA PACKABLE VEST ❄️

- REGULAR FIT
- THERMO REGULATION
- DRY FAST
- REFLECTIVE DETAILS

- THERMO REGULATION & BREATHABLE
- REFLECTIVE DETAILS
- ULTRALIGHT & PACKABLE
- MADE IN ITALY

100% PA / 100% PES PADDING

CODE 184VETK
 COLOR ● 00PE_Black ● 13PE_Bordeaux
 ● 07PE_Blue
 SIZES XXS / XS / S / M / L / XL / XXL
 PRICE € 168



00PE_BLACK 07PE_BLUE

NACHI WATERPROOF VEST ☀️ ❄️

- REGULAR FIT
- WATER PROOF
- WATER RESISTANT
- WIND PROOF
- THERMO REGULATION
- DRY FAST
- REFLECTIVE DETAILS

- WATERPROOF
- WINDPROOF
- WATER-RESISTANT ZIP
- SLIM FIT FOR PERFORMANCE
- MADE IN ITALY

85%PA - 15%EA

CODE 174VENC
 COLOR ● 00PE_Black
 ● 07PE_Blue
 SIZES XS / S / M / L / XL / XXL
 PRICE € 109



00PE_BLACK 01PE_WHITE

KAZE ACCESS VEST ☀️ ❄️

- SLIM FIT
- WATER PROOF
- WATER RESISTANT
- WIND PROOF
- THERMO REGULATION
- REFLECTIVE DETAILS

- WINDPROOF & WATERPROOF MEMBRANE
- CHEST POCKET
- PACKABLE
- MADE IN ITALY

100%PA

CODE 164JKVE
 COLOR ● 00PE_Black
 ● 01PE_White
 SIZES XXS / XS / S / M / L / XL / XXL
 PRICE € 98



00PE_BLACK 05PE_NAVY 01PE_WHITE

VESPER PACKABLE VEST ☀️

- REGULAR FIT
- WATER RESISTANT
- WIND PROOF
- REFLECTIVE DETAILS

- WINDPROOF
- REFLECTIVE DETAILS
- LIGHTWEIGHT PACKABLE
- SLIM FIT FOR PERFORMANCE
- MADE IN ITALY

87%PL - 13%EA

CODE 18SVEVS
 COLOR ● 00PE_Black ● 01PE_White
 ● 05PE_Navy
 SIZES XXS / XS / S / M / L / XL / XXL
 PRICE € 87



00PE_BLACK



01PE_WHITE



17PE_CORAL RED

NEW **KOBE THERMO JERSEY** ❄️

- REGULAR FIT
- WATER PROOF
- WATER RESISTANT
- WIND PROOF
- THERMO REGULATION
- DRY FAST
- REFLECTIVE DETAILS

- DRY FAST
- BREATHABLE STRETCH FLEECE SIDE PANELS AND BACK
- PERFORMANCE FIT FOR RIDING
- 2 BIG BACK POCKETS
- MADE IN ITALY

85%PA - 15%EA

CODE 17WJKKT
 COLOR ● 00PE_Black ● 17PE_Coral Red
 ● 01PE_White
 SIZES XS / S / M / L / XL / XXL
 PRICE € 150



00PE_BLACK



02PE_GREY



03PE_MILITARY GREEN



13PE_BORDEAUX

KAIDO JERSEY LONG ❄️

- REGULAR FIT
- THERMO REGULATION
- DRY FAST
- REFLECTIVE DETAILS

- BREATHABLE MERINO WOOL
- THERMO REGULATING & FAST DRYING
- COMFORT FIT & REFLECTIVE DETAILS
- MADE IN ITALY

49%WO - 49%PP - 2%EA

CODE 16WJSKL
 COLOR ● 00PE_Black ● 03PE_Military Green
 ● 02PE_Grey ● 13PE_Bordeaux
 SIZES XS / S / M / L / XL / XXL
 PRICE € 145



00PE_BLACK

SHAWA JERSEY ☀️ ❄️

- REGULAR FIT
- WATER PROOF
- WATER RESISTANT
- WIND PROOF
- THERMO REGULATION
- DRY FAST
- REFLECTIVE DETAILS

- WATERPROOF
- WINDPROOF
- TAPED SEAMS
- STRETCH FABRIC
- WATER-RESISTANT ZIP
- SLIM FIT FOR PERFORMANCE
- MADE IN ITALY

86%PL - 14%EA

CODE 17WJSSA
 COLOR ● 00PE_Black
 SIZES XXS / XS / S / M / L / XL / XXL
 PRICE € 187



00PE_BLACK



02PE_GREY



03PE_M.GREEN



07PE_BLUE



13PE_BORDEAUX



14PE_BROWN

KAIDO JERSEY ☀️ ❄️

- REGULAR FIT
- THERMO REGULATION
- DRY FAST
- REFLECTIVE DETAILS

- BREATHABLE MERINO WOOL
- THERMO REGULATING & FAST DRYING
- COMFORT FIT & REFLECTIVE DETAILS
- MADE IN ITALY

49%WO - 49%PP - 2%EA

CODE 154JSKI
 COLOR ● 00PE_Black ● 07PE_Blue ● 13PE_Bordeaux
 ● 02PE_Grey ● 14PE_Brown ● 03PE_M.Green
 SIZES XS / S / M / L / XL / XXL
 PRICE € 110



00PE_BLACK 02PE_GREY 07PE_BLUE 13PE_BORDEAUX

ESSENTIAL LONG SLEEVE



- MERINO BREATHABLE STRETCH FABRIC
- LYCRA RIB CUFFS
- REFLECTIVE ELEMENTS
- 3 BIG BACK POCKETS
- EAR PHONE OPENING IN THE BACK POCKET
- MADE IN ITALY

30% MERINO WOOL - 70% POLYESTER

CODE 17WJSES

COLOR ● 00PE_Black ● 07PE_Blue
● 02PE_Grey ● 13PE_Bordeaux

SIZES XS / S / M / L / XL / XXL

PRICE € 125



00PE_BLACK 05PE_NAVY 06PE_RED 15PE_YELLOW 01PE_WHITE 17PE_CORAL RED

SHIBUYA LIGHTWEIGHT JERSEY



- 115 GRAMS M SIZE
- ULTRA LIGHT WEIGHT AND BREATHABLE
- COMPRESSION FIT FOR AERODYNAMIC
- SLIM FIT FOR PERFORMANCE
- MADE IN ITALY

74%PP - 26%EA

CODE 164JSLW

COLOR ● 00PE_Black ● 05PE_Navy ● 01PE_White
● 06PE_Red ● 15PE_Yellow ● 17PE_Coral Red

SIZES XS / S / M / L / XL / XXL

PRICE € 135



00PE_BLACK 01PE_WHITE 05PE_NAVY 13PE_BORDEAUX

NARITA CARBON JERSEY



- BREATHABLE & ANTIBACTERIAL
- 3 POCKETS + ZIPPED VALUABLES POCKET
- SLIM FIT & REFLECTIVE DETAILS
- MADE IN ITALY

100%PL

CODE 164JSNC

COLOR ● 00PE_Black ● 05PE_Navy
● 01PE_White ● 13PE_Bordeaux

SIZES XS / S / M / L / XL / XXL

PRICE € 120



01PE_WHITE 02PE_GREY 06PE_RED 07PE_BLUE 12PE_ORANGE

HEIKO JERSEY



- UV PROTECTION FABRIC
- LIGHTWEIGHT AND BREATHABLE
- COMPRESSION FIT FOR AERODYNAMIC
- SLIM FIT FOR PERFORMANCE
- MADE IN ITALY

73%PA - 27%EA

CODE 184JSHK

COLOR ● 02PE_Grey ● 06PE_Red ● 12PE_Orange
● 01PE_White ● 07PE_Blue

SIZES XS / S / M / L / XL / XXL

PRICE € 100



NAGOYA AERO JERSEY



- 109 GRAMS M SIZE
- ULTRA LIGHT WEIGHT AND BREATHABLE
- COMPRESSION FIT FOR AERODYNAMIC
- SLIM FIT FOR PERFORMANCE
- MADE IN ITALY

74%PL - 26%EA



00PE_BLACK

06PE_RED

07PE_BLUE

CODE 17SJSNA

COLOR ● 00PE_Black ● 07PE_Blue
● 06PE_Red

SIZES XS / S / M / L / XL / XXL

PRICE € 160



00PE_BLACK

ULTRALIGHT BASELAYER



- DRY FAST WITH DRYARN®
- THERMO REGULATING & BREATHABLE
- ODOR CONTROL
- MADE IN ITALY

89%PP - 11%EA

CODE 164JSUL

COLOR ● 00PE_Black

SIZES XS / S / M / L / XL / XXL

PRICE € 55



00PE_BLACK

ULTRALIGHT BASELAYER SLEEVELESS



- DRY FAST WITH DRYARN®
- THERMO REGULATING & BREATHABLE
- ODOR CONTROL
- MADE IN ITALY

89%PP - 11%EA

CODE 164JSUS

COLOR ● 00PE_Black

SIZES S / M / L / XL / XXL

PRICE € 48



00PE_BLACK



00PE_BLACK

07PE_BLUE

17PE_CORAL RED

13PE_BORDEAUX

MERINO BASELAYER LONG SLEEVE



- BREATHABLE STRETCH FLEECE
- PERFORMANCE FIT FOR RIDING
- FABRIC HELPS KEEP YOU DRY AND COMFORTABLE
- ERGONOMIC CUT FOR STRETCH AND MOBILITY
- MADE IN ITALY

100%WO

CODE 17WJSML

COLOR ● 00PE_Black

SIZES XS / S / M / L / XL / XXL

PRICE € 70

MERINO BASELAYER SLEEVELESS



- BREATHABLE STRETCH FLEECE
- PERFORMANCE FIT FOR RIDING
- FABRIC HELPS KEEP YOU DRY AND COMFORTABLE
- ERGONOMIC CUT FOR STRETCH AND MOBILITY
- MADE IN ITALY

67% WO - 22% PA - 11% EA

CODE 184JSMS

COLOR ● 00PE_Black ● 17PE_Coral Red
● 07PE_Blue ● 13PE_Bordeaux

SIZES XXS / XS / S / M / L / XL / XXL

PRICE € 60





00PE_BLACK

TEAM WINTER TIGHT



- DRY FAST
- WIND PROOF FRONT PANNEL
- INTERNAL FLEECE
- SLIM FIT FOR PERFORMANCE
- MADE IN ITALY

85%PA - 15%EA

CODE 17WSPWT

COLOR ● 00PE_Black

SIZES XS / S / M / L / XL / XXL

PRICE € 178



00PE_BLACK

DAIKANN WINTER BIBSHORT



- DRY FAST
- REFLECTIVE LOGOS
- INTERNAL FLEECE
- SLIM FIT FOR PERFORMANCE
- MADE IN ITALY

85%PA - 15%EA

CODE 16WSPBB

COLOR ● 00PE_Black

SIZES XS / S / M / L / XL / XXL

PRICE € 155



00PE_BLACK

NAGOYA AERO BIBSHORT



- BREATHABLE & FAST DRYING
- TOP-PERFORMANCE CYTECH® PAD
- CUFFS FOR SENSITIVE SKIN
- CUT FOR AERODYNAMIC PERFORMANCE
- MADE IN ITALY

53%PA - 43%EA

CODE 17SSPNA

COLOR ● 00PE_Black

SIZES XS / S / M / L / XL / XXL

PRICE € 180



00PE_BLACK

14PE_BROWN

RAKU BIBSHORT



- MID-SEASON FABRIC FOR THERMO REGULATION
- PANEL CONSTRUCTION FOR THE BEST FIT
- MESH BACK PANELS ENHANCE BREATHABILITY
- FLAT SEAMS MOVE SMOOTHLY AGAINST YOUR SKIN
- BACTERIOSTATIC PAD BY ELASTIC INTERFACE®
- REGULAR FIT FOR COMFORT
- MADE IN ITALY

59%PA - 41%EA

CODE 154SPBB

COLOR ● 00PE_Black

● 14PE_Brown

SIZES XS / S / M / L / XL / XXL

PRICE € 120



00PE_BLACK 05PE_NAVY 13PE_BORDEAUX

NATSU BIBSHORT



- BREATHABLE & FAST DRYING
- TOP-PERFORMANCE CYTECH® PAD
- CUFFS FOR SENSITIVE SKIN
- HIGH CUT WAIST FOR COMFORT FIT
- MADE IN ITALY

85%PA - 15%EA

CODE 15SSPBB
 COLOR ● 00PE_Black ● 05PE_Navy
 ● 13PE_Bordeaux
 SIZES XS / S / M / L / XL / XXL
 PRICE € 135



01PE_WHITE 02PE_GREY 06PE_RED 07PE_BLUE 12PE_ORANGE

HEIKO BIBSHORT



- BREATHABLE & FAST DRYING
- TOP-PERFORMANCE CYTECH® PAD
- CUFFS FOR SENSITIVE SKIN
- HIGH CUT WAIST FOR COMFORT FIT
- MADE IN ITALY

78%PA - 22%EA

CODE 184BBHK
 COLOR ● 02PE_Grey ● 06PE_Red ● 12PE_Orange
 ● 01PE_White ● 07PE_Blue
 SIZES XS / S / M / L / XL / XXL
 PRICE € 120



00PE_BLACK

3/4 BIBSHORT



- DRY FAST
- WIND PROOF FRONT PANNEL
- INTERNAL FLEECE
- SLIM FIT FOR PERFORMANCE
- MADE IN ITALY

100%PL - 85%PL - 15%EA

CODE 17WSPKN
 COLOR ● 00PE_Black
 SIZES XS / S / M / L / XL / XXL
 PRICE € 160



00PE_BLACK

KYOTO GRAVEL SHORTS



- PERFORMANCE FABRIC
- STRETCH SADDLE ZONE
- SEALED POCKET
- SLIM FIT FOR PERFORMANCE
- MADE IN ITALY

100%PL

CODE 16SSPGR
 COLOR ● 00PE_Black
 SIZES XS / S / M / L / XL / XXL
 PRICE € 115



00PE_BLACK

NEW **SHAWA REFLECTIVE CAP** ❄️

- REFLECTIVE DETAILS
- WATERPROOF
- BREATHABLE
- STRETCH FABRIC
- MADE IN ITALY

86% PL - 14% EA

CODE 18WCASA
COLOR ● 00PE_Black
SIZES UNIQUE
PRICE € 45

WINTER CYCLING HAT ❄️

- WINDPROOF
- WINDTEX® FABRIC
- BREATHABLE
- ONE SIZE FITS ALL
- MADE IN ITALY

100%PL

CODE 15WCAWT
COLOR ● 00PE_Black
SIZES UNIQUE
PRICE € 35

WINTER SKULL CAP ❄️

- REFLECTIVE DETAILS
- THERMO REGULATION
- WINDPROOF
- STRETCH FABRIC
- BREATHABLE
- MADE IN EU

85%PA - 15%EA

CODE 17WCASK
COLOR ● 00PE_Black
SIZES UNIQUE
PRICE € 27



01PE_WHITE 05PE_NAVY 11PE_GREEN 13PE_BORDEAUX

SUMMER CAP BANDANA ☀️ ❄️

- REGULAR FIT
- DRY FAST

- ORIGINAL JAPANESE BANDANA FABRIC
- BREATHABLE & COMFORT FIT
- LIGHTWEIGHT & NATURAL
- MADE IN ITALY

100%CO

CODE 164CASC
COLOR ● 01PE_White ● 11PE_Green
 ● 05PE_Navy ● 13PE_Bordeaux
SIZES UNIQUE
PRICE € 20





00PE_BLACK 02PE_GREY 13PE_BORDEAUX 07PE_BLUE 14PE_BROWN 03PE_MIL.GREEN



00PE_BLACK 13PE_BORDEAUX 07PE_BLUE

KUBI NECK WARMER



- BREATHABLE MERINO WOOL
- THERMO REGULATING & FAST DRYING
- COMFORT FIT & REFLECTIVE DETAILS
- MADE IN ITALY

49%WO - 49%PP - 2%EA

CODE 164ACNW
 COLOR ● 00PE_Black ● 03PE_M.Green ● 14PE_Brown
 ● 02PE_Grey ● 07PE_Blue ● 13PE_Bordeaux
 SIZES UNIQUE
 PRICE € 20

NEW

TOKAIDO ALPHA NECK WARMER



- THERMO REGULATION & BREATHABLE
- REFLECTIVE DETAILS
- ULTRALIGHT & PACKABLE
- MADE IN ITALY

100% PA / 100%PES PADDING

CODE 18WACNW
 COLOR ● 00PE_Black ● 13PE_Bordeaux
 ● 07PE_Blue
 SIZES UNIQUE
 PRICE € 46



00PE_BLACK



00PE_BLACK

LEG WARMER



- REFLECTIVE DETAILS
- THERMO REGULATING
- COMFORT FIT & STRETCH FABRIC
- MADE IN ITALY

85% POLYAMIDE - 15% ELASTANE

CODE 16WACLW
 COLOR ● 00PE_Black
 SIZES XS / S / M / L / XL
 PRICE € 50

TEAM ARM WARMER



- LIGHTWEIGHT AND BREATHABLE
- COMPRESSION FIT FOR AERODYNAMIC
- SLIM FIT FOR PERFORMANCE
- MADE IN ITALY

85%PA - 15%EA

CODE 16SACFA
 COLOR ● 00PE_Black
 SIZES XS / S / M / L / XL / XXL
 PRICE € 40



00PE_BLACK 02PE_GREY 03PE_MIL.GREEN 07PE_BLUE 14PE_BROWN 13PE_BORDEAUX

KAIDO ARM WARMER



- BREATHABLE MERINO WOOL
- THERMO REGULATING & FAST DRYING
- COMFORT FIT & REFLECTIVE DETAILS
- MADE IN ITALY

80%PL - 10%EA

CODE 154AWKA
COLOR ● 00PE_Black ● 07PE_Blue ● 03PE_M.Green
 ● 02PE_Grey ● 14PE_Brown ● 13PE_Bordeaux
SIZES XS / S / M / L / XL / XXL
PRICE € 40

NEW

HEIKO ARM WARMER



- UV PROTECTION FABRIC
- BREATHABLE
- DRY FAST
- ULTRALIGHT MATERIAL
- STRETCH FABRIC
- MADE IN ITALY

73% MICROFIBRE PA - 27 % EA (LYCRA®)

CODE 184AWHK
COLOR ● 01PE_White ● 07PE_Blue ● 12PE_Orange
 ● 02PE_Grey ● 06PE_Red
SIZES XXS / XS / S / M / L / XL
PRICE € 37



01PE_WHITE 02PE_GREY 06PE_RED 07PE_BLUE 12PE_ORANGE



00PE_BLACK

SHAWA ARM WARMER



- WATERPROOF
- WINDPROOF
- TAPED SEAMS
- STRETCH FABRIC
- WATER-RESISTANT ZIP
- SLIM FIT FOR PERFORMANCE
- MADE IN ITALY

85%PL - 15%EA

CODE 17WACSA
COLOR ● 00PE_Black
SIZES XS / S / M / L / XL
PRICE € 50





reflective view

38PE_GREY/REFLECTIVE

NEW REFLECTIVE THERMO GLOVES ❄️

REGULAR FIT THERMO REGULATION REFLECTIVE DETAILS

- REFLECTIVE DETAILS
- BREATHABLE
- STRETCH FABRIC
- MADE IN ITALY

85%PL - 15%EA

CODE 18WACRG
 COLOR ● 38PE_Grey/Reflective
 SIZES S / M / L / XL
 PRICE € 80



00_BLACK

01_WHITE

FULLFINGER GLOVES ☀️ ❄️

SLIM FIT THERMO REGULATION DRY FAST REFLECTIVE DETAILS

- LIGHTWEIGHT FABRIC
- PADDED LEATHER PALM FOR COMFORT AND PROTECTION
- MADE IN EU

80%PL - 20%EA

CODE 164ACGL
 COLOR ● 00PE_Black
 ○ 01PE_White
 SIZES S / M / L / XL
 PRICE € 50



00PE_BLACK

07PE_BLUE

13PE_BORDEAUX

THERMO GLOVES ❄️

REGULAR FIT WATER RESISTANT WIND PROOF THERMO REGULATION REFLECTIVE DETAILS

- WARM FABRIC
- SOFT TOUCH
- FLEECE LINING
- THERMAL & WIND RESISTANT PANELS
- MADE IN EU

85%PL - 15%EA

CODE 16WACGL
 COLOR ● 00PE_Black ● 07PE_Blue
 ● 13PE_Bordeaux
 SIZES S / M / L / XL
 PRICE € 65



00PE_BLACK

01PE_WHITE

13PE_BORDEAUX

07PE_BLUE

15PE_YELLOW

LIGHTWEIGHT GLOVES ☀️

SLIM FIT REFLECTIVE DETAILS

- LIGHTWEIGHT FABRIC
- PADDED LEATHER PALM FOR COMFORT AND PROTECTION
- MADE IN EU

80%PL - 20%EA

CODE 16SACGL
 COLOR ● 00PE_Black ● 07PE_Blue ● 13PE_Bordeaux
 ○ 01PE_White ● 15PE_Yellow
 SIZES S / M / L / XL
 PRICE € 39



00PE_BLACK

RAIN & WIND OVERSHOES



- WARM INSIDE FABRIC
- STRATEGIC REINFORCEMENT
- WINDPROOF PANELS
- MADE IN EU

100%PL

CODE 164ACOS

COLOR ● 00PE_Black

SIZES S 35 - 39 / M 40 - 44 / L 45 - 48

PRICE € 60

THERMO OVERSHOES



- WINDPROOF PANELS
- WARM FABRIC
- VIBRAM® GRIP SOLE MATERIAL
- MADE IN EU

86%PL - 14%EA

CODE 16WACOS

COLOR ● 00PE_Black

SIZES S 35 - 39 / M 40 - 44 / L 45 - 48

PRICE € 65



00PE_BLACK





00PE_BLACK

01PE_WHITE

MERINO WINTER SOCKS



- DRY FAST & COMFORT
- SNUG FIT FOR SUPPORT
- REINFORCED TOE & HEEL
- MADE IN ITALY

65%WO - 20%PA - 15%EA

CODE 17WPSMS

COLOR ● 00PE_Black
● 01PE_White

SIZES S 35 - 39 / M 40 - 44 / L 45 - 48

PRICE € 18



00PE_BLACK

01PE_WHITE

MERINO SOCKS FLAG



- DRY FAST & COMFORT
- SNUG FIT FOR SUPPORT
- REINFORCED TOE & HEEL
- MADE IN ITALY

60%WO - 30%EA - 5%PP - 5%PA

CODE 17WMSFL

COLOR ● 00PE_Black
● 01PE_White

SIZES S 35 - 39 / M 40 - 44 / L 45 - 48

PRICE € 18



00PE_BLACK

01PE_WHITE

07PE_BLUE

MERINO WINTER SOCKS POIS



- DRY FAST & COMFORT
- SNUG FIT FOR SUPPORT
- REINFORCED TOE & HEEL
- MADE IN ITALY

65%WO - 20%PA - 15%EA

CODE 17WPSMP

COLOR ● 00PE_Black ● 07PE_Blue
● 01PE_White

SIZES S 35 - 39 / M 40 - 44 / L 45 - 48

PRICE € 18



00PE_BLACK

01PE_WHITE

07PE_BLUE

BRITISH SOCKS



- DRY FAST & COMFORT
- SNUG FIT FOR SUPPORT
- REINFORCED TOE & HEEL
- MADE IN ITALY

85%PA - 15%EA

CODE 18SSJLT

COLOR ● 00PE_Black ● 07PE_Blue
● 01PE_White

SIZES S 35 - 39 / M 40 - 44 / L 45 - 48

PRICE € 16



PRO SOCKS PLAIN



- DRY FAST & COMFORT
- SNUG FIT FOR SUPPORT
- REINFORCED TOE & HEEL
- MADE IN ITALY

60%WO - 20%PA - 15%EA

CODE 164PSPL

COLOR ● 00PE_Black ● 07PE_Blue
 ● 01PE_White ● 06PE_Red

SIZES S 35 - 39 / M 40 - 44 / L 45 - 48

PRICE € 16



00PE_BLACK 01PE_WHITE 06PE_RED 07PE_BLUE



PRO SOCKS BIG STRIPE



- DRY FAST & COMFORT
- SNUG FIT FOR SUPPORT
- REINFORCED TOE & HEEL
- MADE IN ITALY

20%PP - 13%VI - 13%CO - 53%PA - 1%EA

CODE 164PSBS

COLOR ● 00PE_Black ● 07PE_Blue
 ● 06PE_Red

SIZES S 35 - 39 / M 40 - 44 / L 45 - 48

PRICE € 16



00PE_BLACK 06PE_RED 07PE_BLUE



REFLECTIVE SOCKS ONE STRIPE



- REFLECTIVE
- DRY FAST & COMFORT
- SNUG FIT FOR SUPPORT
- REINFORCED TOE & HEEL
- MADE IN ITALY

55%WO - 30%EA - 5%PP - 5%PA

CODE 17WMS1S

COLOR ● 00PE_Black ● 07PE_Blue
 ● 13PE_Bordeaux

SIZES S 35 - 39 / M 40 - 44 / L 45 - 48

PRICE € 24



00PE_BLACK 07PE_BLUE 13PE_BORDEAUX



REFLECTIVE SOCKS THREE STRIPES



- REFLECTIVE
- DRY FAST & COMFORT
- SNUG FIT FOR SUPPORT
- REINFORCED TOE & HEEL
- MADE IN ITALY

55%WO - 30%EA - 5%PP - 5%PA

CODE 17WMS3S

COLOR ● 00PE_Black ● 07PE_Blue
 ● 13PE_Bordeaux

SIZES S 35 - 39 / M 40 - 44 / L 45 - 48

PRICE € 24



00PE_BLACK 07PE_BLUE 13PE_BORDEAUX



07PE_BLUE



15PE_YELLOW

06PE_RED

01PE_WHITE

02PE_GREY

12PE_ORANGE

HEIKO SOCKS



- DRY FAST & COMFORT
- SNUG FIT FOR SUPPORT
- REINFORCED TOE & HEEL
- MADE IN ITALY

65%WO - 20%PA - 15%EA

CODE 184SSHK

COLOR ● 12PE_Orange ● 15PE_Yellow ● 01PE_White
 ● 02PE_Grey ● 07PE_Blue ● 06PE_Red

SIZES S 35 - 39 / M 40 - 44 / L 45 - 48

PRICE € 13



800 ML

00PE_BLACK

MIZU WATERBOTTLE 800 ML



- DRY FAST & COMFORT
- SNUG FIT FOR SUPPORT
- REINFORCED TOE & HEEL
- MADE BY ELITE®

100%PE

CODE 164ACWB

COLOR ● 00PE_Black

SIZES UNIQUE

PRICE € 9



99PE_MULTICOLOR



600 ML

00PE_BLACK

TEAM WATERBOTTLE 600 ML



- DRY FAST & COMFORT
- SNUG FIT FOR SUPPORT
- REINFORCED TOE & HEEL
- MADE BY ELITE®

100%PE

CODE 174AWB6

COLOR 99PE_Multicolor
 ● 00PE_Black

SIZES UNIQUE

PRICE € 9

designed in japan / made in italy



JLT / CONDOR TEAM COLLECTION

☀️ SPRING/SUMMER ❄️ FALL/WINTER

PEdAL ED



JLT JERSEY



- 109 GRAMS
- ULTRA LIGHTWEIGHT AND BREATHABLE
- AERO CUT AND SEAMLESS SHOULDER FOR AERODYNAMICS
- COMPRESSION FIT FOR PERFORMANCE
- ASYMETRIC THREE REAR POCKETS FOR ADDITIONAL STORAGE
- MESH SIDE AND BACK PANELS FOR ADDITIONAL BREATHABILITY
- MADE IN ITALY

CODE 17SJSJL

COLOR ● 07PE_Blue

SIZES XXS / XS / S / M / L / XL / XXL

PRICE € 135



JLT BIBSHORT



- PANEL CONSTRUCTION FOR THE BEST FIT
- LIGHT AND HIGH-WICKING LYCRA® FABRIC UV PROTECTION
- OVAL BACK SUPPORT PROVIDES STABILITY
- MESH BACK PANELS ENHANCE BREATHABILITY
- FLAT SEAMS MOVE SMOOTHLY AGAINST YOUR SKIN FOR SUPPORT AND COMFORT
- BACTERIOSTATIC PAD BY ELASTIC INTERFACE®
- SLIM FIT FOR PERFORMANCE
- MADE IN ITALY

CODE 17SSPJL

COLOR ● 00PE_Black

SIZES XXS / XS / S / M / L / XL / XXL

PRICE € 140



JLT GILET



- WIND RESISTANT FABRIC FOR CHALLENGING CONDITIONS
- ULTRALIGHT AND PACKABLE
- STRETCH FABRIC FOR COMFORT
- ELASTICATED WAIST AND ARMHOLES
- REFLECTIVE PEDALED LOGO ON REAR
- SLIM FIT FOR PERFORMANCE
- MADE IN ITALY

CODE 174VEJL

COLOR ● 07PE_Blue

SIZES XXS / XS / S / M / L / XL / XXL

PRICE € 95



JLT CAP



- LIGHTWEIGHT AND DRY FAST
- ELASTIC HEADBAND PROVIDE A SNUG, COMFORTABLE FIT
- REGULAR FIT FOR COMFORT
- TEAM LOGO ON THE FRONT
- MADE IN ITALY

CODE 17SCAJL

COLOR ● 07PE_Blue

SIZES UNIQUE

PRICE € 18

designed in japan / made in italy



☀️ SPRING/SUMMER ❄️ FALL/WINTER

PEdAL ED



05PE_NAVY 13PE_BORDEAUX 14PE_BROWN 27PE_PETROL

SADDLE PACKABLE JACKET



- WATER RESISTANT
- WINDPROOF
- LIGHTWEIGHT & PACKABLE
- MADE IN ITALY

53%PA - 47%CO

CODE 164JKSD
 COLOR ● 05PE_Navy ● 27PE_Petrol
 ● 14PE_Brown ● 13PE_Bordeaux
 SIZES XS / S / M / L / XL
 PRICE € 230



00PE_BLACK 07PE_BLUE

DISCOVERY SHELL JACKET



- WATERPROOF (10.000MM W/C)
- THERMO REGULATING & BREATHABLE
- STRETCH SOFTSHELL MATERIAL
- MADE IN ITALY

86%PA - 14%EA

CODE 154JKDS
 COLOR ● 00PE_Black
 ● 07PE_Blue
 SIZES S / M / L / XL
 PRICE € 220



00PE_BLACK 02PE_GREY 03PE_MILITARY G. 07PE_BLUE 27PE_PETROL

ATTAKAI WOOL JACKET



- WOOL BLEND
- SHOULDER PROTECTION
- 2 BACK POCKET
- MADE IN ITALY

56%WO - 30%CO - 14%PA

CODE 16WJKWJ
 COLOR ● 02PE_Grey ● 07PE_Blue ● 27PE_Petrol
 ● 03PE_Military Green ● 00PE_Black
 SIZES XS / S / M / L / XL / XXL
 PRICE € 160



07PE_BLUE

NEW

SHIRO URBAN JACKET



- WATERPROOF (10.000MM W/C)
- TAPED SEAMS
- BREATHABLE
- REFLECTIVE DETAILS
- 4 WATERPROOF VALUE POCKETS
- MADE IN ITALY

100%PES / 100%PU MEMBRANE

CODE 184JKSH
 COLOR ● 07PE_Blue
 SIZES XS / S / M / L / XL / XXL
 PRICE € 480



05PE_NAVY



00PE_BLACK 02PE_GREY 03PE_MIL_GREEN 04PE_BEIGE 07PE_BLUE 13PE_BORDEAUX

TAGI MERINO PULLOVER



- FINE MERINO
- BREATHABLE
- ODOR CONTROL
- THERMO REGULATION
- MADE IN ITALY

100%WO

CODE 16WJSTA

COLOR ● 00PE_Black ● 13PE_Bordeaux ● 03PE_Mil.Green
● 02PE_Grey ● 07PE_Blue ● 04PE_Beige ● 05PE_Navy

SIZES XS / S / M / L / XL / XXL

PRICE € 160



00PE_BLACK 02PE_GREY 07PE_BLUE

KONCHA COTTON JACKET



- YKK ZIP SYSTEM
- SHOULDER PROTECTION
- 2 BACK POCKET
- MADE IN ITALY

90%CO - 10%PA

CODE 174JKKO

COLOR ● 00PE_Black ● 07PE_Blue
● 02PE_Grey

SIZES XS / S / M / L / XL / XXL

PRICE € 150



00PE_BLACK 01PE_WHITE 05PE_NAVY

GARAGE LINEN SHIRT



- LIGHTWEIGHT AND COMFORTABLE
- EASY-CARE QUICK-DRYING LINEN BODY
- CHEST POCKET FOR VALUABLES
- BACKSIDE STRETCH COTTON PANEL LETS YOU MOVE NATURALLY
- DROPPED BACK HEM ENHANCES COVERAGE WHILE RIDING
- UNDERARM INSETS FOR ENHANCED RANGE OF MOTION
- REGULAR FIT FOR COMFORT
- MADE IN ITALY

75%LI - 25%CO

CODE 15WSHGS

COLOR ● 00PE_Black ● 05PE_Navy
● 01PE_White

SIZES XS / S / M / L / XL

PRICE € 135



34PE_PINK 12PE_ORANGE 36PE_LIME

OSAKA RIDING POLO



- BACKSIDE ZIPPED POCKET
- BREATHABLE
- REGULAR FIT FOR RELAXED COMFORT
- MADE IN ITALY

100%CO

CODE 18SJSOP

COLOR ● 12PE_Orange ● 36PE_Lime
● 34PE_Pink

SIZES XS / S / M / L / XL

PRICE € 80



00PE_BLACK 02PE_GREY 05PE_NAVY 13PE_BORDEAUX

TOKYO POLO LONG



- FINE COTTON
- BREATHABLE
- COMFORT FIT
- DRY FAST
- MADE IN ITALY

100%CO

CODE 17WJSPL

COLOR ● 00PE_Black ● 05PE_Navy
● 02PE_Grey ● 13PE_Bordeaux

SIZES XS / S / M / L / XL

PRICE € 90



02PE_GREY 05PE_NAVY 13PE_BORDEAUX

TOKYO POLO



- FINE COTTON
- BREATHABLE
- COMFORT FIT
- DRY FAST
- MADE IN ITALY

100%CO

CODE 16SJSRP

COLOR ● 05PE_Navy ● 13PE_Bordeaux
● 02PE_Grey

SIZES S / M / L / XL

PRICE € 78



00PE_BLACK 01PE_WHITE 13PE_BORDEAUX

LOGO TEE



- CUT LONGER IN THE BACK
- COLOURED WITH NATURAL DYE
- RELAXED FIT
- MADE IN ITALY

100%CO

CODE 15WTSLO

COLOR ● 00PE_Black ● 13PE_Bordeaux
● 01PE_White

SIZES XXS / XS / S / M / L / XL / XXL

PRICE € 49



00PE_BLACK 17PE_CORAL RED 13PE_BORDEAUX

IKI MERINO T-SHIRT



- ULTRALIGHT WOOL
- BACK CUT FOR VENTILATION
- REFLECTIVE DETAILS
- MADE IN ITALY

67%WO - 22%PA - 11%EA

CODE 184TSIK

COLOR ● 00PE_Black ● 13PE_Bordeaux
● 17PE_Coral Red

SIZES XS / S / M / L / XL

PRICE € 70



09PE_DENIM BLUE

REFLECTIVE DENIM



- REFLECTIVE DETAILS
- BREATHABLE
- STRETCH FABRIC
- MADE IN JAPAN

97% COTTON - 3% ELASTANE

CODE 154LPRD

COLOR ● 09PE_Denim Blue

SIZES 30 / 32 / 34 / 36 / 38

PRICE € 150



03PE_MILITARY GREEN

04PE_BEIGE

05PE_NAVY



00PE_BLACK

37PE_LIGHT GREEN

09PE_DENIM BLUE

CYCLING CHINOS



- COMFORT FIT & STRETCH FABRIC
- REFLECTIVE DETAILS
- CHAIN PROTECTION
- MADE IN ITALY

98%CO - 2%EA

CODE 164LPCC

COLOR ● 04PE_Beige ● 05PE_Navy

● 03PE_Military Green

SIZES 28 / 30 / 32 / 34 / 36 / 38

PRICE € 99

CYCLING CHINOS SHORTS

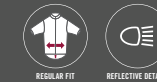

- COMFORT FIT
- STRETCH FABRIC
- REFLECTIVE DETAILS
- MADE IN ITALY

98%CO - 2%EA

CODE 18SSPCC

COLOR ● 37PE_Light Green ● 00PE_Black

● 09PE_Denim blue

SIZES 28 / 30 / 32 / 34 / 36 / 38

PRICE € 85



00PE_BLACK



03PE_MILITARY GREEN



06PE_RED



00PE_BLACK



06PE_RED



07PE_BLUE

DARIO SOCKS SOLID



- DRY FAST & COMFORT
- SNUG FIT FOR SUPPORT
- REINFORCED TOE & HEEL
- MADE IN ITALY

20%PP DRYARN - 13%LENPUR - 53%PA - 13%CO - 1%EA

CODE 164WSON

COLOR ● 00PE_Black ● 03PE_Military Green
● 06PE_Red

SIZES S 35 - 39 / M 40 - 44 / L 45 - 48

PRICE € 15

DARIO SOCKS DOT



- DRY FAST & COMFORT
- SNUG FIT FOR SUPPORT
- REINFORCED TOE & HEEL
- MADE IN ITALY

20%PP DRYARN - 13%LENPUR - 53%PA - 13%CO - 1%EA

CODE 164WSDO

COLOR ● 00PE_Black ● 07PE_Blue
● 06PE_Red

SIZES S 35 - 39 / M 40 - 44 / L 45 - 48

PRICE € 15



00PE_BLACK



01PE_WHITE



00PE_BLACK



01PE_WHITE CORDA



03PE_MILITARY GREEN



14PE_BROWN

DARIO SOCKS FLAG



- DRY FAST & COMFORT
- SNUG FIT FOR SUPPORT
- REINFORCED TOE & HEEL
- MADE IN ITALY

20%PP DRYARN - 13%LENPUR - 53%PA - 13%CO - 1%EA

CODE 164WSFL

COLOR ● 00PE_Black
● 01PE_White

SIZES S 35 - 39 / M 40 - 44 / L 45 - 48

PRICE € 15

ELASTICA BELT



- STRETCH & ADJUSTABLE
- BROOKS SADDLE LEATHER INSERT
- REFLECTIVE DETAILS
- MADE IN ITALY

20%LT - 60%PO - 20%EL

CODE 154BEEL

COLOR ● 00PE_Black ● 01PE_White Corda
● 14PE_Brown ● 03PE_Military Green

SIZES 100 cm / 120 cm

PRICE € 79



00PE_BLACK 11PE_GREEN 13PE_BORDEAUX 14PE_BROWN

MIDO BOOTS



- WATER RESISTANT & BREATHABLE
- REFLECTIVE DETAILS
- ADDITIONAL 2 EXTRA LACES WITH REFLECTIVE
- MADE IN ITALY BY DIEMME

LEATHER AND RUBBER

CODE 15WSOWS
 COLOR ● 00PE_Black ● 13PE_Bordeaux
 ● 14PE_Brown ● 11PE_Green
 SIZES 39 / 40 / 41 / 42 / 43 / 44 / 45
 PRICE € 260



07PE_BLUE/SUADE 03PE_MIL. GREEN/SUADE

MIDO BOOTS



- WATER RESISTANT
- BREATHABLE
- REFLECTIVE DETAILS
- 2 EXTRA LACES
- MADE IN ITALY BY DIEMME

LEATHER AND RUBBER

CODE 17WSOWS
 COLOR ● 07PE_Blue ● 03PE_Military Green
 SIZES 39 / 40 / 41 / 42 / 43 / 44 / 45
 PRICE € 260



INTERNODE / 164ACBI



TENDRILL / 164ACBT



NODE / 164ACBN



CLUSTER 13 / 164ACBC

BIKE PACKING BAGS



- CONSTRUCTION HELPS KEEP YOU DRY AND COMFORTABLE
- ARCH BRIDGE FOR A SUPPORTIVE, COMPRESSION FIT
- SNUG, COMPRESSION FIT FOR SUPPORT AND COMFORT
- INSTEP MESH PANELS FOR VENTILATION
- REINFORCED TOE AND HEEL FOR DURABILITY IN HIGH-WEAR AREAS
- LOW-FRICTION CONSTRUCTION FOR REDUCED ABRASION OVER THE HEEL AND TOES
- SLIM FIT FOR PERFORMANCE
- MADE IN ITALY

76%CO - 11%PU - 6%AC - 7%PA

MODEL	CODE	COLOR	SIZE	MEASURE	PRICE
INTERNODE	164ACBI	● 09PE_Denim	M	46/52 cm x 12 cm - volumes 4 liter	€ 105
CLUSTER 13	164ACBC	● 09PE_Denim	U	15x18x19 cm - volume 13 liters	€ 145
TENDRILL	164ACBT	● 09PE_Denim	U	diameter 18 cm - length 35 to 65 cm volume 17 liters	€ 115
NODE	164ACBN	● 09PE_Denim	U	length 24 cm - height 12, 5 cm width 6,5 cm	€ 55

designed in japan / made in italy



WOMEN'S COLLECTION

☀️ SPRING/SUMMER ❄️ FALL/WINTER

PEdAL ED



NEW

HANE LIGHTWEIGHT JERSEY

REGULAR FIT DRY FAST REFLECTIVE DETAILS

- ULTRA LIGHTWEIGHT
- REFLECTIVE DETAILS
- MADE IN ITALY

74%PL - 26%EA



00PE_BLACK 10PE_PURPLE 01PE_WHITE

CODE W84JSHL
COLOR ● 00PE_Black ● 01PE_White
 ● 10PE_Purple
SIZES XXS / XS / S / M / L / XL
PRICE € 150



NEW

KAWA ESSENTIAL JERSEY

REGULAR FIT DRY FAST REFLECTIVE DETAILS

- UV PROTECTION FABRIC
- BREATHABLE
- DRY FAST
- STRETCH FABRIC
- MADE IN ITALY

73%PA - 27%EA



05PE_NAVY 17PE_CORAL RED 39PE_TURQUOISE

CODE W84JSKE
COLOR ● 05PE_Navy ● 39PE_Turquoise
 ● 17PE_Coral Red
SIZES XXS / XS / S / M / L / XL
PRICE € 125



NEW

HADA MERINO BASELAYER

THERMO REGULATION DRY FAST

- MERINO WOOL
- BREATHABLE
- THERMO REGULATION
- MADE IN ITALY

67%WOO - 22%PA - 11%EA



00PE_BLACK 17PE_CORAL RED 10PE_PURPLE

CODE W84JSMS
COLOR ● 00PE_Black ● 17PE_Coral Red
 ● 10PE_Purple
SIZES XXS / XS / S / M / L / XL
PRICE € 60



NEW

WOMEN ULTRALIGHT BSL

DRY FAST

- DRY FAST
- BREATHABLE
- MADE IN ITALY

89%PP - 11%EA

CODE W8SJSUS
COLOR ● 00PE_Black
SIZES XXS / XS / S / M / L / XL
PRICE € 48

00PE_BLACK



00PE_BLACK



01PE_WHITE

NEW **WOMAN VESPER VEST** 

- WINDPROOF
- REFLECTIVE DETAILS
- LIGHTWEIGHT GARMENT
- PACKABLE
- MADE IN ITALY

74%PL - 26%EA

CODE W8SVEVS
COLOR ● 00PE_Black
 ● 01PE_White
SIZES XXS / XS / S / M / L / XL
PRICE € 95



00PE_BLACK



01PE_WHITE

NEW **WOMAN VESPER JACKET**  

- WINDPROOF
- SLIMFIT FOR PERFORMANCE
- REFLECTIVE DETAILS
- LIGHTWEIGHT GARMENT
- PACKABLE
- MADE IN ITALY

73%PA - 27%EA

CODE W8WJKVS
COLOR ● 00PE_Black
 ● 01PE_White
SIZES XXS / XS / S / M / L / XL
PRICE € 108



00PE_BLACK

NEW **TSUKI BIBSHORT** 

- UV PROTECTION FABRIC
- LASERCUT AND TAPE SEAMS
- BREATHABLE
- DRY FAST
- CYTECH® PADDING
- STRETCH FABRIC
- MADE IN ITALY

67%WOO - 22%PA - 11%EA

CODE W84BBTS
COLOR ● 00PE_Black
SIZES XXS / XS / S / M / L / XL
PRICE € 180



00PE_BLACK

NEW **SHIZEN SHORTS** 

- UV PROTECTION FABRIC
- BREATHABLE
- DRY FAST
- CYTECH® PADDING
- STRETCH FABRIC
- MADE IN ITALY

89%PP - 11%EA

CODE W84BBSH
COLOR ● 00PE_Black
SIZES XXS / XS / S / M / L / XL
PRICE € 155



00PE_BLACK 01PE_WHITE 10PE_PURPLE 17PE_CORAL RED 05PE_NAVY 39PE_TURQUOISE

NEW **YUREI
REGULAR
SOCKS** ☀️

☑️ DRY FAST

- DRY FAST & COMFORT
- PERMANENT ANTIMICROBIAL PROPERTIES
- MADE IN ITALY

85%PA - 15%EL

CODE W84SRUY

COLOR ● 00PE_Black ● 10PE_Purple ● 17PE_Coral Red
● 01PE_White ● 05PE_Navy ● 39PE_Turquoise

SIZES S 35 - 38 / M 39 - 42

PRICE € 19



02PE_GREY

NEW **WOMAN
CYCLING
CAP** ☀️

☑️ REGULAR FIT ☑️ DRY FAST

- COMFORT FIT & LIGHTWEIGHT
- MADE IN ITALY

100% POLYESTER

CODE W84CASC

COLOR ● 02PE_Grey

SIZES UNIQUE

PRICE € 20



00PE_BLACK 01PE_WHITE

NEW **YUREI
SHORT
SOCKS** ☀️

☑️ DRY FAST

- DRY FAST & COMFORT
- PERMANENT ANTIMICROBIAL PROPERTIES
- MADE IN ITALY

85%PA - 15%EL

CODE W8SSSYU

COLOR ● 00PE_Black ● 01PE_White

SIZES S 35 - 38 / M 39 - 42

PRICE € 14







SADDLES

FLEX + ROTATE

Sin dalla presentazione dello Spine Concept nel 2008 fi'zi:k, in collaborazione con gli atleti professionisti e l'Univeristà del Colorado ha studiato a fondo la biomeccanica del ciclismo e la sua relazione con la performance e il comfort. L'evoluzione del legame tra atleta e mezzo è sintetizzata nello Spine Concept EVO.

La création en 2008 par fi'zi:k du Spine Concept, est le fruit de longues études menées en collaboration avec des cyclistes professionnels et l'Université du Colorado, dans le but de comprendre la biomécanique du cycliste par rapport au confort et à la performance. Le Spine Concept EVO est la connection entre l'homme et sa machine.

SPINE
CONCEPT
E V O

FLESSIBILITÀ + ROTAZIONE. La flessibilità del dorso e la rotazione del bacino sono intrinsecamente legate alla scelta della sella giusta.

SOUPLESSE + ROTATION. La souplesse de la colonne vertébrale et la rotation pelvienne sont directement liées au confort de la selle et déterminent le modèle le mieux adapté à chaque cycliste.



SNAKE

Flessibilità alta e nessuna rotazione pelvica durante la pedalata. Hai bisogno di una sella con profilo piatto. Grande souplesse et aucune rotation, vous avez besoin de cette selle.

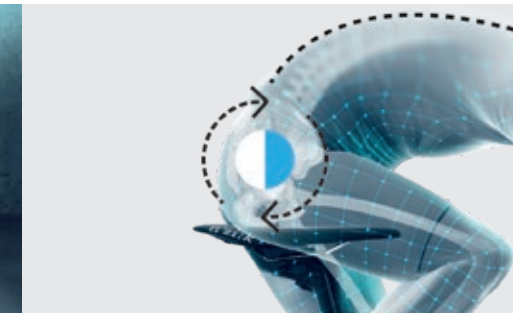

BULL

Flessibilità scarsa e alta rotazione pelvica durante la pedalata. Hai bisogno di una sella con profilo curvo. Peu de souplesse et bonne rotation du bassin, vous avez besoin de cette selle.

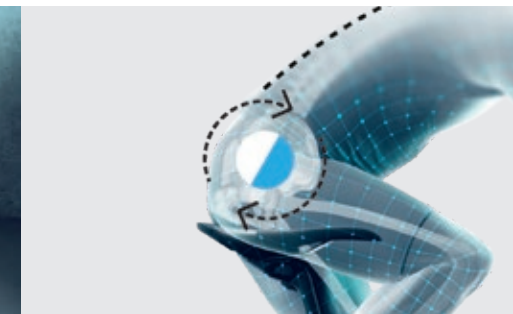

CHAMELEON

Flessibilità media e bassa rotazione pelvica durante la pedalata. Hai bisogno di una sella con profilo intermedio. Peu de souplesse et de rotation, vous avez besoin de cette selle.



WEIGHT + SPEED

PESO + VELOCITÀ. Il tuo peso e la tua potenza in bicicletta determinano la tua taglia di sella: **Regular** o **Large**.

POIDS + VITESSE. Le poids du corps et la puissance développée déterminent la largeur de votre selle, **Regular** ou **Large**.

80 kg

Il tuo peso / Votre poids

20 km/h

La tua velocità media su una strada piana / Votre vitesse moyenne

79 w / 33.9 kg

Output potenza - Peso sulla sella / Puissance développée - Poids sur la selle

LARGE

La tua taglia / Votre largeur conseillée

TWO SIZES

DUE TAGLIE / DEUX TAILLES



132 mm
Arione Regular



142 mm
Arione Large



142 mm
Aliante Regular



152 mm
Aliante Large



140 mm
Antares Regular



152 mm
Antares Large

FIND YOUR SIZE

TROVA LA TUA TAGLIA. Seleziona il tuo peso e la tua velocità media per determinare i Watt che esprimi in bici e quindi la taglia di sella raccomandata per te.

TROUVEZ VOTRE MODELE. Sélectionnez votre poids et la vitesse moyenne qui déterminent la puissance développée et donc le modèle de selle conseillée.



Assieme al display **Spine Concept EVO**, fi'zi:k ha sviluppato una App pensata per aiutare il consumatore in negozio. Come scaricare e usare la App? Semplicemente visita l'App Store di iTunes (per dispositivi iOS) o il Google Play Store (per dispositivi Android), cerca le parole chiave: **spine concept evo e/o fi'zi:k** e scarica l'App.

Avec le display **Spine concept EVO**, fi'zi:k a développé une application spécifique Spine Concept EVO afin de vous accompagner et vous assister dans les ventes auprès de votre clientèle. Comment la télécharger et l'utiliser? Il suffit de visiter l'App Store iTunes (iOS) ou Google Play Store (Android) et chercher les mots clés: **spine concept.evo et/ou fi'zi:k**, puis télécharger.

Taglia raccomandata/Taille préconisée: **Regular**
 Taglia raccomandata/Taille préconisée: **Large**

Speed in km/h	20	21	22	23	24	25	26	27	28	29	30	31	32	33	34	35	36	37	38	39	40	41	42	43	44	45
Speed in mph	12.5	13	13.6	14.3	14.9	15.5	16	16.7	17.4	18	18.6	19.2	19.9	20.5	21	21.7	22.4	23	23.5	24	25	25.5	26	26.5	27.3	28
45 kg	64W 18.4kg	71W 18.2kg	78W 18.0kg	86W 17.7kg	95W 17.4kg	104W 17.1kg	114W 16.8kg	125W 16.4kg	137W 16.1kg	149W 15.7kg	162W 15.3kg	174W 14.8kg	190W 14.3kg	205W 13.8kg	222W 13.3kg	239W 12.8kg	257W 12.2kg	276W 11.6kg	296W 10.9kg	317W 10.2kg	339W 9.5kg	362W 8.8kg	387W 8.0kg	412W 7.1kg	438W 6.3kg	466W 5.4kg
50 kg	66W 20.6kg	74W 20.4kg	81W 20.1kg	89W 19.9kg	98W 19.6kg	108W 19.3kg	118W 19.0kg	129W 18.6kg	140W 18.3kg	153W 17.8kg	166W 17.4kg	180W 17.0kg	194W 16.5kg	210W 16.0kg	226W 15.4kg	244W 14.9kg	262W 14.3kg	281W 13.7kg	301W 13.0kg	323W 12.3kg	345W 11.6kg	368W 10.9kg	392W 10.1kg	418W 9.2kg	444W 8.4kg	472W 7.5kg
55 kg	69W 22.8kg	76W 22.6kg	84W 22.3kg	93W 22.1kg	102W 21.8kg	111W 21.4kg	122W 21.1kg	133W 20.8kg	144W 20.4kg	157W 20.0kg	170W 19.5kg	184W 19.1kg	199W 18.6kg	214W 18.1kg	231W 17.6kg	248W 17.0kg	267W 16.4kg	286W 15.8kg	306W 15.1kg	328W 14.4kg	350W 13.7kg	374W 12.9kg	398W 12.2kg	424W 11.3kg	450W 10.5kg	478W 9.6kg
60 kg	72W 25.0kg	79W 24.8kg	87W 24.5kg	96W 24.2kg	105W 23.9kg	115W 23.6kg	125W 23.3kg	136W 22.9kg	148W 22.5kg	161W 22.1kg	174W 21.7kg	188W 21.2kg	203W 20.7kg	219W 20.2kg	236W 19.7kg	253W 19.1kg	272W 18.5kg	291W 17.9kg	312W 17.2kg	333W 16.5kg	356W 15.8kg	379W 15.0kg	404W 14.2kg	430W 13.4kg	456W 12.5kg	485W 11.6kg
65 kg	75W 27.2kg	82W 26.9kg	90W 26.7kg	99W 26.4kg	108W 26.1kg	118W 25.8kg	129W 25.4kg	140W 25.1kg	152W 24.7kg	165W 24.3kg	178W 23.8kg	192W 23.4kg	207W 22.9kg	223W 22.4kg	240W 21.8kg	258W 21.2kg	277W 20.6kg	296W 20.0kg	317W 19.3kg	338W 18.6kg	361W 17.9kg	385W 17.1kg	410W 16.3kg	435W 15.5kg	462W 14.6kg	491W 13.7kg
70 kg	77W 29.4kg	85W 29.1kg	93W 28.9kg	102W 28.6kg	111W 28.3kg	121W 28.0kg	132W 27.6kg	144W 27.2kg	156W 26.8kg	169W 26.4kg	182W 26.0kg	197W 25.5kg	212W 25.0kg	228W 24.5kg	245W 24.0kg	263W 23.4kg	282W 22.8kg	301W 22.1kg	322W 21.5kg	344W 20.7kg	367W 20.0kg	390W 19.2kg	415W 18.4kg	441W 17.6kg	468W 16.7kg	497W 15.8kg
75 kg	80W 31.6kg	88W 31.3kg	96W 31.0kg	105W 30.8kg	115W 30.4kg	125W 30.1kg	136W 29.8kg	147W 29.4kg	159W 29.0kg	172W 28.6kg	186W 28.1kg	201W 27.7kg	216W 27.2kg	232W 26.6kg	250W 26.1kg	268W 25.5kg	286W 24.9kg	306W 24.2kg	327W 23.6kg	349W 22.9kg	372W 22.1kg	396W 21.3kg	421W 20.5kg	447W 19.7kg	474W 18.8kg	503W 17.9kg
80 kg	83W 33.8kg	91W 33.5kg	99W 33.2kg	108W 32.9kg	118W 32.6kg	128W 32.3kg	139W 31.9kg	151W 31.6kg	163W 31.1kg	176W 30.7kg	190W 30.3kg	205W 29.8kg	221W 29.3kg	237W 28.8kg	254W 28.2kg	272W 27.6kg	291W 27.0kg	311W 26.4kg	332W 25.7kg	354W 25.0kg	377W 24.2kg	402W 23.4kg	427W 22.6kg	453W 21.8kg	480W 20.9kg	509W 19.9kg
85 kg	85W 35.9kg	94W 35.7kg	102W 35.4kg	111W 35.1kg	121W 34.8kg	132W 34.5kg	143W 34.1kg	155W 33.7kg	167W 33.3kg	180W 32.9kg	194W 32.4kg	209W 31.9kg	225W 31.4kg	241W 30.9kg	259W 30.3kg	277W 29.7kg	296W 29.1kg	316W 28.5kg	338W 27.8kg	360W 27.1kg	383W 26.3kg	407W 25.5kg	432W 24.7kg	459W 23.9kg	486W 23.0kg	515W 22.0kg
90 kg	88W 38.1kg	96W 37.9kg	105W 37.6kg	115W 37.3kg	124W 37.0kg	135W 36.6kg	146W 36.3kg	158W 35.9kg	171W 35.5kg	184W 35.0kg	199W 34.6kg	213W 34.1kg	229W 33.6kg	246W 33.0kg	263W 32.5kg	282W 31.9kg	301W 31.2kg	321W 30.6kg	343W 29.9kg	365W 29.2kg	388W 28.4kg	413W 27.6kg	438W 26.8kg	465W 25.9kg	492W 25.0kg	521W 24.1kg
95 kg	91W 40.3kg	99W 40.1kg	108W 39.8kg	118W 39.5kg	128W 39.2kg	138W 38.8kg	150W 38.4kg	162W 38.0kg	175W 37.6kg	188W 37.2kg	203W 36.7kg	218W 36.2kg	234W 35.7kg	250W 35.2kg	268W 34.6kg	287W 34.0kg	306W 33.4kg	327W 32.7kg	348W 32.0kg	370W 31.3kg	394W 30.5kg	418W 29.7kg	444W 28.9kg	471W 28.0kg	498W 27.1kg	527W 26.2kg
100 kg	94W 42.5kg	102W 42.4kg	110W 42.1kg	119W 41.8kg	129W 41.5kg	139W 41.1kg	150W 40.7kg	162W 40.4kg	175W 39.9kg	188W 39.5kg	203W 39.0kg	218W 38.6kg	234W 38.0kg	250W 37.5kg	268W 36.9kg	286W 36.3kg	304W 35.7kg	324W 35.0kg	346W 34.3kg	368W 33.6kg	392W 32.9kg	416W 32.1kg	442W 31.2kg	468W 30.4kg	496W 29.5kg	525W 28.5kg
110 kg	99W 46.9kg	108W 46.6kg	117W 46.3kg	127W 46.0kg	137W 45.6kg	147W 45.3kg	158W 44.9kg	169W 44.5kg	181W 44.1kg	194W 43.6kg	208W 43.1kg	223W 42.6kg	239W 42.1kg	255W 41.6kg	272W 41.0kg	290W 40.4kg	309W 39.7kg	328W 39.0kg	348W 38.3kg	368W 37.6kg	388W 36.8kg	410W 36.0kg	435W 35.2kg	461W 34.3kg	488W 33.4kg	516W 32.4kg
120 kg	105W 51.3kg	114W 51.0kg	123W 50.7kg	133W 50.3kg	144W 50.0kg	156W 49.6kg	168W 49.2kg	180W 48.8kg	194W 48.4kg	208W 47.9kg	223W 47.4kg	239W 46.9kg	255W 46.4kg	273W 45.8kg	291W 45.2kg	310W 44.6kg	331W 43.9kg	352W 43.3kg	374W 42.5kg	397W 41.8kg	421W 41.0kg	446W 40.2kg	472W 39.4kg	500W 38.5kg	528W 37.5kg	558W 36.6kg

SPINE CONCEPT EVO

31.7 kg
Bodyweight on saddle
Rider 75 kg
Power Output 1 w/kg

40%
Bodyweight distribution
Rider 75 kg
Power Output 2 w/kg

15%
Bodyweight distribution
Rider 75 kg
Power Output 3.5 w/kg

25.7 kg
Bodyweight on saddle
Rider 75 kg
Power Output 3.5 w/kg

SURFACE CHOICE

La scelta della sella è personale, per questo riteniamo che il consumatore meriti di avere la possibilità di scegliere la superficie che preferisce.

Chaque selle doit être personnelle. Avoir la possibilité de pouvoir choisir le type de coque est une option que nous offrons à chaque cycliste.

SOLID

Le selle **Solid** sono da anni scelte e approvate dai professionisti per la loro performance. Questa costruzione, fatta a mano, offre rigidità per un ottimale trasferimento della potenza combinata con un'imbottitura resiliente per la migliore distribuzione del peso del corpo.

Les selles à coque **Solid** démontrent à travers leur présence au sein du peloton de leurs aptitudes à la performance en compétition. Cette fabrication "à la main" se caractérise par une structure ayant pour capacité de transmettre la puissance du cycliste tout en s'associant à un rembourrage dont la qualité permet une distribution parfaite du poids du corps.

VERSUS EVO

Le selle **Versus Evo** sono studiate per completare le moderne biciclette multiuso. L'elasticità controllata dello scafo e l'ammortizzazione progressiva permettono al ciclista di pedalare comodamente su qualunque terreno e per lunghe distanze.

Les **Versus Evo** sont des selles conçues pour compléter une offre polyvalente, efficace et multi usage, pour tout type de vélo de route. L'élasticité de la coque associée à un rembourrage à haute capacité d'amortissement procurent au cycliste le confort qu'il attend sur les longues distances et pour les parcours les plus variés.

OPEN

Le selle **Open** sono selle performanti con un foro centrale per alleviare la pressione nella zona perineale. Questa costruzione, fatta a mano, offre rigidità per un ottimale trasferimento della potenza combinata con un'imbottitura resiliente e un foro centrale per scaricare la pressione dai tessuti molli.

Les **Open** sont des selles construites avec une partie centrale découpée afin de soulager la pression périnéale. Cette fabrication "à la main" se caractérise par une structure permettant de transmettre la puissance maximum du cycliste tout en s'associant à un rembourrage à haute capacité d'absorption plus une découpe centrale ayant pour effet de soulager la pression au niveau des zones sensibles.



Arione
Made for Snake



Antares
Made for Chameleon



Aliante
Made for Bull



**Arione 00**
Made for Snake

length 298 | width 124 mm



code	EAN	color (main/trim)	rail	shell	tech	weight	SRP
7092SWSA19C65	8021890428127	Black/Anthracite	Carbon Braided 7x9 Mobius	Carbon double	Wing Flex	140 g	350 €

**Arione R1**
Made for SnakeRegular | length 304 | width 126 mm
Large | length 300 | width 140 mm

code	EAN	color (main/trim)	rail	shell	tech	weight	SRP
76B5SWSA09C65	8021890443861	Black/Black	Carbon Braided 7x9	Composite Carbon co-injected Nylon	Wing Flex	165 g	199 €
76B0SWSA09E12	8021890443830	Black/Black	Carbon Braided 7x9	Composite Carbon co-injected Nylon	Wing Flex	175 g	199 €

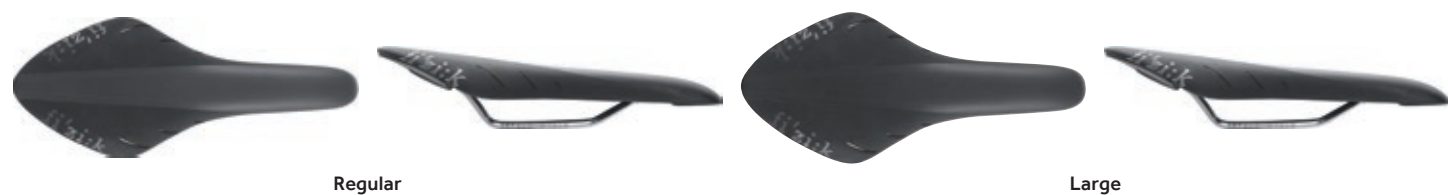
**Arione R3**
Made for SnakeRegular | length 304 | width 126 mm
Large | length 300 | width 141 mm

code	EAN	color (main/trim)	rail	shell	tech	weight	SRP
74B5SWSA09F04	8021890443816	Black/Black/White	k:iium	Composite Glass co-injected Nylon	Wing Flex	200 g	149 €
74B0SWSA09C65	8021890443786	Black/Black/White	k:iium	Composite Glass co-injected Nylon	Wing Flex	210 g	149 €

**Arione**
Made for Snake

length 302 | width 131 mm



code	EAN	color (main/trim)	rail	shell	tech	weight	SRP
7014XSXD99640	8021890276308	Alcantara Black/Black	k:iium	Carbon Reinforced Nylon	Wing Flex	235 g	129 €

**Arione 00 Versus EVO** **NEW**
Made for SnakeRegular | length 299 | width 130 mm
Large | length 299 | width 140 mm

code	EAN	color (main/trim)	rail	shell	tech	weight	SRP
77A4SOSA03A23	8021890469175	Black	Carbon Braided 7x9 Mobius	High Module Full Carbon	Wing Flex	166 g	350 €
77D4SOSA03A23	8021890469205	Black	Carbon Braided 7x9 Mobius	High Module Full Carbon	Wing Flex	169 g	350 €

**Arione R1 Versus EVO**
Made for SnakeRegular | length 299 | width 130 mm
Large | length 299 | width 139 mm

code	EAN	color (main/trim)	rail	shell	tech	weight	SRP
70A4SOSA03A02	8021890455574	Black	Carbon Braided 7x9 Mobius	Carbon Reinforced Nylon	Wing Flex	185 g	210 €
70D4SOSA03A02	8021890455765	Black	Carbon Braided 7x9 Mobius	Carbon Reinforced Nylon	Wing Flex	189 g	210 €

**Arione R3 Versus EVO**
Made for SnakeRegular | length 299 | width 129 mm
Large | length 297 | width 140 mm

code	EAN	color (main/trim)	rail	shell	tech	weight	SRP
70A4SOSA13041	8021890455581	Black	k:iium	Carbon Reinforced Nylon	Wing Flex	225 g	160 €
70D4SOSA13041	8021890455772	Black	k:iium	Carbon Reinforced Nylon	Wing Flex	229 g	160 €

ROAD



Arione R1 Open
Made for Snake

Regular | lenght 300 | width 132 mm
Large | lenght 298 | width 142 mm



code	EAN	color (main/trim)	rail	shell	tech	weight	SRP
70C0S A03A02	8021890455642	Black	Carbon Braided 7x9 Mobius	Carbon Reinforced Nylon	Wing Flex	199 g	179 €
70D0S A03A02	8021890455703	Black	Carbon Braided 7x9 Mobius	Carbon Reinforced Nylon	Wing Flex	205 g	179 €



Arione R3 Open
Made for Snake



code	EAN	color (main/trim)	rail	shell	tech	weight	SRP
70C0S A13041	8021890455659	Black	k:i:um	Carbon Reinforced Nylon	Wing Flex	230 g	139 €
70D0S A13041	8021890455710	Black	k:i:um	Carbon Reinforced Nylon	Wing Flex	240 g	139 €
NEW 70C0S A13038	8021890460233	White Edition	k:i:um	Carbon Reinforced Nylon	Wing Flex	230 g	139 €
NEW 70D0S A13038	8021890460264	White Edition	k:i:um	Carbon Reinforced Nylon	Wing Flex	240 g	139 €



**Antares 00**
Made for Chameleon

length 275 | width 140 mm



code	EAN	color (main/trim)	rail	shell	tech	weight	SRP
7091SWSA19C65	8021890428103	Black/Anthracite	Carbon Braided 7x9 Mobius	Carbon double	Wing Flex	140 g	350 €

**Antares R1**
Made for ChameleonRegular | length 275 | width 141 mm
Large | length 275 | width 152 mm

code	EAN	color (main/trim)	rail	shell	tech	weight	SRP
7683SXSA69E12	8021890443878	Black/Black	Carbon Braided 7x9	Composite Carbon co-injected Nylon	Wing Flex	160 g	199 €
76B1SXSA09C65	8021890443847	Black/Black	Carbon Braided 7x9	Composite Carbon co-injected Nylon	Wing Flex	165 g	199 €

**Antares R3**
Made for Chameleon

code	EAN	color (main/trim)	rail	shell	tech	weight	SRP
7483SXSB89H16	8021890443823	Black/Black	k:i:um	Composite Glass co-injected Nylon	Wing Flex	200 g	149 €
74B1SXSA09C65	8021890443793	Black/Black	k:i:um	Composite Glass co-injected Nylon	Wing Flex	205 g	149 €

**Antares 00 Versus EVO** **NEW**
Made for ChameleonRegular | length 274,5 | width 137,5 mm
Large | length 274 | width 147 mm

code	EAN	color (main/trim)	rail	shell	tech	weight	SRP
77A5SOSA03A23	8021890469182	Black	Carbon Braided 7x9 Mobius	High Module Full Carbon	Wing Flex	153 g	350 €
77D5SOSA03A23	8021890469212	Black	Carbon Braided 7x9 Mobius	High Module Full Carbon	Wing Flex	159 g	350 €

**Antares R1 Versus EVO**
Made for ChameleonRegular | length 273 | width 139 mm
Large | length 275 | width 149 mm

code	EAN	color (main/trim)	rail	shell	tech	weight	SRP
70A5SOSA03A02	8021890455598	Black	Carbon Braided 7x9 Mobius	Carbon Reinforced Nylon	Wing Flex	179 g	210 €
70D5SOSA03A02	8021890455789	Black	Carbon Braided 7x9 Mobius	Carbon Reinforced Nylon	Wing Flex	185 g	210 €

**Antares R3 Versus EVO**
Made for ChameleonRegular | length 274 | width 139 mm
Large | length 274 | width 148 mm

code	EAN	color (main/trim)	rail	shell	tech	weight	SRP
70A5SOSA13041	8021890455604	Black	k:i:um	Carbon Reinforced Nylon	Wing Flex	215 g	160 €
70D5SOSA13041	8021890455796	Black	k:i:um	Carbon Reinforced Nylon	Wing Flex	220 g	160 €

ROAD



Antares R1 Open
Made for Chameleon

Regular | length 276 | width 141 mm
Large | length 276 | width 153 mm



code	EAN	color (main/trim)	rail	shell	tech	weight	SRP
70C1S A03A02	8021890455666	Black	Carbon Braided 7x9 Mobius	Carbon Reinforced Nylon	Wing Flex	185 g	179 €
70D1S A03A02	8021890455727	Black	Carbon Braided 7x9 Mobius	Carbon Reinforced Nylon	Wing Flex	190 g	179 €



Antares R3 Open
Made for Chameleon

Regular | length 276 | width 142 mm
Large | length 276 | width 153 mm



code	EAN	color (main/trim)	rail	shell	tech	weight	SRP
70C1S A13041	8021890455673	Black	k:i:um	Carbon Reinforced Nylon	Wing Flex	215 g	139 €
70D1S A13041	8021890455734	Black	k:i:um	Carbon Reinforced Nylon	Wing Flex	220 g	139 €
NEW 70C1S A13038	8021890460240	White Edition	k:i:um	Carbon Reinforced Nylon	Wing Flex	215 g	139 €
NEW 70D1S A13038	8021890460288	White Edition	k:i:um	Carbon Reinforced Nylon	Wing Flex	220 g	139 €



ROAD



Aliante 00
Made for Bull

length 277 | width 134 mm



code	EAN	color (main/trim)	rail	shell	tech	weight	SRP
7093SWSA19C65	8021890428141	Black/Anthracite	Carbon Braided 7x9 Mobius	Carbon double	Wing Flex	165 g	350 €



Aliante R1
Made for Bull

Regular | length 279 | width 138 mm
Large | length 279 | width 154 mm



code	EAN	color (main/trim)	rail	shell	tech	weight	SRP
7680SWSA09F75	8021890411280	Black/Black	Carbon Braided 7x9	Composite Carbon co-injected Nylon	Twin Flex	175 g	199 €
76B2SWSA09F81	8021890443854	Black/Black	Carbon Braided 7x9	Composite Carbon co-injected Nylon	Twin Flex	180 g	199 €



Aliante R3
Made for Bull

Regular | length 279 | width 138 mm
Large | length 279 | width 155 mm



code	EAN	color (main/trim)	rail	shell	tech	weight	SRP
7480SWSA79F82	8021890444080	Black/Black	k:i:um	Composite Glass co-injected Nylon	Twin Flex	215 g	149 €
74B2SWSA09F75	8021890443809	Black/Black	k:i:um	Composite Glass co-injected Nylon	Twin Flex	220 g	149 €



Aliante Gamma
Made for Bull

length 266 | width 141 mm



code	EAN	color (main/trim)	rail	shell	tech	weight	SRP
7018SWSA49A62	8021890348371	Black/White	k:i:um	Carbon Reinforced Nylon	Twin Flex	255 g	129 €

ROAD



Aliante 00 Versus EVO **NEW**
Made for Bull

Regular | length 281,5 | width 135,5 mm
Large | length 281,5 | width 150 mm



code	EAN	color (main/trim)	rail	shell	tech	weight	SRP
77A6SOSA03A23	8021890469199	Black	Carbon Braided 7x9 Mobius	High Module Full Carbon	Wing Flex	163 g	350 €
77D6SOSA03A23	8021890469229	Black	Carbon Braided 7x9 Mobius	High Module Full Carbon	Wing Flex	169 g	350 €



Aliante R1 Versus EVO
Made for Bull

Regular | length 280 | width 139 mm
Large | length 280 | width 169 mm



code	EAN	color (main/trim)	rail	shell	tech	weight	SRP
70A6SOSA03A02	8021890455611	Black	Carbon Braided 7x9 Mobius	Carbon Reinforced Nylon	Wing Flex	189 g	210 €
70D6SOSA03A02	8021890455802	Black	Carbon Braided 7x9 Mobius	Carbon Reinforced Nylon	Wing Flex	195 g	210 €



Aliante R3 Versus EVO
Made for Bull

Regular | length 280 | width 139 mm
Large | length 279 | width 153 mm



code	EAN	color (main/trim)	rail	shell	tech	weight	SRP
70A6SOSA13041	8021890455628	Black	k:i:um	Carbon Reinforced Nylon	Wing Flex	229 g	160 €
70D6SOSA13041	8021890455819	Black	k:i:um	Carbon Reinforced Nylon	Wing Flex	235 g	160 €

ROAD



Aliante R1 Open
Made for Bull

Regular | lenght 276 | width 141 mm
Large | lenght 275 | width 153 mm



code	EAN	color (main/trim)	rail	shell	tech	weight	SRP
70C2S A03A02	8021890455680	Black	Carbon Braided 7x9 Mobius	Carbon Reinforced Nylon	Wing Flex	199 g	179 €
70D2S A03A02	8021890455741	Black	Carbon Braided 7x9 Mobius	Carbon Reinforced Nylon	Wing Flex	205 g	179 €



Aliante R3 Open
Made for Bull

Regular | lenght 278 | width 142 mm
Large | lenght 278 | width 152 mm



code	EAN	color (main/trim)	rail	shell	tech	weight	SRP
70C2S A13041	8021890455697	Black	k:i:um	Carbon Reinforced Nylon	Wing Flex	235 g	139 €
70D2S A13041	8021890455758	Black	k:i:um	Carbon Reinforced Nylon	Wing Flex	245 g	139 €
NEW 70C2S A13038	8021890460257	White Edition	k:i:um	Carbon Reinforced Nylon	Wing Flex	235 g	139 €
NEW 70D2S A13038	8021890460301	White Edition	k:i:um	Carbon Reinforced Nylon	Wing Flex	245 g	139 €



X-ROAD

MONTE Made for Enduro

length 277 | width 143 mm



code	EAN	color (main/trim)	rail	shell	tech	weight	SRP
70A0SXCA29878	8021890443885	Black/Black Cordura	S-Alloy	Carbon Reinforced Nylon	Tail Flex	250 g	79 €

Tundra M1 Made for Cross Country

length 287 | width 126 mm



code	EAN	color (main/trim)	rail	shell	tech	weight	SRP
7682SWSA09E12	8021890391568	Black/Black	Carbon Braided 7x9	Composite Carbon co-injected Nylon	Wing Flex	160 g	199 €

Tundra M3 Made for Cross Country

length 286 | width 126 mm



code	EAN	color (main/trim)	rail	shell	tech	weight	SRP
7482SWSA69C65	8021890448132	Black/Grey	k:i:um	Composite Glass co-injected Nylon	Wing Flex	200 g	149 €

Tundra M5 VS Made for Cross Country

length 287 | width 126 mm



code	EAN	color (main/trim)	rail	shell	tech	weight	SRP
7094SXCA29878	8021890443991	Black/Silver	S-Alloy	Carbon Reinforced Nylon	Wing Flex	235 g	99 €

X-ROAD

Gobi M1 Made for All Mountain and Marathon

length 286 | width 128 mm



code	EAN	color (main/trim)	rail	shell	tech	weight	SRP
7665SWSA09G02	8021890413802	Black/Black	Carbon Braided 7x9	Composite Carbon	Wing Flex, Tail Flex	170 g	199 €

Gobi M3 Made for All Mountain and Marathon



code	EAN	color (main/trim)	rail	shell	tech	weight	SRP
7465SWSA39G04	8021890444073	Black/Grey	k:i:um	Composite Glass co-injected Nylon	Wing Flex, Tail Flex	200 g	149 €

Gobi M5 VS Made for All Mountain and Marathon



code	EAN	color (main/trim)	rail	shell	tech	weight	SRP
7096SXCA29878	8021890444004	Black/Silver	S-Alloy	Carbon Reinforced Nylon	Wing Flex, Tail Flex	240 g	99 €

TRANSIRO

Transiro Mistica Carbon + CARRIAGE KIT



NEW

Regular | width 134 mm | width nose 55 mm
Large | width 139 mm | width nose 65 mm



Regular



Large



code	EAN	color (main/trim)	rail	shell	tech	weight	SRP
70B6SWSA29H20	8021890468925	Black/White	Carbon Braided 7x9	Carbon Reinforced Nylon, extra grip cover	Nose less	205 g	250 €
70B7SWSA29H20	8021890468949	Black/White	Carbon Braided 7x9	Carbon Reinforced Nylon, extra grip cover	Nose less	215 g	250 €

Transiro Mistica k:i:um + CARRIAGE KIT



NEW



Regular



Large



code	EAN	color (main/trim)	rail	shell	tech	weight	SRP
70B6SWSA39H19	8021890468932	Black/Black	k:i:um	Carbon Reinforced Nylon, extra grip cover	Nose less	235 g	179 €
70B7SWSA39H19	8021890468956	Black/Black	k:i:um	Carbon Reinforced Nylon, extra grip cover	Nose less	245 g	179 €



WOMEN

Luce R1

Made for Road

Regular | lenght 280 | width 145 mm
Large | lenght 281 | width 155 mm



code	EAN	color (main/trim)	rail	shell	tech	weight	SRP
70B3SWSA39E12	8021890455994	Black	Carbon Braided 7x9	Carbon Reinforced Nylon	Ischial Flex	195 g	179 €
70B4SWSA39E12	8021890456014	Black	Carbon Braided 7x9	Carbon Reinforced Nylon	Ischial Flex	199 g	179 €

Luce R5

Made for Road

Regular | lenght 281 | width 145 mm
Large | lenght 281 | width 156 mm



code	EAN	color (main/trim)	rail	shell	tech	weight	SRP
70B3SWSA49C65	8021890456007	Black	S-Alloy	Carbon Reinforced Nylon	Ischial Flex	250 g	99 €
70B4SWSA49C65	8021890456021	Black	S-Alloy	Carbon Reinforced Nylon	Ischial Flex	255 g	99 €

Luna X5

Made for MTB

Regular | lenght 281 | width 145 mm
Large | lenght 281 | width 156 mm



code	EAN	color (main/trim)	rail	shell	tech	weight	SRP
70C7SWSA09604	8021890456038	Black	S-Alloy	Carbon Reinforced Nylon	Ischial Flex	255 g	99 €
70C8SWSA09604	8021890456045	Black	S-Alloy	Carbon Reinforced Nylon	Ischial Flex	260 g	99 €





INFINITO—R1 PERFECT. PERFECTED.

La scarpa Infinito R1 offre un comfort di altissimo livello e un supporto ottimale durante la pedalata grazie al Dynamic Arch Support che adatta la calzata al tipo di piede.

La chaussure Infinito R1 offre un confort de haut niveau et un maintien optimal pendant le pédalage grâce au Dynamic Arch Support et au Volume Control.

SHOES

fi'zi:k

ROAD

Infinito R1 Movistar Team



code	EAN	size	color	outsole	insole	closure	upper material	SRP
R1INFIN18-MO43	Various	37-47	Movistar Light Blue	UD Vented Carbon	fi'zi:k Cycling Insole	Boa IP1-B	Microtex Laser Perforated	380 €

Infinito R1 Knit



code	EAN	size	color	outsole	insole	closure	upper material	SRP
R1INFIN18-1060	Various	37-48	Black Knitted	UD Vented Carbon	fi'zi:k Cycling Insole	Boa IP1-B	Knitted	380 €
NEW R1INFIN18-7310	Various	40-46	Grey Knit/Black	UD Vented Carbon	fi'zi:k Cycling Insole	Boa IP1-B	Knitted	380 €
NEW R1INFIN18-4490	Various	40-46	Petroleum Blue Knit/ Yellow Fluo	UD Vented Carbon	fi'zi:k Cycling Insole	Boa IP1-B	Knitted	380 €

Infinito R1



code	EAN	size	color	outsole	insole	closure	upper material	SRP
R1INFIN18-1010	Various	37-48	Black/Black	UD Vented Carbon	fi'zi:k Cycling Insole	Boa IP1-B	Microtex Laser Perforated	350 €
R1INFIN18-2010	Various	37-48	White/Black	UD Vented Carbon	fi'zi:k Cycling Insole	Boa IP1-B	Microtex Laser Perforated	350 €
R1INFIN18-3010	Various	37-48	Red/Black	UD Vented Carbon	fi'zi:k Cycling Insole	Boa IP1-B	Microtex Laser Perforated	350 €



Aria R3



code	EAN	size	color	outsole	insole	closure	upper material	SRP
R3ARIA18-1010	Various	36-48	Black/Black	UD Carbon	fi'zi:k Cycling Insole	Boa IP1-B	Microtex Laser Perforated	275 €
R3ARIA18-2010	Various	36-48	White/Black	UD Carbon	fi'zi:k Cycling Insole	Boa IP1-B	Microtex Laser Perforated	275 €
R3ARIA18-1030	Various	36-48	Black/Red	UD Carbon	fi'zi:k Cycling Insole	Boa IP1-B	Microtex Laser Perforated	275 €
R3ARIA18-1090	Various	36-48	Black/Yellow Fluo	UD Carbon	fi'zi:k Cycling Insole	Boa IP1-B	Microtex Laser Perforated	275 €

R4B



code	EAN	size	color	outsole	insole	closure	upper material	SRP
R4MCA-BC-1020	Various	36-48	Black/White	Carbon injected	fi'zi:k Cycling Insole	Boa IP1-A	Microtex Laser Perforated	200 €
R4MCA-BC-1030	Various	40-48	Black/Red	Carbon injected	fi'zi:k Cycling Insole	Boa IP1-A	Microtex Laser Perforated	200 €
R4MCA-BC-2010	Various	40-48	White/Black	Carbon injected	fi'zi:k Cycling Insole	Boa IP1-A	Microtex Laser Perforated	200 €
R4MCA-BC-4210	Various	36-48	Navy/Black	Carbon injected	fi'zi:k Cycling Insole	Boa IP1-A	Microtex Laser Perforated	200 €

R4B
DONNA

code	EAN	size	color	outsole	insole	closure	upper material	SRP
R4WCA-BC-2052	Various	36-43	White/Emerald Green	Carbon injected	fi'zi:k Cycling Insole	Boa IP1-A	Microtex Laser Perforated	200 €

Artica R5 Winter Road Shoes With Bootie



code	EAN	size	color	outsole	insole	closure	upper material	SRP
R5ARTIC18-1010	Various	40-48	Black	Carbon Composite Ventilated	fi'zi:k Cycling Insole	Internal Speed Lacing system	Microtex Reinforced Shell	200 €

Tempo R5 Overcurve **NEW**

code	EAN	size	color	outsole	insole	closure	upper material	SRP
TPR5OCMI1-1010	Various	36-48	Black/Black	Carbon Reinforced Nylon	fi'zi:k Cycling Insole	Boa IP1-B	Microtex/Reflective Heel Cap	149 €
TPR5OCMI1-2010	Various	36-48	White/Black	Carbon Reinforced Nylon	fi'zi:k Cycling Insole	Boa IP1-B	Microtex/Reflective Heel Cap	149 €
TPR5OCMI1-1092	Various	36-42	Black/Pink Fluo	Carbon Reinforced Nylon	fi'zi:k Cycling Insole	Boa IP1-B	Microtex/Reflective Heel Cap	149 €
TPR5OCMI1-2030	Various	36-48	White/Red	Carbon Reinforced Nylon	fi'zi:k Cycling Insole	Boa IP1-B	Microtex/Reflective Heel Cap	149 €
TPR5OCMI1-1090	Various	36-48	Black/Yellow F.	Carbon Reinforced Nylon	fi'zi:k Cycling Insole	Boa IP1-B	Microtex/Reflective Heel Cap	149 €

Tempo R5 Powerstrap **NEW**

code	EAN	size	color	outsole	insole	closure	upper material	SRP
TPR5PSPU1-1010	Various	36-48	Black/Black	Carbon Reinforced Nylon	fi'zi:k Cycling Insole	Powerstrap Closure	PU upper Perforated	119 €
TPR5PSPU1-2010	Various	36-48	White/Black	Carbon Reinforced Nylon	fi'zi:k Cycling Insole	Powerstrap Closure	PU upper Perforated	119 €
TPR5PSPU1-9610	Various	36-48	Coral/Black	Carbon Reinforced Nylon	fi'zi:k Cycling Insole	Powerstrap Closure	PU upper Perforated	119 €

X-ROAD

Infinito X1



code	EAN	size	color	outsole	insole	closure	upper material	SRP
X1INFIN18-1010	Various	36-48	Black/Black	Uni Direction Full Carbon Outsole	fi'zi:k Cycling Insole	Boa IP1-B	Microtex Laser Perforated	350 €

Vento X3 Overcurve **NEW**



code	EAN	size	color	outsole	insole	closure	upper material	SRP
VEX3OCMI1-1010	Various	36-48	Black/ Black	Carbon Injected with TPU studs	fi'zi:k Cycling Insole	Single dial IP1-Boa	Microtex Laser Perforated with TPU reinforcement	219 €
VEX3OCMI1-2010	Various	36-48	White/Black	Carbon Injected with TPU studs	fi'zi:k Cycling Insole	Single dial IP1-Boa	Microtex Laser Perforated with TPU reinforcement	219 €
VEX3OCMI1-3010	Various	36-48	Red/ Black	Carbon Injected with TPU studs	fi'zi:k Cycling Insole	Single dial IP1-Boa	Microtex Laser Perforated with TPU reinforcement	219 €

Artica X5 Winter MTB Shoes With Bootie



code	EAN	size	color	outsole	insole	closure	upper material	SRP
X5ARTIC18-1010	Various	40-48	Black	Carbon Composite Ventilated / Rubber Grip	fi'zi:k Cycling Insole	Internal Speed Lacing system	Microtex Reinforced Shell	200 €

X-ROAD

Terra X5



code	EAN	size	color	outsole	insole	closure	upper material	SRP
X5TERRA18-1010	Various	36-48	Black/Black	Carbon Reinforced Nylon/ Rubber Grip	fi'zi:k Cycling Insole	Boa L6	Microtex Laser Perforated	159 €
X5TERRA18-1030	Various	36-48	Black/Red	Carbon Reinforced Nylon/ Rubber Grip	fi'zi:k Cycling Insole	Boa L6	Microtex Laser Perforated	159 €
X5TERRA18-7090	Various	36-48	Grey/Yellow Fluo	Carbon Reinforced Nylon/ Rubber Grip	fi'zi:k Cycling Insole	Boa L6	Microtex Laser Perforated	159 €

Terra X5 Suede



code	EAN	size	color	outsole	insole	closure	upper material	SRP
TEX5VCSU1-5391	Various	36-48	Suede Military Green/ Orange Fluo	Carbon Reinforced Nylon/ Rubber Grip	fi'zi:k Cycling Insole	Boa L6	Suede	175 €
NEW TEX5VCSU1-9756	Various	36-48	Dark Brown Suede/ Sage Green	Carbon Reinforced Nylon/ Rubber Grip	fi'zi:k Cycling Insole	Boa L6	Suede	175 €

M6B



code	EAN	size	color	outsole	insole	closure	upper material	SRP
M6M-BC-1010	Various	36-48	Black/Black	Carbon Reinforced Nylon/ Rubber Grip	fi'zi:k Cycling Insole	Boa L5	Microtex/Nylon Mesh/ Reflective PU	119 €

TRANSIRO

Transiro R1 Infinito Knit **NEW**



code	EAN	size	color	outsole	insole	closure	upper material	SRP
TRR1INKN1-1020	Various	36-48	Black/ White	Uni-Directional Full Carbon Ventilated Outsole	fi'zi:k Cycling Insole	Boa IP1-B	Knitted Upper	380 €

Transiro R3 Infinito **NEW**



code	EAN	size	color	outsole	insole	closure	upper material	SRP
TRR3INME1-1020	Various	36-48	Black/ White	Full carbon Outsole with Increased Ventilation	fi'zi:k Cycling Insole	Boa IP1 + Powerstrap Closure	Mesh PU Laminated Upper	249 €

Transiro R4 Powerstrap **NEW**



code	EAN	size	color	outsole	insole	closure	upper material	SRP
TRR4PSMI1-1020	Various	36-48	Black/ White	Injected composite Carbon Outsole	fi'zi:k Cycling Insole	Powerstrap Closure	Mesh upper	119 €
TRR4PSMI1-1030	Various	36-48	Black/ Red	Injected composite Carbon Outsole	fi'zi:k Cycling Insole	Powerstrap Closure	Mesh upper	119 €



Summer Racing Socks



code	EAN	size	color	description	SRP
FZSCSO 10	8058364011110	XS (36-40)	Black	Temperature control Q-Skin/Lycra Compression and Arch Support	16 €
FZSCSO 10	8058364011127	M (41-44)	Black	Temperature control Q-Skin/Lycra Compression and Arch Support	16 €
FZSCSO 10	8058364011134	XL (45-48)	Black	Temperature control Q-Skin/Lycra Compression and Arch Support	16 €
FZSCSO 20	8058364011363	XS (36-40)	White	Temperature control Q-Skin/Lycra Compression and Arch Support	16 €
FZSCSO 20	8058364011240	M (41-44)	White	Temperature control Q-Skin/Lycra Compression and Arch Support	16 €
FZSCSO 20	8058364011257	XL (45-48)	White	Temperature control Q-Skin/Lycra Compression and Arch Support	16 €
FZSCSO 1030	8058364011790	XS (36-40)	Black/Red	Temperature control Q-Skin/Lycra Compression and Arch Support	16 €
FZSCSO 1030	8058364011806	M (41-44)	Black/Red	Temperature control Q-Skin/Lycra Compression and Arch Support	16 €
FZSCSO 1030	8058364011813	XL (45-48)	Black/Red	Temperature control Q-Skin/Lycra Compression and Arch Support	16 €

Winter Racing Socks



code	EAN	size	color	description	SRP
FZWCSO 10	8058364011110	XS (36-40)	Black	Temperature control Q-Skin/Lycra Compression and Arch Support	20 €
FZWCSO 10	8058364011127	M (41-44)	Black	Temperature control Q-Skin/Lycra Compression and Arch Support	20 €
FZWCSO 10	8058364011134	XL (45-48)	Black	Temperature control Q-Skin/Lycra Compression and Arch Support	20 €
FZWCSO 20	8058364011363	XS (36-40)	White	Temperature control Q-Skin/Lycra Compression and Arch Support	20 €
FZWCSO 20	8058364011240	M (41-44)	White	Temperature control Q-Skin/Lycra Compression and Arch Support	20 €
FZWCSO 20	8058364011257	XL (45-48)	White	Temperature control Q-Skin/Lycra Compression and Arch Support	20 €
FZWCSO 1030	8058364011851	XS (36-40)	Black/Red	Temperature control Q-Skin/Lycra Compression and Arch Support	20 €
FZWCSO 1030	8058364011882	M (41-44)	Black/Red	Temperature control Q-Skin/Lycra Compression and Arch Support	20 €
FZWCSO 1030	8058364011097	XL (45-48)	Black/Red	Temperature control Q-Skin/Lycra Compression and Arch Support	20 €

Windproof Toe Cover



code	EAN	size	color	description	SRP
FZTCW 10	8058364011899	XS (36-40)	Black	PU Cloth Main Fabric/Microfiber Toe Cap & Puller/Bottom PU Reinforced	25 €
FZTCW 10	8058364011325	M (41-44)	Black	PU Cloth Main Fabric/Microfiber Toe Cap & Puller/Bottom PU Reinforced	25 €
FZTCW 10	8058364011349	XL /45-48)	Black	PU Cloth Main Fabric/Microfiber Toe Cap & Puller/Bottom PU Reinforced	25 €

Waterproof Winter Overshoe



code	EAN	size	color	material	SRP
FZSCWP 1094	8058364011271	S (36-39)	Black Reflective	WP and Windproof Upper, Rubberized Bottom for Better Grip, Reflec. logo and Piping	59 €
FZSCWP 1094	8058364011288	M (40-43)	Black Reflective	WP and Windproof Upper, Rubberized Bottom for Better Grip, Reflec. logo and Piping	59 €
FZSCWP 1094	8058364011295	L (44-46)	Black Reflective	WP and Windproof Upper, Rubberized Bottom for Better Grip, Reflec. logo and Piping	59 €
FZSCWP 1094	8058364011301	XL (47-48)	Black Reflective	WP and Windproof Upper, Rubberized Bottom for Better Grip, Reflec. logo and Piping	59 €

Shoes Spare Parts

CODE	SIZE	COLOR	DESCRIPTION	SRP
FZHSPR1-C 10	S (39-44,5)	Black	Heel Skid Plate (pair) R1B shoes	13 €
FZHSPR1-C 10	L (45-48)	Black	Heel Skid Plate (pair) R1B shoes	13 €
FZHSPR3-C 10	S (36-40,5)	Black	Heel Skid Plate (pair) R3B shoes	13 €
FZHSPR3-C 10	M (41-44,5)	Black	Heel Skid Plate (pair) R3B shoes	13 €
FZHSPR3-C 10	L (45-48)	Black	Heel Skid Plate (pair) R3B shoes	13 €

Spare Parts/Kit BOA Shoes

CODE	COMPATIBILITY	COLOR	SRP
1000196 - 20	BOA R1 / right+left	White/Transparent	25 €
B1728 - 10	BOA R1 / right+left	Black	25 €
B1601 - 1012	BOA M3 - M5 / only left	Anthracite	16 €
B1602 - 1012	BOA M3 - M5 / only right	Anthracite	16 €
B1729 - 10	BOA M6 / right+left	Black	19 €
B1850 - 10	BOA M4 - TERRA X5 / right+left	Black	19 €



LINK THE BIB SHORTS INTERFACE FOR EVERY TYPE OF RIDER

**SELLA E PANTALONCINO SVILUPPATI ASSIEME
PER LA PRIMA VOLTA.**

LINK è disponibile in tre differenti taglie e tre differenti fondelli identificabili secondo lo Spine Concept EVO.
Ogni atleta si può identificare con il suo archetipo di ciclista: Snake, Bull e Chameleon.

**POUR LA PREMIÈRE FOIS SELLES ET CUISSARDS
SONT CONÇUS ENSEMBLE.**

LINK est disponible en trois coupes et peaux différentes pour correspondre à chaque de cycliste suivant les critères
Spine Concept EVO fi'zi:k et adapté au type de coureur Snake, Bull ou Chameleon.



Link R1
Made for Snake

sizes available: S/M/L/XL/XXL



code	EAN	color	fit	materials	chamois	leg gripper	weight	SRP
LINKSNR1-10	various	Black/Red	Racing	Lightweight woven fabrics	Lightweight/Breathable 3D moulded seamless	Welded grip stripe/Seamless	155 g	275 €



Link R3
Made for Snake

sizes available: S/M/L/XL/XXL



code	EAN	color	fit	materials	chamois	leg gripper	weight	SRP
LINKSNR3-10	Various	Black/Grey	Performance	Specifically developed polyamide and elasthan non-woven fabrics	lightweight/breathable high performance chamois	silicon printed elastic	189 g	180 €



Link R1
Made for Chameleon

sizes available: S/M/L/XL/XXL



code	EAN	color	fit	materials	chamois	leg gripper	weight	SRP
LINKCHR1-10	Various	Black/Red	Racing	Lightweight woven fabrics	Lightweight/Breathable 3D moulded seamless	Welded grip stripe/Seamless	155 g	275 €



Link R3
Made for Chameleon

sizes available: S/M/L/XL/XXL



code	EAN	color	fit	materials	chamois	leg gripper	weight	SRP
LINKCHR3-10	Various	Black/Grey	Performance	Specifically developed polyamide and elasthan non-woven fabrics	lightweight/breathable high performance chamois	silicon printed elastic	189 g	180 €



Link R1
Made for Bull

sizes available: S/M/L/XL/XXL



code	EAN	color	fit	materials	chamois	leg gripper	weight	SRP
LINKBLR1-10	Various	Black/Red	Racing	Lightweight woven fabrics	Lightweight/Breathable 3D moulded seamless	Welded grip stripe/Seamless	155 g	275 €



Link R3
Made for Bull

sizes available: S/M/L/XL/XXL



code	EAN	color	fit	materials	chamois	leg gripper	weight	SRP
LINKBLR3-10	Various	Black/Grey	Performance	Specifically developed polyamide and elasthan non-woven fabrics	lightweight/breathable high performance chamois	silicon printed elastic	189 g	180 €



COMPONENTS

COMPONENTS



Cyrano handlebar 00
Made for Snake

Body Material: Highmodulus Uni-Directional Carbon
Finishing: Matt Black/Yellow 00 details



code	EAN	diameter	size (mm)	reach	drop	weight	SRP
114012R	8021890387394	31,8 (clamp) -24,8 (top)	400 center to center	80 mm	130 mm		350 €
114013R	8021890387400	31,8 (clamp) -28,8 (top)	420 center to center	85 mm	140 mm	175 g	350 €
114014R	8021890387417	31,8 (clamp) -28,8 (top)	440 center to center	85 mm	140 mm		350 €
114015R	8021890387424	31,8 (clamp) -28,8 (top)	460 center to center	85 mm	140 mm		350 €



Cyrano handlebar 00
Made for Chameleon

Body Material: Highmodulus Uni-Directional Carbon
Finishing: Matt Black/Yellow 00 details



code	EAN	diameter	size (mm)	reach	drop	weight	SRP
114007R	8021890387349	31,8 (clamp) -24,8 (top)	400 center to center	80 mm	130 mm		350 €
114008R	8021890387356	31,8 (clamp) -28,8 (top)	420 center to center	85 mm	135 mm	175 g	350 €
114009R	8021890387363	31,8 (clamp) -28,8 (top)	440 center to center	85 mm	135 mm		350 €
114010R	8021890387370	31,8 (clamp) -28,8 (top)	460 center to center	85 mm	135 mm		350 €



Cyrano handlebar 00
Made for Bull

Body Material: Highmodulus Uni-Directional Carbon
Finishing: Matt Black/Yellow 00 details



code	EAN	diameter	size (mm)	reach	drop	weight	SRP
114002R	8021890387295	31,8 (clamp) -24,8 (top)	400 center to center	75 mm	125 mm		350 €
114003R	8021890387301	31,8 (clamp) -28,8 (top)	420 center to center	80 mm	130 mm	175 g	350 €
114004R	8021890387318	31,8 (clamp) -28,8 (top)	440 center to center	80 mm	130 mm		350 €
114005R	8021890387325	31,8 (clamp) -28,8 (top)	460 center to center	80 mm	130 mm		350 €

COMPONENTS



Cyrano handlebar R1
Made for Snake

Body Material: Uni-Directional Carbon
Finishing: Glossy Carbon/Red R1 details



code	EAN	diameter	size (mm)	reach	drop	weight	SRP
114027R	8021890387547	31,8 (clamp) -24,8 (top)	400 center to center	80 mm	130 mm		250 €
114028R	8021890387554	31,8 (clamp) -28,8 (top)	420 center to center	85 mm	140 mm	205 g	250 €
114029R	8021890387561	31,8 (clamp) -28,8 (top)	440 center to center	85 mm	140 mm		250 €
114030R	8021890387578	31,8 (clamp) -28,8 (top)	460 center to center	85 mm	140 mm		250 €



Cyrano handlebar R1
Made for Chameleon

Body Material: Uni-Directional Carbon
Finishing: Glossy Carbon/Red R1 details



code	EAN	diameter	size (mm)	reach	drop	weight	SRP
114022R	8021890387493	31,8 (clamp) -24,8 (top)	400 center to center	80 mm	130 mm		250 €
114023R	8021890387509	31,8 (clamp) -28,8 (top)	420 center to center	85 mm	135 mm	205 g	250 €
114024R	8021890387516	31,8 (clamp) -28,8 (top)	440 center to center	85 mm	135 mm		250 €
114025R	8021890387523	31,8 (clamp) -28,8 (top)	460 center to center	85 mm	135 mm		250 €



Cyrano handlebar R1
Made for Bull

Body Material: Uni-Directional Carbon
Finishing: Glossy Carbon/Red R1 details



code	EAN	diameter	size (mm)	reach	drop	weight	SRP
114017R	8021890387448	31,8 (clamp) -24,8 (top)	400 center to center	75 mm	125 mm		250 €
114018R	8021890387455	31,8 (clamp) -28,8 (top)	420 center to center	80 mm	130 mm	205 g	250 €
114019R	8021890387462	31,8 (clamp) -28,8 (top)	440 center to center	80 mm	130 mm		250 €
114020R	8021890387479	31,8 (clamp) -28,8 (top)	460 center to center	80 mm	130 mm		250 €

COMPONENTS



Cyrano handlebar R3
Made for Snake

Body Material: Aluminum Ergal
Finishing: Matt Sandblasted Black/White R3 details



code	EAN	diameter	size (mm)	reach	drop	weight	SRP
114041R	8021890387684	31,8 (clamp) -24,8 (top)	380 center to center	75 mm	125 mm		99 €
114042R	8021890387691	31,8 (clamp) -24,8 (top)	400 center to center	80 mm	130 mm	245 g	99 €
114043R	8021890387707	31,8 (clamp) -28,8 (top)	420 center to center	85 mm	140 mm		99 €
114044R	8021890387714	31,8 (clamp) -28,8 (top)	440 center to center	85 mm	140 mm		99 €
114045R	8021890387721	31,8 (clamp) -28,8 (top)	460 center to center	85 mm	140 mm		99 €



Cyrano handlebar R3
Made for Chameleon

Body Material: Aluminum Ergal
Finishing: Matt Sandblasted Black/White R3 details



code	EAN	diameter	size (mm)	reach	drop	weight	SRP
114036R	8021890367639	31,8 (clamp) -24,8 (top)	380 center to center	80 mm	130 mm		99 €
114037R	8021890387646	31,8 (clamp) -24,8 (top)	400 center to center	80 mm	130 mm	245 g	99 €
114038R	8021890387653	31,8 (clamp) -28,8 (top)	420 center to center	85 mm	135 mm		99 €
114039R	8021890387660	31,8 (clamp) -28,8 (top)	440 center to center	85 mm	135 mm		99 €
114040R	8021890387677	31,8 (clamp) -28,8 (top)	460 center to center	85 mm	135 mm		99 €



Cyrano handlebar R3
Made for Bull

Body Material: Aluminum Ergal
Finishing: Matt Sandblasted Black/White R3 details



code	EAN	diameter	size (mm)	reach	drop	weight	SRP
114031R	8021890387585	31,8 (clamp) -24,8 (top)	380 center to center	75 mm	125 mm		99 €
114032R	8021890387592	31,8 (clamp) -24,8 (top)	400 center to center	75 mm	125 mm	245 g	99 €
114033R	8021890387608	31,8 (clamp) -28,8 (top)	420 center to center	80 mm	130 mm		99 €
114034R	8021890387615	31,8 (clamp) -28,8 (top)	440 center to center	80 mm	130 mm		99 €
114035R	8021890387622	31,8 (clamp) -28,8 (top)	460 center to center	80 mm	130 mm		99 €

COMPONENTS



Cyrano handlebar R5
Made for Snake

Body Material: Aluminum Anticordal
Finishing: Matt Sandblasted Black R5 details



code	EAN	diameter	size (mm)	reach	drop	weight	SRP
114057R	8021890439185	31,8 (clamp) -24,8 (top)	400 center to center	80 mm	130 mm		49 €
114058R	8021890439192	31,8 (clamp) -28,8 (top)	420 center to center	85 mm	140 mm	310 g	49 €
114059R	8021890439208	31,8 (clamp) -28,8 (top)	440 center to center	85 mm	140 mm		49 €



Cyrano handlebar R5
Made for Chameleon

Body Material: Aluminum Anticordal
Finishing: Matt Sandblasted Black R5 details



code	EAN	diameter	size (mm)	reach	drop	weight	SRP
114052R	8021890439154	31,8 (clamp) -24,8 (top)	400 center to center	80 mm	130 mm		49 €
114053R	8021890439161	31,8 (clamp) -28,8 (top)	420 center to center	85 mm	135 mm	310 g	49 €
114054R	8021890439178	31,8 (clamp) -28,8 (top)	440 center to center	85 mm	135 mm		49 €



Cyrano handlebar R5
Made for Bull

Body Material: Aluminum Anticordal
Finishing: Matt Sandblasted Black R5 details



code	EAN	diameter	size (mm)	reach	drop	weight	SRP
114047R	8021890439123	31,8 (clamp) -24,8 (top)	400 center to center	75 mm	125 mm		49 €
114048R	8021890439130	31,8 (clamp) -28,8 (top)	420 center to center	80 mm	130 mm	310 g	49 €
114049R	8021890439147	31,8 (clamp) -28,8 (top)	440 center to center	80 mm	130 mm		49 €



Cyrano 00 Seatpost

Body Material: Highmodulus Uni-Directional Carbon
 Head Material: Aluminum-Ergal
 Bolts: Titanium
 Finishing: Matt Black/Yellow 00 details

code	EAN	diameter	size	seatback	weight	SRP
114177R	8021890411570	Cyrano Carbon Seatpost 27,2	330 mm	25 mm	175 g	250 €
114178R	8021890411594	Cyrano Carbon Seatpost 31,6	330 mm	25 mm	195 g	250 €

Cyrano R3 Seatpost

Body Material: Aluminum-Ergal
 Head Material: Aluminum-Ergal
 Bolts: Stainless steel
 Finishing: Matt Sandblasted Black/Red R3 details

code	EAN	diameter	size	seatback	weight	SRP
114119R	8021890388995	27,2	330 mm	25 mm		99 €
114120R	8021890389008	27,2	400 mm	26 mm	215 g	99 €
114125R	8021890389039	31,6	330 mm	27 mm		99 €
114126R	8021890389046	31,6	400 mm	28 mm		99 €

Cyrano R5 Seatpost

Body Material: Aluminum-Ergal
 Head Material: Aluminum-Ergal
 Bolts: Stainless steel

code	EAN	diameter	size	seatback	weight	SRP
114131R	8021890439284	27,2	330 mm	25 mm		49 €
114132R	8021890439291	27,2	400 mm	26 mm	215 g	49 €
114137R	8021890439307	31,6	330 mm	27 mm		49 €
114138R	8021890439314	31,6	400 mm	28 mm		49 €



Cyrano R1 stem

Body Material: Aluminum-Ergal
 Head Material: Aluminum-Anticorodal
 Bolts: Titanium
 Finishing: Matt Sandblasted Black/Red R1 details

code	EAN	diameter	size	angle	weight	SRP
114062R	8021890 387745	31,8 mm	70 mm	7 °		99 €
114063R	8021890387752	31,8 mm	80 mm	7 °	128 g	99 €
114064R	8021890387769	31,8 mm	90 mm	7 °		99 €
114065R	8021890387776	31,8 mm	100 mm	7 °		99 €
114066R	8021890387783	31,8 mm	110 mm	7 °		99 €
114067R	8021890387790	31,8 mm	120 mm	7 °		99 €
114068R	8021890387806	31,8 mm	130 mm	7 °		99 €
114072R	8021890387844	31,8 mm	80 mm	20 °		99 €
114073R	8021890387851	31,8 mm	90 mm	20 °		99 €
114074R	8021890387868	31,8 mm	100 mm	20 °		99 €
114075R	8021890387875	31,8 mm	110 mm	20 °		99 €
114076R	8021890387882	31,8 mm	120 mm	20 °		99 €
114077R	8021890387899	31,8 mm	130 mm	20 °		99 €

Cyrano R5 stem

Body Material: Aluminum-Anticorodal
 Head Material: Aluminum-Anticorodal
 Bolts: Stainless Steel

code	EAN	diameter	size	angle	weight	SRP
114099R	8021890439222	31,8 mm	80 mm	7 °		49 €
114100R	8021890439239	31,8 mm	90 mm	7 °	152 g	49 €
114101R	8021890439246	31,8 mm	100 mm	7 °		49 €
114102R	8021890439253	31,8 mm	110 mm	7 °		49 €
114103R	8021890439260	31,8 mm	120 mm	7 °		49 €
114104R	8021890439277	31,8 mm	130 mm	7 °		49 €



Stem Bolt replacing kit



Seatpost 00 Bolt replacing kit



Seatpost R1/R3 Bolt replacing kit



code	EAN	description	bolts	vis	SRP
114184R	8021890 423894	Stem bolt replacing kit	Titanium	Titanium	35 €
114192R	8021890 432049	Seatpost 00 bolt replacing kit	Titanium	Titanium	30 €
114191R	8021890 432032	Seatpost R1/R3 bolt replacing kit	Stainless steel	Acier inoxydable	20 €



ACCESSORIES

Vento Microtex Tacky



code	EAN	color	construction	touch	thickness	SRP
BT09 A00042	8021890466457	Black	Microtex	Tacky	2,0 mm	34,90 €
BT09 A00044	8021890466464	White	Microtex	Tacky	2,0 mm	34,90 €
BT09 A00012	8021890466440	Red	Microtex	Tacky	2,0 mm	34,90 €
BT09 A00047	8021890466488	Orange Fluo	Microtex	Tacky	2,0 mm	34,90 €
BT09 A00050	8021890466495	Pink Fluo	Microtex	Tacky	2,0 mm	34,90 €
BT09 A00046	8021890466471	Yellow Fluo	Microtex	Tacky	2,0 mm	34,90 €
BT09 A00051	8021890466501	Lilla Fluo	Microtex	Tacky	2,0 mm	34,90 €
BT09 A00009	8021890466433	Celeste	Microtex	Tacky	2,0 mm	34,90 €

Vento Solocush Tacky



code	EAN	color	construction	touch	thickness	SRP
BT11 A00042	8021890466686	Black	Solocush	Tacky	2,7 mm	37,90 €
BT11 A00044	8021890466693	White	Solocush	Tacky	2,7 mm	37,90 €
BT11 A00055	8021890467034	Blue	Solocush	Tacky	2,7 mm	37,90 €
BT11 A00025	8021890466679	Green	Solocush	Tacky	2,7 mm	37,90 €
BT11 A00012	8021890466655	Red	Solocush	Tacky	2,7 mm	37,90 €
BT11 A00011	8021890466648	Pink	Solocush	Tacky	2,7 mm	37,90 €
BT11 A00014	8021890466662	Yellow	Solocush	Tacky	2,7 mm	37,90 €
BT11 A00047	8021890466716	Orange Fluo	Solocush	Tacky	2,7 mm	37,90 €
BT11 A00050	8021890466723	Pink Fluo	Solocush	Tacky	2,7 mm	37,90 €
BT11 A00046	8021890466709	Yellow Fluo	Solocush	Tacky	2,7 mm	37,90 €
BT11 A00051	8021890466730	Lilla Fluo	Solocush	Tacky	2,7 mm	37,90 €
BT11 A00009	8021890466631	Celeste	Solocush	Tacky	2,7 mm	37,90 €

Terra Microtex Bondcush Tacky



code	EAN	color	construction	touch	thickness	SRP
BT12 A00002	8021890466747	Black	Microtex Bondcush	Tacky	3,0 mm	37,90 €
BT12 A00016	8021890466761	White	Microtex Bondcush	Tacky	3,0 mm	37,90 €
BT12 A00012	8021890466754	Red	Microtex Bondcush	Tacky	3,0 mm	37,90 €
BT12 A00052	8021890466778	Dark Blue	Microtex Bondcush	Tacky	3,0 mm	37,90 €
BT12 A00053	8021890466785	Green/Blue	Microtex Bondcush	Tacky	3,0 mm	37,90 €
BT12 A00054	8021890466792	Brown	Microtex Bondcush	Tacky	3,0 mm	37,90 €

Tempo Microtex Classic



code	EAN	color	construction	touch	thickness	SRP
BT10 A00032	8021890466600	Black	Microtex	Classic	2,0 mm	19,90 €
BT10 A00010	8021890466549	White	Microtex	Classic	2,0 mm	19,90 €
BT10 A00055	8021890467027	Blue	Microtex	Classic	2,0 mm	19,90 €
BT10 A00025	8021890466594	Green	Microtex	Classic	2,0 mm	19,90 €
BT10 A00012	8021890466563	Red	Microtex	Classic	2,0 mm	19,90 €
BT10 A00011	8021890466556	Pink	Microtex	Classic	2,0 mm	19,90 €
BT10 A00014	8021890466570	Yellow	Microtex	Classic	2,0 mm	19,90 €
BT10 A00045	8021890466617	Orange	Microtex	Classic	2,0 mm	19,90 €
BT10 A00018	8021890466587	Honey	Microtex	Classic	2,0 mm	19,90 €
BT10 A00006	8021890466525	Silver	Microtex	Classic	2,0 mm	19,90 €
BT10 A00009	8021890466532	Celeste	Microtex	Classic	2,0 mm	19,90 €

Tempo Microtex Bondcush Classic



code	EAN	color	construction	touch	thickness	SRP
BT13 A00032	8021890466891	Black	Microtex Bondcush	Classic	3,0 mm	24,90 €
BT13 A00010	8021890466839	White	Microtex Bondcush	Classic	3,0 mm	24,90 €
BT13 A00055	8021890467041	Blue	Microtex Bondcush	Classic	3,0 mm	24,90 €
BT13 A00025	8021890466884	Green	Microtex Bondcush	Classic	3,0 mm	24,90 €
BT13 A00012	8021890466853	Red	Microtex Bondcush	Classic	3,0 mm	24,90 €
BT13 A00011	8021890466846	Pink	Microtex Bondcush	Classic	3,0 mm	24,90 €
BT13 A00014	8021890466860	Yellow	Microtex Bondcush	Classic	3,0 mm	24,90 €
BT13 A00045	8021890466907	Orange	Microtex Bondcush	Classic	3,0 mm	24,90 €
BT13 A00018	8021890466877	Honey	Microtex Bondcush	Classic	3,0 mm	24,90 €
BT13 A00006	8021890466815	Silver	Microtex Bondcush	Classic	3,0 mm	24,90 €
BT13 A00009	8021890466822	Celeste	Microtex Bondcush	Classic	3,0 mm	24,90 €

Tempo Microtex Bondcush Soft



code	EAN	color	construction	touch	thickness	SRP
BT14 A00002	8021890466914	Black	Microtex Bondcush	Soft	3,0 mm	24,90 €
BT14 A00025	8021890467003	Green	Microtex Bondcush	Soft	3,0 mm	24,90 €
BT14 A00012	8021890466969	Red	Microtex Bondcush	Soft	3,0 mm	24,90 €
BT14 A00014	8021890466976	Yellow	Microtex Bondcush	Soft	3,0 mm	24,90 €
BT14 A00045	8021890467010	Orange	Microtex Bondcush	Soft	3,0 mm	24,90 €

ACCESSORIES

Kli:k Bag



code	EAN	size	color	description	SRP
FB05S00A0X004	8021890427298	S	Anthracite	Cordura Shell / WP Zip, Internal Pocket / Reflective Piping	19,90 €
FB05M00A0X004	8021890427403	M	Anthracite	Reflective logo / ICS clip	24,90 €

Lin:k Bag



code	EAN	size	color	description	SRP
FB06S00A0X004	8021890427311	S	Anthracite	Cordura Shell / WP Zip Internal Pocket / Reflective Piping	17,90 €
FB06M00A0X004	8021890427304	M	Anthracite	Reflective logo / Velcro straps	22,90 €

00 Saddle Bag



code	EAN	size	color	description	SRP
FB0700 A031111	8021890428486	One Size	Black	Thermo-Formed Classic and Gummy Microtex / TPR Closure System Padded Inside / 00 Details	40 €

Lumo L1 / Lumo L5



code	EAN	color	description	SRP
BLF3 A00000	8021890427199	Black	LUMO L1: 4 red modes / white courtesy light USB rechargeable / ICS and seatpost compatible	35 €
BLF4 A00000	8021890427205	Black	LUMO L5: 4 red modes / USB rechargeable ICS and seatpost compatible	24,90 €



SeatPost Rings



code	EAN	color	material	SRP
FZKR A30003	8021890363978	White, Black, Yellow, Red, Green, Seed Blue, Dark Blue	Kit of 42 Silicon Rings, mixed colours and sizes	6 € cad.
FZKR A7S007	8021890393036	White	Silicon Ring 27,2 mm	6 €
FZKR A8S009	8021890393043	Black	Silicon Ring 27,2 mm	6 €
FZKR A9S003	8021890393050	Red	Silicon Ring 27,2 mm	6 €
FZKR B0S007	8021890393067	White	Silicon Ring 30,9 - 31 mm	6 €
FZKR B1S009	8021890393074	Black	Silicon Ring 30,9 - 31 mm	6 €
FZKR B2S003	8021890393081	Red	Silicon Ring 30,9 - 31 mm	6 €

Kit Bar:Gel + Tape



Bar:Gel



Performance Road Bar:Gel

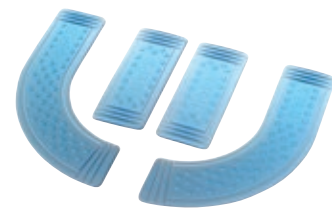

code	EAN	description	SRP
BG01 A00002	8021890225108	Black Microtex Bar Tape + Bar Gel	33,90 €
BG02 A00003	8021890235756	4 Pieces of Gel (2 curved + 2 straight)	20 €
BG06 A00000	8021890367518	4 Pieces of Medical TechnoGel (2 curved + 2 straight)	24,90 €

Tri Gel:Pad



code	EAN	description	SRP
BG04 A03900	8021890264565	Technogel Pad Designed for Profile F19/F22 Armrest	35 €
BG05 A03900	8021890264589	Technogel Pad Designed for Vision Armrest	35 €

Aliante Scuff Guards Kit



code	EAN	description	SRP
FZKS H00000	8021890425607	3 sets of scuff guards and 12 spare bolts / White, Black, Red	19,90 €
FZKS H10000	8021890425614	3 sets of scuff guards and 12 spare bolts / Green, Anthracite, Blue	19,90 €

Transiro Mistica Carriage Kit



code	EAN	description	SRP
FZKS J20000	8021890431769	Integral aluminum carriage kit, with 4 bolts	30 €

Spine Concept Versus Evo Saddle Display



code	FZKS L00000
EAN	8021890457233
dimension	180x50x50 cm
description	New Spine Concept Versus Evo Display + 12 Versus Evo Saddles

Spine Concept Evo Open 2018 Saddle Display



code	FZKS L10000
EAN	8021890457240
dimension	170x70x15 cm
description	New Spine Concept Open Display + 12 Open Saddles

Spine Concept Evo Full Update Kit

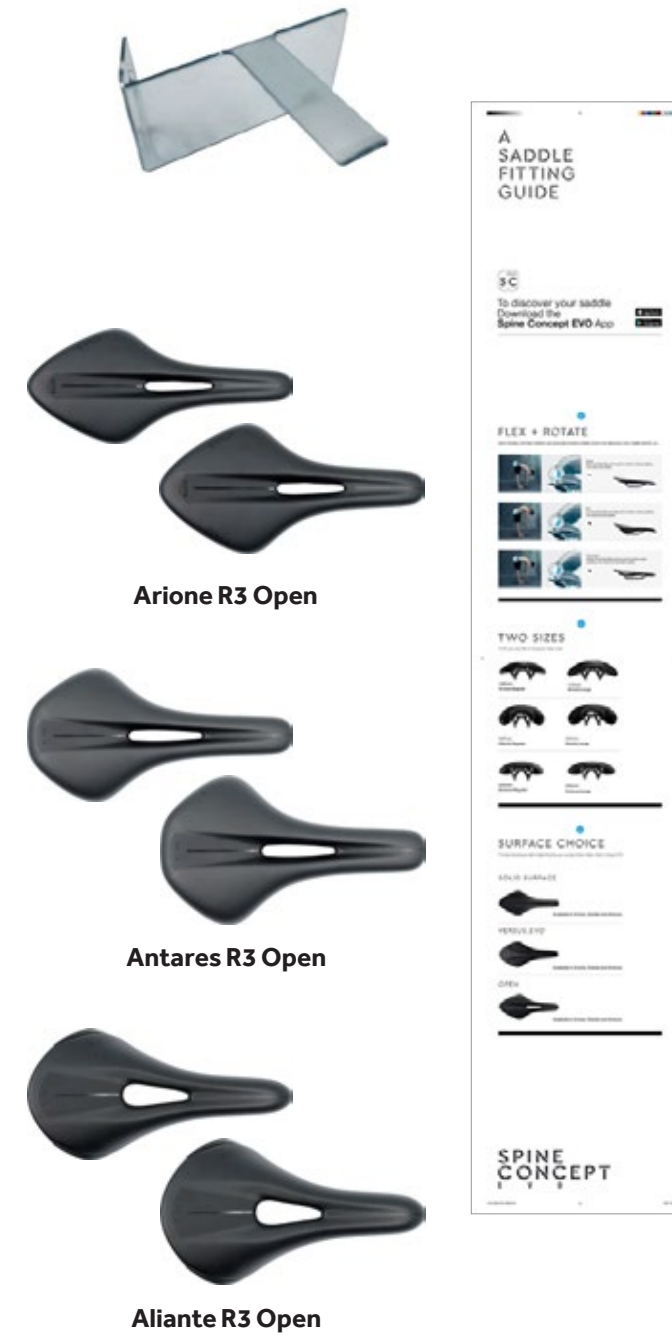

code	FZKS L50000
EAN	8021890460196
dimension	-
description	New Board + New Hooks + 6 R3 Open Saddles (3 Regular + 3 Large)

Shoes Shelf NEW



code	FZME 10
EAN	8058364043326
dimension	w 280 / h 65 / d 110 mm
description	Shelf Shoes Black
SRP	6 €

New Open Test Kit

code	EAN	description
FZKS L30000	8021890459701	6 R3 Open Test Saddles (3 Regular + 3 Large)

New Versus Evo Test Kit

code	EAN	description
FZKS L40000	8021890459718	6 R3 Versus Evo Test Saddles (3 Regular + 3 Large)

Solid Surface Test Kit

code	EAN	description
FZKS K20000	8021890448187	3 R3 Solid Test Saddles Regular (Arione, Antares, Aliante)
FZKS K30000	8021890448194	3 R3 Solid Test Saddles Large (Arione, Antares, Aliante)

Transiro Mistica Test Kit

code	EAN	description
FZKS K50000	8021890448682	TRANSIRO MISTICA TEST KIT: 1 Mistica k:iium Regular Test+ 1 Mistica k:iium Large Test
FZKS K70000	8021890448705	LUCE TEST KIT: 1 Luce R5 Regular Test + 1 Luce R5 Large Test

Luce Test Kit

**Bar tape Selector
+ 48 Bar tapes**



code	FZKW B10000
EAN	8021890468697
dimension	w 260 / h 400 / d 300 mm
description	2 Wheels Bar tape Display + 48 fi'zi:k Bar tapes

Vento Microtex Tacky / 2,0 mm



Vento Solocush Tacky / 2,7 mm



Terra Microtex Bondcush Tacky / 3,0 mm



Tempo Microtex Classic / 2,0 mm



Tempo Microtex Bondcush Classic / 3,0 mm



Tempo Microtex Bondcush Soft / 3,0 mm







CIÒ CHE SAPPIAMO FARE | NOTRE SAVOIR FAIRE

Cerchiamo l'avventura e la libertà che questa sa darti. Ci piace la solitudine profonda della montagna e ci divertiamo a far festa tutti assieme con una birra nel dopo corsa. Il gusto della competizione ci ha forgiato e conosciamo il gusto dolce della vittoria.

L'aventure et la liberté sont notre moteur. Nous adorons la solitude de la montagne et après la compétition, nous retrouver autour d'une bière pour savourer la douceur de la victoire.

**PROGETTIAMO COMPONENTI PER MOUNTAIN BIKE CHE ASSICURANO PRESTAZIONI SUPERIORI ATTRAVERSO UN DESIGN CHE ROMPE GLI SCHEMI.
NOUS CONCEVONS DES COMPOSANTS POUR VTT DE QUALITÉ ET DE FONCTIONS SUPÉRIEURES, D'UN DESIGN HORS DU COMMUN.**

 crankbrothers

UNA RIVOLUZIONE IN TERMINI DI PERFORMANCE ED AFFIDABILITÀ

Nuovi modelli, tecnologie avanzate e componenti d'alta gamma si combinano nella nostra linea di pedali, la più innovativa di sempre.

UNE RÉVOLUTION EN TERMES DE PERFORMANCE ET FIABILITÉ

De nouveaux modèles, des technologies innovantes et des composants haut de gamme caractérisent notre ligne de pédales, le tout dans un niveau de finition jamais atteint.



COMPONENTI DI QUALITÀ SUPERIORE | COMPOSANTS DE QUALITÉ PREMIUM

AFFIDABILITÀ, RESISTENZA E PERFORMANCE | DURABLE RESISTANT ET PERFORMANT

CUSCINETTI ENDURO | ROULEMENT ENDURO

SISTEMA DI CUSCINETTI ESTERNI PREMIUM

- Progettati in modo specifico per pedali (bassa velocità, alto valore di coppia)
- Materiali, lubrificante e guarnizioni di qualità premium
- Maggior resistenza alla corrosione
- Tolleranze maggiori per un fit più preciso

ROULEMENT EXTERNE PREMIUM

- Conçu spécifiquement pour les pédales (basse vitesse, couple élevé)
- Matériaux, roulements et graisse de qualité supérieure
- Résistance à la corrosion
- Tolérances supérieures pour un ajustement précis



CUSCINETTI IGUS LL-GLIDE | ROULEMENT IGUS LL-GLIDE

SISTEMA DI CUSCINETTI INTERNO PREMIUM

- Sviluppati in esclusiva per Crankbrothers
- Una performance otto volte superiore dai test in laboratorio di igus
- Una performance fino a 74 volte migliore dai test condotti da Crankbrothers
- Ottime prestazioni anche in condizioni avverse

ROULEMENT INTERNE PREMIUM

- Développés en exclusivité pour Crankbrothers
- Une performance 8 fois supérieure selon les tests de laboratoire aigus
- Une performance 74 fois supérieure selon nos derniers tests en interne.
- Effectué dans les conditions les plus extrêmes



SISTEMA A DOPPIA GUARNIZIONE | DOUBLE SYSTÈME D'ÉTANCHÉITÉ

GUARNIZIONE INTERNA DOUBLE-LIP E GUARNIZIONE ESTERNA

- Impedisce l'entrata di sporco e acqua all'interno del pedale
- Test di laboratorio e su strada condotti in condizioni estreme
- Previene dalla corrosione dei pedali e ne aumenta la durata nel tempo

JOINT INTERNE DOUBLE-LIP ET JOINT EXTÉRIEUR

- Empêche l'eau et la boue de pénétrer à l'intérieur de la pédale
- Testé en laboratoire et sur le terrain dans les pires conditions
- Protège de la corrosion et prolonge la vie de la pédale



guarnizione interna double-lip
joint interne double-lip

guarnizione esterna
joint extérieur

APPROCCIO 3D: LARGHEZZA E LUNGHEZZA | APPROCHE 3D: LONGUEUR ET LARGEUR

AREA DI CONTATTO OTTIMIZZATA | SURFACE DE CONTACT OPTIMALE

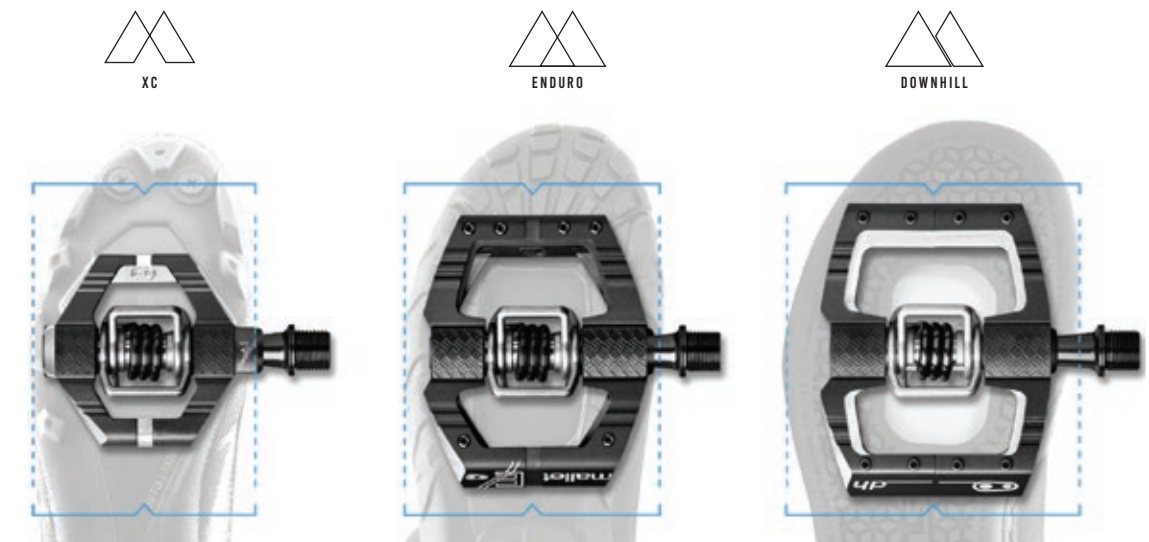

CANDY 7

90-105 mm SHOE WIDTH

MALLET E

105-110 mm SHOE WIDTH

MALLET DH

100+mm SHOE WIDTH

- Basata sullo studio delle soles delle scarpe
- Interfaccia scarpa/pedale ottimizzata per tutte le discipline
- Trazione e grip migliorato
- Perno più lungo su alcuni modelli

- Basé sur nos recherche par rapport aux dimensions des semelles des chaussures
- Dimension des pédales adaptée à toutes pratiques
- Accroche et maintien sur la pédale optimisés
- Certains modèles dotés de "pins" plus longs

APPROCCIO 3D: PROFONDITÀ DEL BATTISTRADA | APPROCHE 3D STRIES PROFONDES

INTERFACCIA TRA PEDALE E SCARPA OTTIMIZZATA | INTERFACE OPTIMISEE ENTRE LA PEDALE ET LA CHAUSSURE

TECNOLOGIA TRACTION PAD | TECHNOLOGIE TRACTION PAD

- Direttamente integrata nei modelli Mallet E 11, Mallet E LS, Mallet E, Mallet DH, Mallet DH 11, Candy 11 e Candy 7
- Insetto in poliuretano con area di contatto diamantata per aumentare il controllo
- Spessori intercambiabili 1 e 2 mm inclusi nei pedali
- Ingaggio ottimale della tacchetta
- Area di contatto ottimizzata tra suola, scarpa e pedale
- Personalizzabile per avere l'interfaccia perfetta con qualunque scarpa

- Directement intégré dans les modèles de pédales Mallet E 11, Mallet E LS, Mallet E, Mallet DH, Mallet DH 11, Candy 11 et Candy 7
- Pad polyuréthane avec motif diamant
- Pad interchangeables de 1 et 2 mm inclus avec les pédales
- Optimise l'engagement des cales
- Optimise le contact de la chaussure avec le corps de la pédale
- Personnalisable pour obtenir l'interface parfaite avec tout type de chaussures

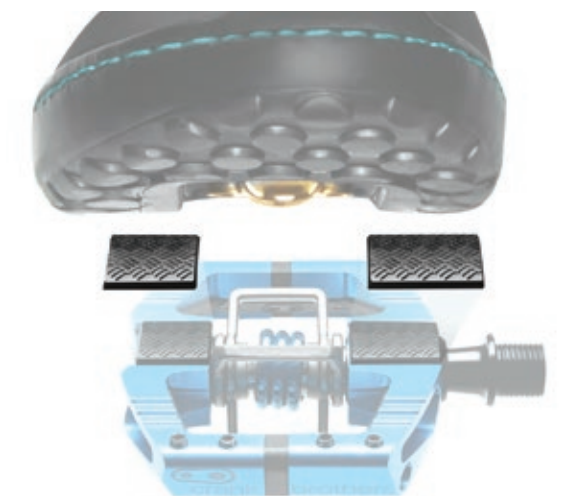

THE MALLET COLLECTION



MALLET DH 11



black/gold

code	16096
weight	445 g
price	€ 350

MALLET DH RACE



red

black

red/blue/black

code	16095	16094	16248
weight	479 g	479 g	479 g
price	€ 169	€ 169	€ 169

// LIMITED EDITION

SUPER BRUNI MALLET DH 11
// LIMITED EDITION



THE MALLET COLLECTION



MALLET E 11

MALLET E



	black/gold	black	blue
code	16093	15990	15991
weight	385 g	419 g	419 g
price	€ 350	€ 169	€ 169

MALLET E LS (LONG SPINDLE)



	blue/black	silver/black
code	16080	16247
weight	424 g	424 g
price	€ 169	€ 169

THE MALLET COLLECTION



MALLET E LS // LIMITED EDITION



	silver/black	red/red	green/black
code	16204	16202	16203
weight	424 g	424 g	424 g
price	€ 169	€ 169	€ 169

MALLET 3

MALLET 2

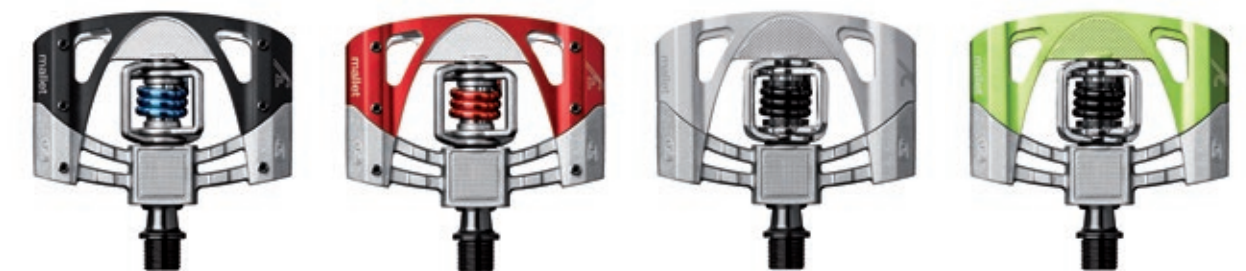

	black/raw/blue	red/raw/red	silver/raw/black	green/raw/black
code	15988	15989	15986	15987
weight	499 g	499 g	508 g	508 g
price	€ 139	€ 139	€ 100	€ 100

THE CANDY COLLECTION

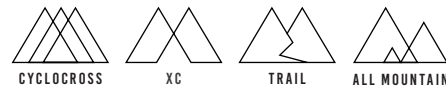

CANDY 11

CANDY 7

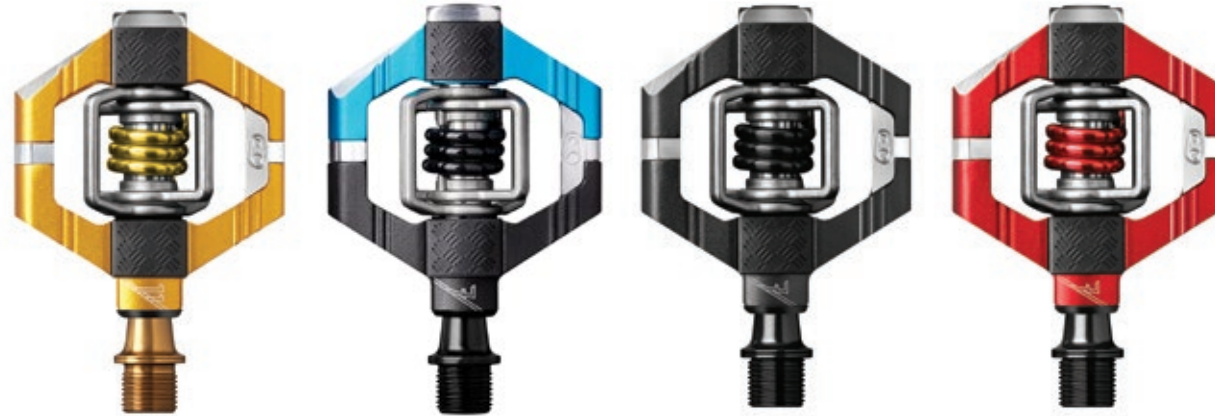

	gold	electric blue/black	black	red
code	15984	16178	15981	15982
weight	230 g	320 g	320 g	320 g
price	€ 450	€ 169	€ 169	€ 169

CANDY 3



	black	slate blue	dark red
code	16175	16176	16177
weight	340 g	340 g	340 g
price	€ 139	€ 139	€ 139



THE CANDY COLLECTION

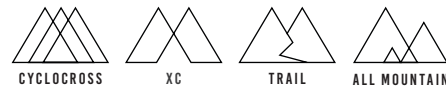

CANDY 2



	dark grey	green
code	16173	16174
weight	355 g	355 g
price	€ 100	€ 100

CANDY 1



	black	red	blue	pink
code	16169	16170	16171	16172
weight	294 g	294 g	294 g	294 g
price	€ 60	€ 60	€ 60	€ 60

THE EGGBEATER COLLECTION

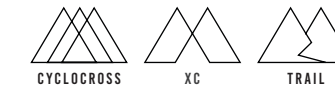

EGGBEATER 11

EGGBEATER 3

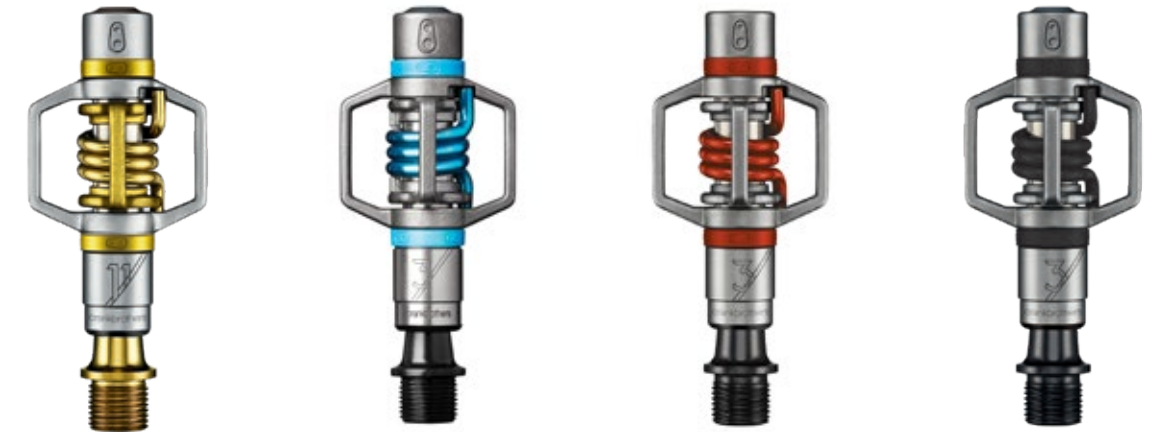

	gold	light blue/electric blue	red	black
code	11495	16098	15319	15859
weight	179 g	280 g	280 g	280 g
price	€ 450	€ 139	€ 139	€ 139

EGGBEATER 2

EGGBEATER 1



	black	black/green	silver/black	silver/red
code	15317	15985	14791	14792
weight	285 g	285 g	290 g	290 g
price	€ 100	€ 100	€ 60	€ 60

**I PIEDI DEI CICLISTI HANNO TAGLIE DIVERSE, E COSÌ ANCHE I PEDALI
LA TAILLE DE PIEDS DE CHAQUE PILOTE EST DIFFERENTE... DONC, LEURS PÉDALES**

**ABBIAMO ANALIZZATO LE SUOLE DEI PIÙ IMPORTANTI PRODUTTORI DI SCARPE PER MTB
NOUS AVONS ANALYSÉ LES PROFILS DE SEMELLES DES GRANDES MARQUES DE CHAUSSURES VTT**

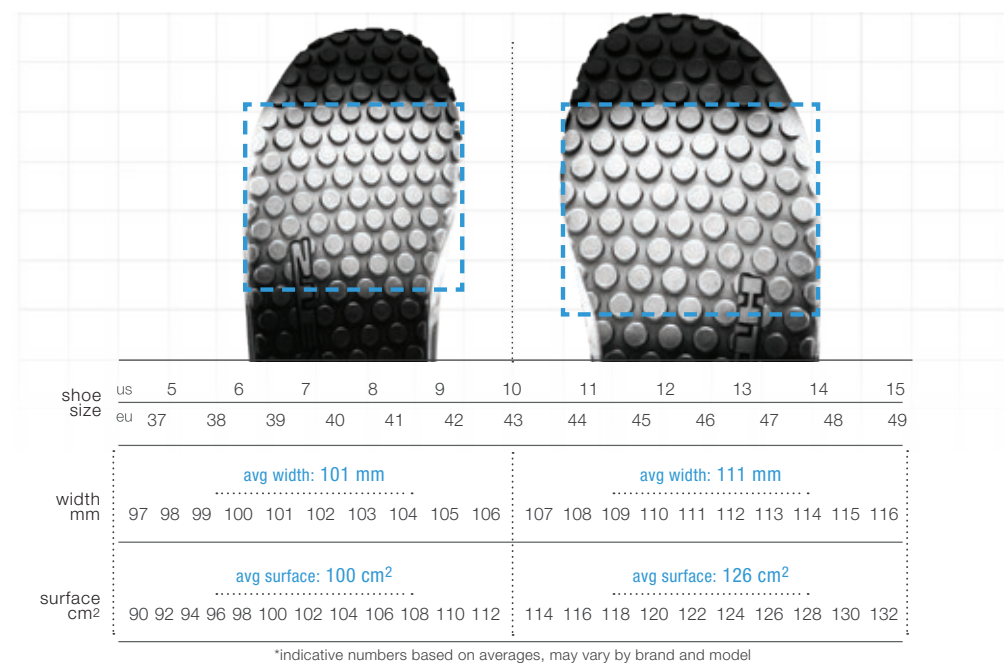

SUPERFICIE OTTIMALE | SURFACE OPTIMALE

- Basato sull'analisi delle misure delle scarpe e della superficie delle soles
- Due misure, ciascuna con una superficie ottimizzata in base alla taglia
- Aumento del grip, del supporto e del contatto con il pedale
- Riduce il peso e l'area d'impatto con le rocce

- Basée sur l'analyse des dimensions des chaussures et la surface des semelles
- Deux différentes tailles avec des surfaces optimales pour les diverses gammes de tailles de chaussures
- Optimise l'adhérence, le support et l'interface avec la pédale
- Réduit considérablement le poids et prévient des chocs avec le terrain

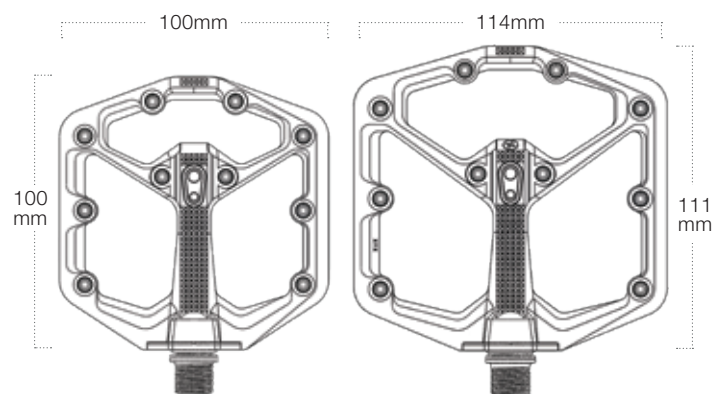

PROFILO MINIMAL/CONCAVITÀ MASSIMA | PROFIL MINIMAL/CONCAVITE MAXIMALE

- Profilo minimal, 11-13 mm
- Un profilo più fino rispetto alla concorrenza
- Riduce il peso e l'impatto con le rocce
- La piattaforma concava garantisce una presa più salda del piede sul pedale
- Una piattaforma più concava rispetto alla concorrenza

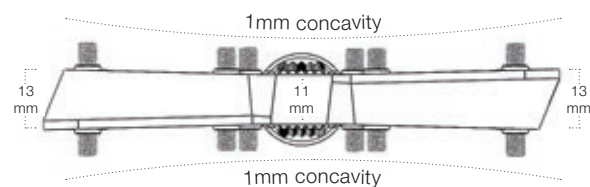

- Profil minimal, 11-13 mm
- Profil plus mince que les produits de la concurrence
- Réduit le poids et les chocs avec le terrain
- Plate forme concave, positionnement du pied plus sûr
- Concavité supérieure aux produits de la concurrence

THE STAMP COLLECTION



STAMP 11

STAMP 7



	large black	small black	large black	small black	large red	small red
code	16165	16166	16002	16004	16003	16005
weight	325 g	299 g	375 g	345 g	375 g	345 g
price	€ 300	€ 300	€ 150	€ 150	€ 150	€ 150

STAMP 3



	large black	small black	large blue	small blue	large Danny Macaskill	small Danny Macaskill
code	16102	16104	16103	16105	16213	16214
weight	455 g	399 g	455 g	399 g	455 g	399 g
price	€ 100	€ 100	€ 100	€ 100	€ 100	€ 100



THE STAMP COLLECTION



STAMP 2



// LIMITED EDITION

	large black	small black	large raw	small raw	large red	small red
code	16107	16109	16106	16108	16207	16208
weight	470 g	415 g	470 g	415 g	470 g	415 g
price	€ 80	€ 80	€ 80	€ 80	€ 80	€ 80

STAMP 1

NEW



	large black	small black	large red	small red	large blue	small blue
code	16267	16270	16268	16271	16269	16272
weight	329 g	299 g	329 g	299 g	329 g	299 g
price	€ 50	€ 50	€ 50	€ 50	€ 50	€ 50

THE 5050 COLLECTION



5050



	black/black
code	16219
weight	480 g
price	€ 60

THE DOUBLE SHOT COLLECTION



DOUBLE SHOT 3



flat side

clip side

flat side

clip side

	black	red/black
code	16111	16110
weight	403 g	403 g
price	€ 129	€ 129

THE DOUBLE SHOT COLLECTION



DOUBLE SHOT 2



	black/raw/blue	orange/black/orange	blue/black/black
code	16006	16007	16077
weight	395 g	395 g	395 g
price	€ 90	€ 90	€ 90

DOUBLE SHOT 1

NEW



	black/black	red/black	blue/black
code	16179	16180	16181
weight	331 g	331 g	331 g
price	€ 60	€ 60	€ 60

ACCESSORIES

STANDARD RELEASE 60° FLOAT CLEAT



gold

RELEASE: 15° FLOAT: 60°

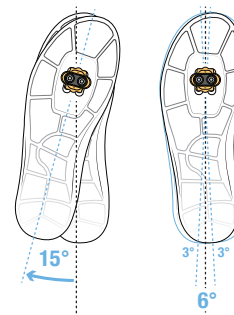

STANDARD RELEASE 0° FLOAT CLEAT



silver

RELEASE: 15° FLOAT: 0°

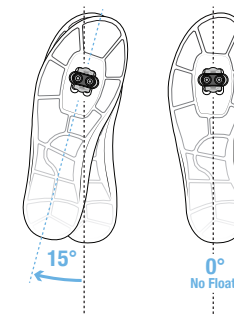

EASY RELEASE 60° FLOAT CLEAT



rose

RELEASE: 10° FLOAT: 60°

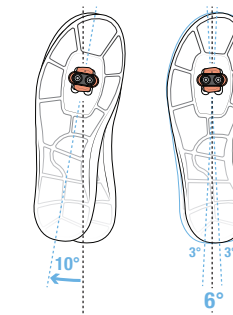

EASY RELEASE 0° FLOAT CLEAT



bronze

RELEASE: 10° FLOAT: 0°

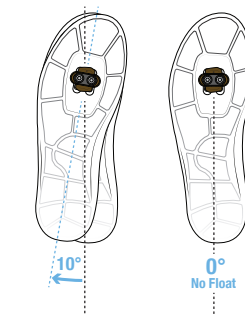

CLEAT ACCESSORIES

accessory	code	weight	price
standard release cleat - 6° / 15°	10060	30g per pr	€ 24,50
standard release zero float cleat - 0° / 15°	15338	30g per pr	€ 24,50
3-hole cleat kit	15289	86g per pr	€ 30,00
NEW easy release cleat - 6° / 10°	16275	30g per pr	€ 24,50
NEW easy release zero float cleat - 0° / 10°	16276	30g per pr	€ 24,50
shoe shields (pair)	10000	36g per pr	€ 10,00

SPINDLE UPGRADE KITS

kit	code	price
long spindle upgrade kit	16067	€ 50,00
titanium spindle upgrade kit	16068	€ 150,00

PEDAL REFRESH KITS

kit	code	price
2010-present	16051	€ 22,50
NEW candy 11 / eggbeater 11	16229	€ 22,50
NEW stamp 7/11	16273	€ 22,50
NEW double shot 2/3	16274	€ 22,50

TRACTION PADS

accessory	code	price
eggbeater 2/3/11	13281	€ 10,00
candy 2/3 (2010-2016)	13282	€ 10,00
candy 2/3 (2017+)	16217	€ 10,00
candy 7/11	16057	€ 15,00
mallet E / ELS / E11	16058	€ 15,00

MALLET / 5050 / STAMP PIN KITS

kit	code	price
8 mm pin kits	13891	€ 12,00
10 mm pin kit	13890	€ 12,00

SYNTHESIS

SISTEMA RUOTE PERSONALIZZATO | SYSTEME DE ROUES PERSONNALISEES

ANTERIORE E POSTERIORE SPECIFICI | AVANT ET ARRIERE SPECIFIQUES

STRUTTURA RUOTA ANTERIORE | STRUCTURE ROUE AVANT

- Ridotto numero di raggi
- Tensione sui raggi inferiore
- Raggi alleggeriti
- Cerchio alleggerito
- Canale del cerchio più largo
- Nombre de rayons réduit
- Tension des rayons inférieure
- Rayons allégés
- Jante allégée
- profil intérieur de la jante plus large

STRUTTURA RUOTA POSTERIORE | STRUCTURE ROUE ARRIÈRE

- Maggiore numero di raggi
- Tensione sui raggi maggiore
- Maggiore robustezza del raggio
- Cerchio più resistente
- Canale del cerchio più stretto
- Nombre de rayons plus élevés
- Tension des rayons supérieure
- Rayons renforcés
- Jante plus résistante
- Profil intérieur de la jante plus étroit

UNA RUOTA ANTERIORE MANEGGEVOLE | ROUE AVANT PLUS MANIABLE CONTROLLO NELLE CURVE | MAITRISE EN COURBE



MANEGGEVOLEZZA OTTIMIZZATA CONDUITE PLUS MANIABLE

- Smorza le vibrazioni sui trail
- Riduce la stanchezza del biker
- Attutisce e assorbe gli impatti
- Amortit les vibrations
- Réduit la fatigue du pilote
- Diminue et absorbe les chocs

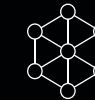

TRAIETTORIE SICURE TRAJECTOIRES MAITRISEES

- Migliora l'aderenza
- Migliora l'ingresso in curva in velocità
- Tiene la copertura attaccata al suolo
- Améliore l'adhérence
- Améliore la vitesse en courbe
- Maintient l'accroche du pneu au sol



CANALE DEL CERCHIO A LARGHEZZA MAGGIORATA PROFIL INTÉRIEUR DE LA JANTE PLUS LARGE

- Aumenta il volume d'aria della copertura per una migliore aderenza
- Il profilo arrotondato della copertura migliora le sterzate
- Supporta le coperture di grossa sezione sull'anteriore
- Augmentation du volume d'air du pneu améliorant l'adhérence
- Le profil arrondi du pneu facilite le guidage en virage
- Supporte le montage de pneus de grosse section sur la roue avant

UNA RUOTA POSTERIORE RIGIDA | UNE ROUE ARRIERE RIGIDE STABILITÀ E CONTROLLO IN VELOCITÀ | STABILITÉ ET CONTRÔLE À VITESSE ÉLEVÉE

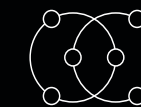

CARICHI DIREZIONALI / RADIALI TOLLERATI PERFETTAMENTE SUPPORTE PARFAITEMENT LES CHARGES DIRECTIONNELLES ET RADIALES

- Reattività
- Mantiene velocità e momento di inerzia
- Stabilità
- Tollera le compressioni
- Ancora il biker al centro di gravità
- Réactivité
- Vitesse maintenue et moment d'inertie
- Stabilité
- Absorbe les pics de compression
- Maintient le centre de gravité du pilote

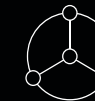

CANALE DEL CERCHIO PIÙ STRETTO PROFIL INTÉRIEUR DE LA JANTE PLUS ÉTROIT

- Riduce le pizzicature
- Migliora la resistenza al rotolamento
- Tassellatura più pronunciata per l'aderenza
- Réduit la zone de contact
- Diminue la résistance au roulement
- Améliore l'adhérence du pneu

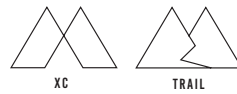

SYNTHESIS XCT

NEW

PRECISA IN VELOCITÀ | GUIDAGE PRECIS A HAUTE VITESSE

SYNTHESIS XCT 11

HUB CRANKBROTHERS PROJECT 321

ENGAGEMENT 2.5° QUIET ENGAGEMENT / MAGNETIC PAWLS

SPOKES AERO CX RAY / CX SPRINT

SYNTHESIS XCT

HUB CRANKBROTHERS STANDARD

ENGAGEMENT 17°

SPOKES DLIGHT / RACE



FRONT WHEEL

SPOKE COUNT: 28 INNER RIM WIDTH: 26.5

REAR WHEEL

SPOKE COUNT: 32 INNER RIM WIDTH: 24.5

FRONT WHEEL

SPOKE COUNT: 28 INNER RIM WIDTH: 26.5

REAR WHEEL

SPOKE COUNT: 32 INNER RIM WIDTH: 24.5

	synthesis XCT 11 : 29"	synthesis XCT 11 : 29"	synthesis XCT : 29"	synthesis XCT : 29"
code	16299	16300	16301	16302
driver body	xd	shimano	xd	shimano
weight	1473g	1490g	1557g	1557g
diameter	29"	29"	29"	29"
hub	boost	boost	boost	boost
front axle	110x15mm	110x15mm	110x15mm	110x15mm
rear axle	148x12mm	148x12mm	148x12mm	148x12mm
rim	carbon premium	carbon premium	carbon	carbon
price	€ 2400	€ 2400	€ 1699	€ 1699



SYNTHESIS E

NEW

CONTROLLO E STABILITÀ PER L'ENDURO | CONTRÔLE ET STABILITÉ EN PRATIQUE ENDURO

SYNTHESIS E 11

HUB CRANKBROTHERS PROJECT 321

ENGAGEMENT 2.5° QUIET ENGAGEMENT / MAGNETIC PAWLS

SPOKES AERO CX RAY / CX SPRINT

SYNTHESIS E

HUB CRANKBROTHERS STANDARD

ENGAGEMENT 17°

SPOKES DLIGHT / RACE



FRONT WHEEL

SPOKE COUNT: 28 INNER RIM WIDTH: 31.5

REAR WHEEL

SPOKE COUNT: 32 INNER RIM WIDTH: 29.5

FRONT WHEEL

SPOKE COUNT: 28 INNER RIM WIDTH: 31.5

REAR WHEEL

SPOKE COUNT: 32 INNER RIM WIDTH: 29.5

	synthesis E 11 : 27.5"	synthesis E 11 : 27.5"	synthesis E 11 : 29"	synthesis E 11 : 29"	synthesis E : 27.5"	synthesis E : 27.5"	synthesis E : 29"	synthesis E : 29"
code	16285	16286	16289	16290	16287	16288	16291	16292
driver body	xd	shimano	xd	shimano	xd	shimano	xd	shimano
weight	1764g	1785g	1829g	1829g	1848g	1848g	1908g	1908g
diameter	27.5"	27.5"	29"	29"	27.5"	27.5"	29"	29"
hub	boost	boost	boost	boost	boost	boost	boost	boost
front axle	110x15mm	110x15mm	110x15mm	110x15mm	110x15mm	110x15mm	110x15mm	110x15mm
rear axle	148x12mm	148x12mm	148x12mm	148x12mm	148x12mm	148x12mm	148x12mm	148x12mm
rim	carbon premium	carbon premium	carbon premium	carbon premium	carbon	carbon	carbon	carbon
price	€ 2400	€ 2400	€ 2400	€ 2400	€ 1699	€ 1699	€ 1699	€ 1699

WHEELSETS



SYNTHESIS DH 11

NEW

OTTIMIZZATA PER SUPERARE I LIMITI | OPTIMISEE POUR DEPASSER VOS LIMITES

SYNTHESIS DH 11

HUB CRANKBROTHERS PROJECT 321

ENGAGEMENT 2.5° QUIET ENGAGEMENT / MAGNETIC PAWLS

SPOKES AERO CX RAY / CX SPRINT



FRONT WHEEL

SPOKE COUNT: 32
INNER RIM WIDTH: 31.5



REAR WHEEL

SPOKE COUNT: 32
INNER RIM WIDTH: 31.5

	synthesis DH 11 : 27.5"	synthesis DH 11 : 27.5"	synthesis DH 11 : 27.5"	synthesis DH 11 : 27.5"	synthesis DH 11 : 29"	synthesis DH 11 : 29"
code	16293	16294	16295	16296	16297	16298
driver body	xd	shimano	xd	shimano	xd	shimano
weight	1955g	1955g	1955g	1955g	2049g	2049g
diameter	27.5"	27.5"	27.5"	27.5"	29"	29"
hub	boost	boost	standard	standard	boost	boost
front axle	110x15mm	110x15mm	110x20mm	110x20mm	110x15mm	110x15mm
rear axle	148x12mm	148x12mm	150x12mm	150x12mm	148x12mm	148x12mm
rim	carbon premium	carbon premium	carbon premium	carbon premium	carbon premium	carbon premium
price	€ 2400	€ 2400	€ 2400	€ 2400	€ 2400	€ 2400



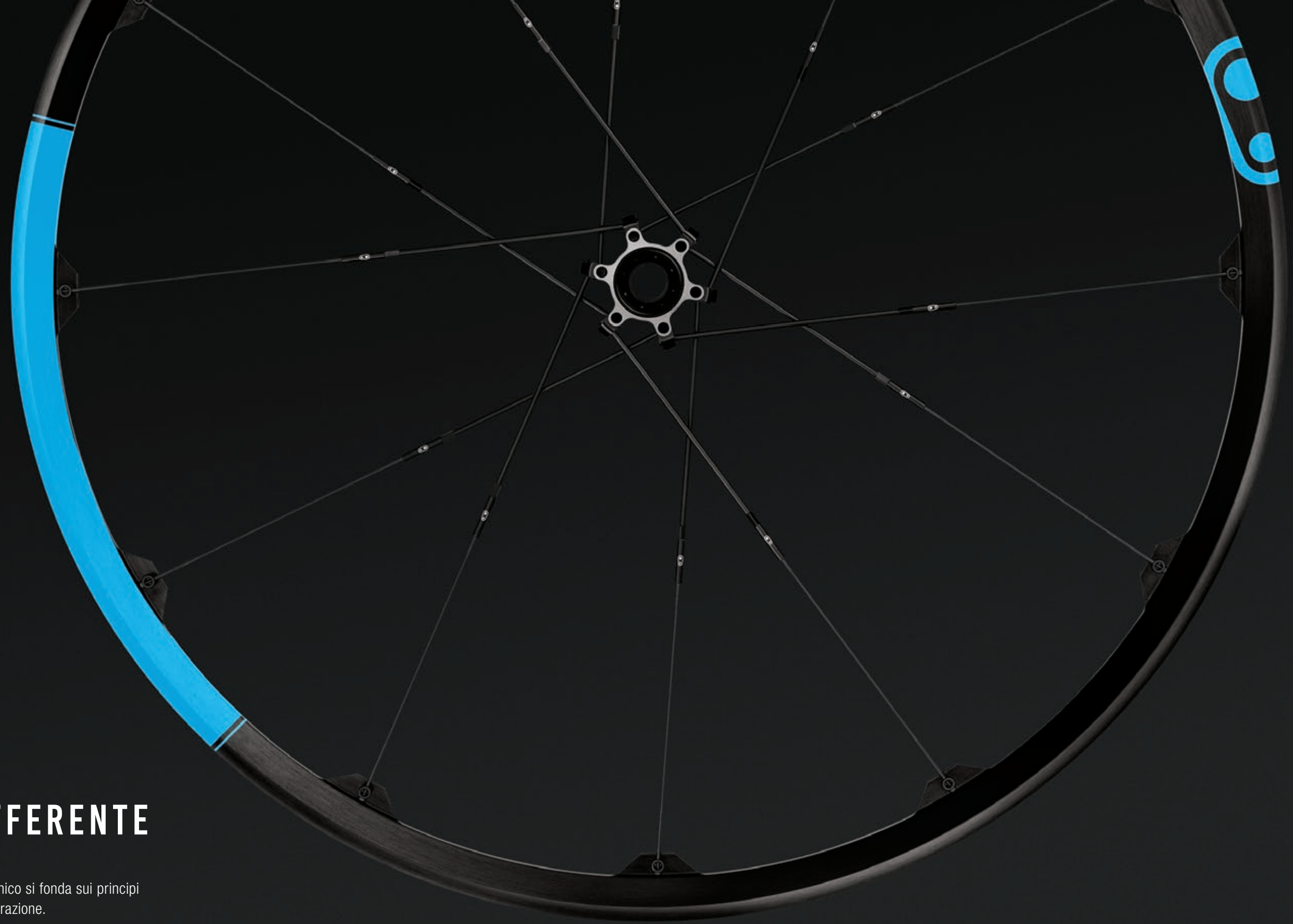

TOTALMENTE DIFFERENTE

Semplice e bella, la nostra ruota dal design unico si fonda sui principi di resistenza, rigidità e accelerazione.

TOTALEMENT DIFFÉRENTE

Notre roue est simple et belle, d'un design unique et réalisée en partant des principes de résistance, de rigidité et de réactivité.

PIÙ VELOCE PER UNA ACCELERAZIONE PIÙ RAPIDA PLUS RAPIDE POUR UNE PLUS FORTE ACCELERATION

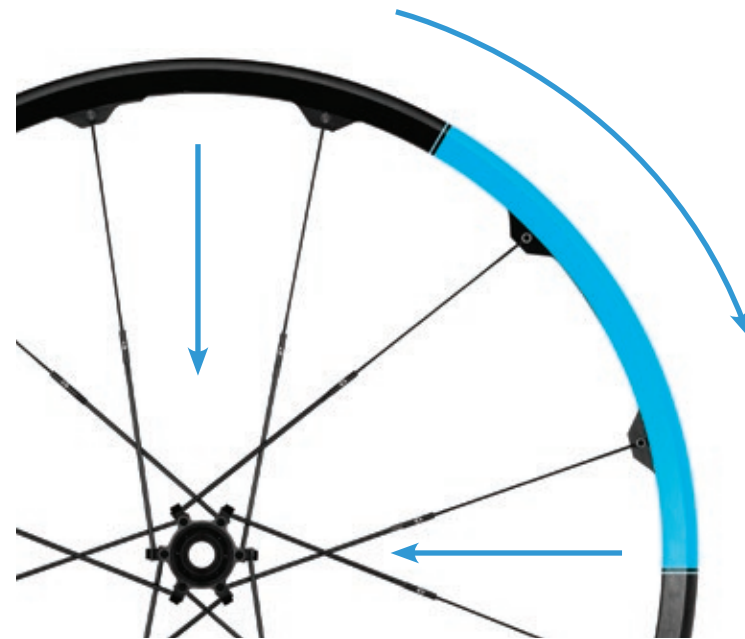

BASSA INERZIA DI ROTAZIONE

Ruote dal design unico, la massa è distribuita più vicino al mozzo, così da garantire più velocità in accelerazione e decelerazione.

TUBELESS READY

Il cerchio hole-less è più forte e non ha bisogno del rim tape per il montaggio dei tubeless.

FAIBLE INERTIE DE ROTATION

Conception de roue unique, distribue la masse au plus prêt du moyeu augmentant la rapidité d'accélération et de décélération.

TUBELESS PRÊT

Pas de trous de jantes, augmentant ainsi la résistance et pas de fond de jante nécessaire pour le montage de pneus tubeless.

ROBUSTO E RIGIDO | ROBUSTE ET PLUS RIGIDE

TECNOLOGIA RAGGI TWINPAIR

Progettata utilizzando la forma più resistente, il triangolo, per aumentare resistenza e rigidità.

MERAVIGLIOSAMENTE SEMPLICE

Raggi di un'unica lunghezza: facili da rimuovere e da sostituire senza dover togliere il copertone.

MONTAGE RAYONS "TWIN PAIR"

Conçu en utilisant le montage rayons en triangle afin d'optimiser résistance et rigidité.

MERVEILLEUSEMENT SIMPLE

Une seule longueur de rayon facilitant le remplacement sans démonter le pneu.



PROFILI DEI CERCHI PIÙ AMPI | PROFILS DE JANTE PLUS LARGE

PROFILI DEI CERCHI PIÙ AMPI PER UNA MIGLIORE TRAZIONE | PLUS LARGE POUR UNE MEILLEURE TRACTION



LARGHEZZA DEL CERCHIO

Mantenere il miglior rapporto tra la larghezza e il peso del cerchio consente di trovare la massima trazione ampliando la scelta degli pneumatici.

LARGEUR DE LA JANTE

L'équilibre parfait de la largeur et du poids permet une traction maximale et l'adaptation d'une vaste gamme de largeurs de pneus.

PROFILO OTTIMIZZATO

Il profilo del cerchio è stato ottimizzato per aumentare il volume d'aria all'interno dello pneumatico, garantendo quindi un miglior grip con il terreno sia in accelerazione che in frenata, in salita come in curva.

PROFIL DE PNEUMATIQUES OPTIMALES

Augmentation du volume d'air pour un meilleur amorti, un contact maximal de la bande de roulement améliorant le grip au freinage et dans les courbes. Optimise l'accroche en montée.

MOZZI MIGLIORATI | MOYEUX AMELIORES

PESO RIDOTTO, MONTAGGIO PIÙ RAPIDO | POIDS RÉDUIT, ENGAGEMENT PLUS RAPIDE

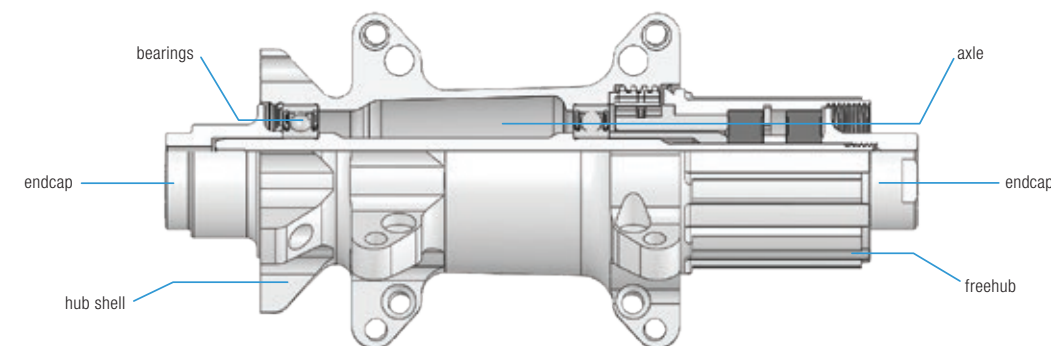

PESO RIDOTTO

Una riduzione significativa del peso è stata raggiunta attraverso l'alleggerimento di alcune aree chiave come i cuscinetti, i distanziali, i mozzi, la ruota libera e i perni.

POIDS RÉDUIT

Réduction significative du poids grâce à l'allègement de certains composants comme les roulements, les entretoises, le corps du moyeu, le porte cassette et l'axe.

LITHIUM

BUILT FOR E-MTB

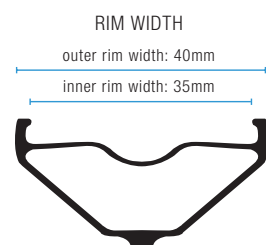

LITHIUM 27.5+

NEW



ELECTRIC



CARATTERISTICHE PRINCIPALI:

- raggi più resistenti - da 2.0 mm, a testa dritta
- profilo del cerchio maggiorato (canale da 35 mm/larghezza da 40 mm)
- ruota libera ed assale in acciaio
- profilo del cerchio rinforzato
- tecnologia del raggio accoppiato
- tubeless ready
- 2 anni di garanzia

PRINCIPALES CARACTÉRISTIQUES:

- rayons renforcés – section de 2.0 à tête droite
- profil de jante (35mm intérieur/40mm extérieur)
- roue libre et axes acier
- montage rayonnage technologie twin pair
- profil de jante renforcé
- tubeless ready
- 2 ans de garantie

I BENEFICI DELLE RUOTE SPECIFICHE PER LE E-BIKE | AVANTAGES DES ROUES SPÉCIFIQUES POUR E-BIKES

PARAGONATA A UNA MTB TRADIZIONALE UNA E-MTB PESA DI PIÙ E SUBISCE MAGGIORI STRESS.
PER QUESTO NECESSITA DI UN SISTEMA RUOTE PIÙ ROBUSTO.

PAR RAPPORT À UN VTT STANDART, UN VTT À ASSISTANCE ÉLECTRIQUE OFFRE UN POIDS BIEN PLUS ÉLEVÉ ET SUBIT DES CHARGES DE PUISSANCE PLUS IMPORTANTES, D'OU LA NÉCESSITÉ DE L'ÉQUIPER DE ROUES PLUS RÉSISTANTES ET ROBUSTES.

	lithium 27.5 +
code	16249
color	gloss black/black
weight	2085 g
diameter	27.5"
front axle	15x110 mm
rear axle	148x12 mm
price	€ 779

COBALT 3

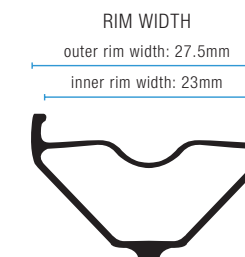
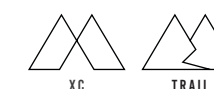

COBALT 3, ALUMINUM

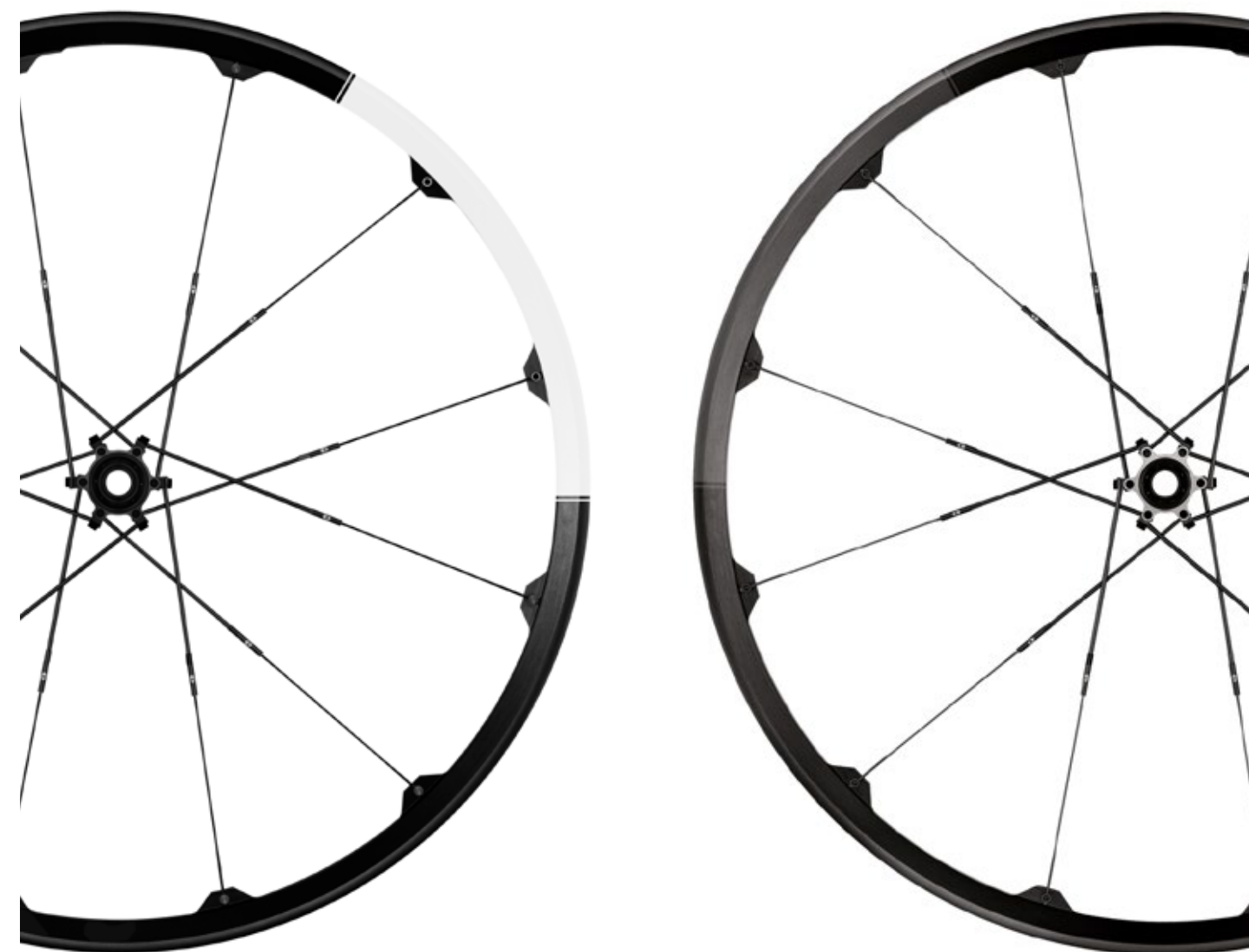

	cobalt 3 : 29"	cobalt 3 boost : 29"	cobalt 3 boost : 27.5"	cobalt 3 : 29"	cobalt 3 boost : 29"	cobalt 3 : 27.5"
code	16127	16129	16130	16155	16156	16157
color	black/white	black/white	black/white	matt black/black	matt black/black	matt black/black
weight	1735 g	1735 g	1650 g	1735 g	1735 g	1650 g
diameter	29"	29"	27.5"	29"	29"	27.5"
front axle	15x100 mm	15x110 mm	15x110 mm	15x100 mm	15x110 mm	15x110 mm
rear axle	142x12 mm	148x12 mm	148x12 mm	142x12 mm	148x12 mm	148x12 mm
price	€ 779	€ 779	€ 779	€ 779	€ 779	€ 779

COBALT 2

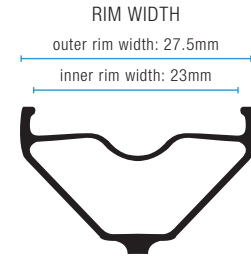
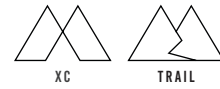

COBALT 2, ALUMINUM



	cobalt 2 : 29"	cobalt 2 boost : 29"	cobalt 2 boost : 27.5"
code	16140	16141	16142
color	black/grey	black/grey	black/grey
weight	1790 g	1790 g	1710 g
diameter	29"	29"	27.5"
front axle	15x100 mm	15x110 mm	15x110 mm
rear axle	142x12 mm	148x12 mm	148x12 mm
price	€ 579	€ 579	€ 579

COBALT 1

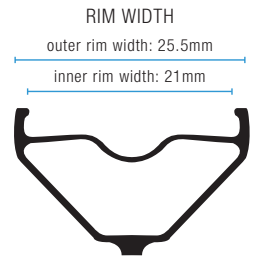
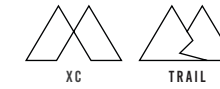

COBALT 1, ALUMINUM



	cobalt 1 : 29"	cobalt 1 : 27.5"
code	15876	15875
color	flat black	flat black
weight	1975 g	1900 g
diameter	29"	27.5"
front axle	15x100 mm	15x100 mm
rear axle	142x12 mm	142x12 mm
price	€ 399	€ 399

IODINE 3

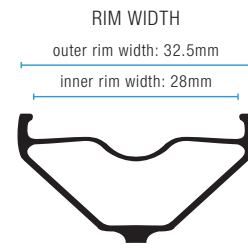
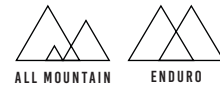

IODINE 3, ALUMINUM



	iodine 3 boost : 29"	iodine 3 : 27.5"	iodine 3 boost : 27.5"
code	16137	16136	16138
color	black/silver	black/silver	black/silver
weight	1830 g	1760 g	1760 g
diameter	29"	27.5"	27.5"
front axle	15x110 mm	15x100 mm	15x110 mm
rear axle	148x12 mm	142x12 mm	148x12 mm
price	€ 779	€ 779	€ 779

IODINE 2

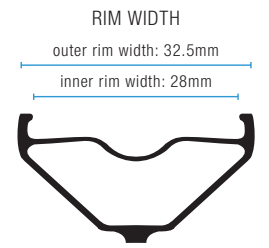

IODINE 2, ALUMINUM



	iodine 2 boost : 29"	iodine 2 : 27.5"	iodine 2 boost : 27.5"
code	16143	16144	16145
color	black/grey	black/grey	black/grey
weight	1900 g	1830 g	1830 g
diameter	29"	27.5"	27.5"
front axle	15x110 mm	15x100 mm	15x110 mm
rear axle	148x12 mm	142x12 mm	148x12 mm
price	€ 579	€ 579	€ 579

OPIUM

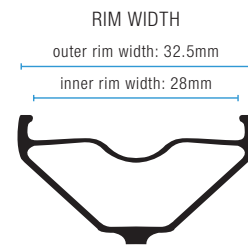

OPIUM DH, ALUMINUM



	opium : 29"	opium : 27.5"
code	16196	16190
color	black/red	black/red
weight	2175 g	2075 g
diameter	29"	27.5"
front axle	20x110 mm	20x110 mm
rear axle	150x12 mm	150x12 mm
price	€ 779	€ 779

ZINC 3

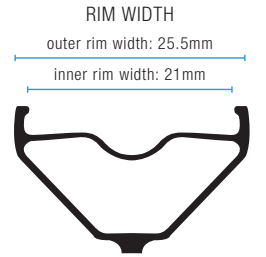
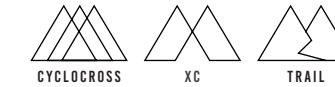

ZINC 3, ALUMINUM



	zinc 3 : 29"
code	16139
color	black/white
weight	1645 g
diameter	29"
front axle	15x100 mm
rear axle	142x12 mm
price	€ 779

WHEELSETS ACCESSORIES*

wheel kit	XC driver body for level 2, 3 & 11 (from range 2017)	Front adaptors for Cobalt, Iodine, Zinc			Rear adaptors for Cobalt, Iodine level 3/11	
		9 mm	15 mm	100X12 mm (+ axle kit)	135X10 mm	142X12 mm
codice	15538	99202	99203	99162	99204	99205
prezzo	€ 100	€ 20	€ 20	€ 20	€ 20	€ 20

* vedi listino per maggiori dettagli sugli adattatori / plus d'infos sur la liste de prix

servizio assistenza crankbrothers italia > vai a fine catalogo | service après vente crankbrothers > se rendre en fin de catalogue



HIGHLINE REGGISSELLA TELESCOPICO | TIGE DE SELLE TÉLESCOPIQUE

Guarnizioni d'alta gamma Trelleborg, cuscinetti e parti esclusive Iigus, cablaggi Jagwire, cartuccia idraulica indipendente e affidabile, prodotta da un'azienda leader. Novità per il 2018: inserzione nel tubo verticale più corta e aggiunta delle escursioni 150 e 170 mm.

Joint d'étanchéité haut de gamme Trelleborg, roulement spécifique igus, cable Jagwire et cartouche hydraulique de haute qualité produite par une usine leader. Innovation 2018: insertion plus courte dans le tube vertical plus 2 nouvelles extensions (150mm & 170mm).

- Peso: 580 g, inclusi controllo remoto, cavo e custodia
- 3 Escursioni 100 mm/125 mm/160 mm
- Diametro: 30,9, 31,6 mm
- Lunghezza: 400 mm
- Altezza minima: 50 mm
- Routing interno
- Meccanismo di connessione rapida per facilitare l'installazione del cavo
- Morsetto a sgancio rapido con doppio bullone per montare facilmente la sella
- Cavo jagwire® elite ultra-slick e custodia lex-sl
- Cartuccia idraulica interna
- Cuscinetti igus® II-glide
- Guarnizioni trelleborg®
- Garanzia di 3 anni

- Poids: 580 g tout compris (tige de selle, insert, commande, câblage)
- 3 extensions: 100mm / 125mm / 160mm
- Diamètre 30,9 et 31,6 mm
- Longueur: 400mm
- Hauteur minimum: 50mm
- Routage interne
- Mécanisme de connexion rapide pour faciliter l'installation du cable
- Facilité de montage de la selle par 2 boulons
- Câble elite ultra slick Jagwire et insert lex
- Cartouche hydraulique autonome
- Roulements igus LL glide
- Joints d'étanchéité Trelleborg
- Garantie 3 ans

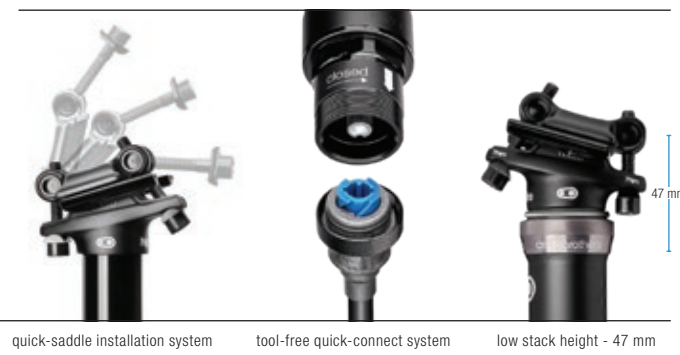

NEW NEW NEW NEW

code	16163	16164	16008	16009	16241	16240	16243	16242
color	black	black	black	black	black	black	black	black
weight	510g*	520g*	550g*	560g*	585g*	595g*	615g*	625g*
diameter	30,9 mm	31,6 mm	30,9 mm	31,6 mm	30,9 mm	31,6 mm	30,9 mm	31,6 mm
length	325 mm	325 mm	370 mm	370 mm	425 mm	425 mm	465 mm	465 mm
travel	100 mm	100 mm	125 mm	125 mm	150 mm	150 mm	170 mm	170 mm
price	€ 350	€ 350	€ 350	€ 350	€ 350	€ 350	€ 350	€ 350

*Il peso include il reggisella, il cavo e il controllo remoto. Per la guaina contare 25-60g in base alla lunghezza.

*Le poids comprend la tige de selle, la télécommande et le câble. Il faut ajouter de 25g à 60g en fonction de la longueur de la gaine.

IL CONTROLLO REMOTO PIÙ ERGONOMICO | LA PLUS ERGONOMIQUE

Il controllo remoto dell'HIGHLINE è caratterizzato da un sistema di regolazione sferico, con una capacità di rotazione quasi completa e la possibilità di regolare l'inclinazione per una perfetta ergonomia.

La comando de l'HIGHLINE se caractérise par un système d'ajustement sphérique unique en son genre. Idéale sur le plan ergonomique, elle permet à chaque pilote de la positionner sur le cintre à la position parfaite.

- La leva di controllo remoto a rotazione permette un posizionamento ergonomico ottimale
- Regolazione ergonomica a sfera - 360° di rotazione / 22° d'inclinazione
- Sistema di chiusura a cerniera a bullone unico
- Sistema di fissaggio universale: alto/basso/sinistro/destro
- Le levier permet un positionnement idéal sur le plan ergonomique
- Ajustement ergonomique sphérique: rotation de 360° / inclinaison de 22°
- Système de fixation charnière unique
- Système de montage universel: haut/bas/gauche/droite



HIGHLINE TRACTION TABS



	HIGHLINE remote only	HIGHLINE stickers kit
code	16066	16150
color	black	mixed colours
price	€ 60	€ 8

COBALT 11

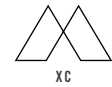

COBALT 11 20 MM SETBACK

COBALT 11 NO SETBACK



	27.2 mm - 400 mm	27.2 mm - 400 mm
code	15486	15485
color	black/gold	black/gold
price	€ 220	€ 220
	30.9 mm - 400 mm	30.9 mm - 400 mm
code	15490	15489
color	black/gold	black/gold
price	€ 220	€ 220
	31.6 mm - 400 mm	31.6 mm - 400 mm
code	15494	15493
color	black/gold	black/gold
price	€ 220	€ 220
weight	157 g (31.6 mm, no setback, 350 mm)	

COBALT 3

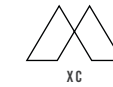

COBALT 3 20 MM SETBACK

COBALT 3 NO SETBACK



	27.2 mm - 400 mm	27.2 mm - 400 mm
code	15472	15471
color	black/red	black/red
price	€ 100	€ 100
	30.9 mm - 400 mm	30.9 mm - 400 mm
code	15474	15473
color	black/red	black/red
price	€ 100	€ 100
	31.6 mm - 400 mm	31.6 mm - 400 mm
code	15476	15475
color	black/red	black/red
price	€ 100	€ 100
weight	234 g (31.6 mm, no setback, 350 mm)	

COBALT



COBALT 11, CARBON



	680 mm
code	14899
height	low rise (15 mm)
weight	160 g (680 mm low rise)
color	black polish
price	€ 160

COBALT 3, ALUMINUM



	680 mm	700 mm	780 mm
code	14883	14897	14886
height	rise (8 mm)	rise (15 mm)	rise (8 mm)
weight	180 g (600 mm flat)	230 g (600 mm low rise)	180 g (600 mm flat)
color	black	black	black
price	€ 85	€ 85	€ 85

IODINE



IODINE 11, CARBON



	780 mm
code	14913
height	rise (31,8 mm)
weight	215 g
color	black
price	€ 160

IODINE 3, ALUMINUM



IODINE 2, ALUMINUM



	720 mm	780 mm
code	14908	15381
height	rise (31,8 mm)	rise (31,8 mm)
weight	290 g	360 g
color	black	black
price	€ 85	€ 50

COBALT & IODINE

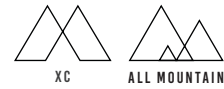

COBALT



130 mm

code	15279
weight	65 g
color	silver
price	€ 25



130 mm

code	14918
weight	65 g
color	gold
price	€ 25



130 mm

code	14919
weight	65 g
color	red
price	€ 25

IODINE



130mm

code	14920
weight	101 g
color	black
price	€ 25



SOTTILE, LEGGERO, MINIMALISTA

Perfetto. La nuova serie di tool F ha un design ricercato e fino a 15 utensili inseriti nella custodia magnetica pieghevole che ne garantisce dimensioni ultra ridotte.

ELEGANTE, LEGERE, MINIMALISTE

La nouvelle série "multi tools" F-SERIES se caractérise par un design recherché et élégant et des dimensions compactes. Elle peut offrir jusqu'à 15 outils contenus dans un boîtier magnétique.



MULTI TOOLS

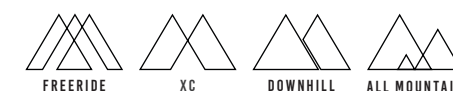

F-SERIES



// LIMITED EDITION

	f15 SYNDICATE red case	f15	f10+	f10
code	16227	16092	16091	16090
weight	164 g	164 g	116 g	94 g
price	€ 43	€ 43	€ 35	€ 30

B-SERIES



	b14	b8
code	14688	14687
weight	206 g	144 g
price	€ 28	€ 20

MULTI TOOLS

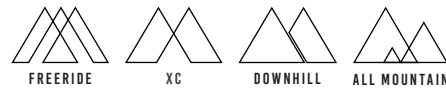

M-SERIES



	m19 (includes tool flask)	m17	m10	m5
code	10758	10755	10750	10745
weight	175 g w/out flask	168 g	124 g	85 g
color	gold	gold	gold	gold
price	€ 34	€ 28	€ 20	€ 13



	m19 (includes tool flask)	m17	m10	m5
code	11465	10752	10747	10743
weight	175 g w/out flask	168 g	124 g	85 g
color	nickel	nickel	nickel	nickel
price	€ 34	€ 28	€ 20	€ 13

Y16

Y15

Y12



	y16	y15	y12
code	15743	15938	15742
weight	260 g	224 g	166 g
color	silver	silver	silver
price	€ 50	€ 40	€ 30

MULTI TOOLS - LEVERS

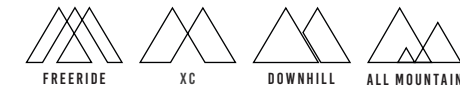

SEATPOST RAIL KIT

	7x9 seatpost rail kit
code	13780
color	black
price	€ 30



SPEEDIER LEVER

code	14499
weight	26 g
price	€ 6



SPEEDIER LEVER POP

code	14532
price	€ 144 / € 6 cad.
code	14498
price	€ 144 / € 6 cad.



THE WORKSHOP ESSENTIAL

Grazie alla manichetta integrata, la testa magnetica e il serbatoio removibile, la nostra nuova gamma di pompe è perfetta sia a casa che in officina per gonfiare qualsiasi ruota senza fatica.

THE WORKSHOP ESSENTIAL

Avec un embout logé dans le corps de la pompe, une tête magnétique et une poignée amovible, notre nouvelle ligne de pompes à pieds est parfaite pour l'atelier ou un usage personnel et permet à chacun de gonfler tout type de pneumatique sans effort.



POMPA A TERRA KLIC | POMPES A PIEDS KLIC

- Testa magnetica
- Manichetta integrata nel corpo della pompa
- Manometro veloce da installare
- Manichetta fermata magneticamente al corpo della pompa
- Treppiede per maggiore stabilità
- 160 Psi / 11 bar
- Serbatoio removibile
- Il serbatoio può essere rimosso per montare facilmente tubeless
- Il serbatoio può essere trasportato facilmente
- Testa universale presta/schrader
- Manometro intuitivo

- Tête magnétique
- Embout logé dans le corps de la pompe
- Rapidité d'installation du manomètre
- Embout fixé magnétiquement sur le corps de la pompe
- Trépied assurant une stabilité parfaite
- 160 psi / 11 bar
- Réservoir amovible
- Le réservoir peut être chargé pour monter et gonfler les pneus tubeless
- Le réservoir est amovible pour transporter facilement séparément si désiré
- Tête universelle Presta / Schrader
- Manomètre

SERBATOIO REMOVIBILE RÉSERVOIR AMOVIBLE

Installa e gonfia coperture tubeless con facilità.

montage et gonflage des pneus tubeless aisé.



TUBO NASCOSTO TUYAU FLEXIBLE INTÉGRÉ

Viene riposta ordinatamente quando non utilizzata.

rangement pratique des éléments dans le corps de la pompe, après utilisation.



CONNESSIONE MAGNETICA VELOCE CONNECTION MAGNÉTIQUE ULTRA RAPIDE

Interfaccia facile per il beccuccio e per il serbatoio.

interface tuyau flexible/réservoir facile.



KLIC



NEW

pump w/digital gauge + canister



pump w/analog gauge + canister



only pump w/analog gauge

code	16197	16198	16200
weight	160 psi / 11 bar	160 psi / 11 bar	160 psi / 11 bar
price	€ 230	€ 200	€ 100

POMPA A TERRA STERLING | POMPES A PIEDS STERLING

- Interruttore alta pressione/alto volume attivabile con il piede
- Base in alluminio per stabilità e leggerezza
- Corpo e base in alluminio resistenti alla corrosione
- Testa intelligente: presta & schrader ready
- Manometro bar / psi

- Activation par pied de l'interrupteur haute pression / haut volume
- Base aluminium, légère et stable
- Corps et base aluminium, robuste et résistant à la corrosion
- Tête compatible Presta et Schrader
- Manomètre bar / psi

STERLING



silver

code	16168
weight	160 psi / 11 bar
head	universal presta / schrader
base	alloy
price	€ 70

SAPPHIRE

NEW



silver

midnight black

code	16304	16303
weight	160 psi / 11 bar	160 psi / 11 bar
head	universal presta / schrader	universal presta / schrader
base	steel	steel
price	€ 50	€ 50

GEM



black



green



red

code	16218	16206	16205
weight	160 psi / 11 bar	160 psi / 11 bar	160 psi / 11 bar
head	2 stage presta/schrader	2 stage presta/schrader	2 stage presta/schrader
base	steel	steel	steel
price	€ 50	€ 50	€ 50

POMPE A MANO KLIC | POMPE A MAIN KLIC

- Manichetta flessibile integrata
- Testa magnetica con collarino orientabile per evitare allo sporco di penetrare
- Manichetta magnetica per installare velocemente la testa
- Testa intelligente presta e schrader ready
- Maniglia pieghevole e bloccabile
- Manometro incorporato in alcuni modelli
- Adattatore CO2 integrato in alcuni modelli
- Adattore per il montaggio sul telaio compreso su tutti i modelli
- 5 Anni di garanzia

- Raccord de pompe flexible logé dans le corps (sur tous les modèles)
- Tête magnétique orientable évitant la pénétration de saletés
- Rapidité et facilité d'installation du raccord de pompe grâce à son extrémité magnétique
- Compatible Presta / Schrader
- Poignée de pliage et de verrouillage sur tous les modèles
- Manomètre incorporé sur certains modèles
- Adaptateur CO2 incorporé dans la poignée, sur certains modèles
- Toutes les pompes sont livrées avec support de fixation au cadre
- Garantie 5 ans

PRESTA / SCHRADER READY

Svita e inverte la testa per passare da Presta a Schrader.

Dévisser la tête pour basculer entre Presta et Schrader.



MANOMETRO | MANOMÈTRES

Preciso e facile da leggere.

Jauge très précise et facile à lire.

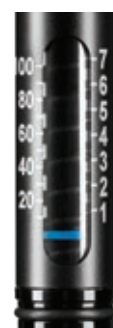
TESTA MAGNETICA ORIENTABILE
TÊTE MAGNETIQUE ORIENTABLE

Testa magnetica orientabile a 360 gradi per evitare allo sporco di penetrare. Manichetta magnetica per installare la testa velocemente.

Tête magnétique orientable à 360° évitant la pénétration de saletés.
Extrémité du raccord magnétique permettant un montage rapide et facile sur la tête.

MANICHETTA FLESSIBILE/MANIGLIA BLOCCABILE /ADATTATORE CO2
RACCORD FLEXIBLE ET ADAPTATEUR CO2 INCORPORE DANS LA POIGNE

La maniglia pieghevole permette di estrarre la manichetta. La testa magnetica con collarino orientabile per evitare allo sporco di penetrare. Adattatore CO2 integrato in alcuni modelli.

Déverrouillage de la poignée pliable pour extraire le raccord. Tête magnétique orientable évitant la pénétration de saletés.
Adaptateur CO2 intégré sur certains modèles.



COLLEZIONE POMPE A MANO KLIC | COLLECTION POMPES A MAIN KLIC

KLIC HP



	hp	hp gauge	hp w/co2	hp gauge w/co2 inflator
code	16112	16114	16216	16116
weight	115 g	142 g	142 g	170 g
color	silver/black	silver/black	silver/black	silver/black
price	€ 37	€ 47	€ 47	€ 57

KLIC HV



	hv	hv gauge	hv w/co2	hv gauge w/co2 inflator
code	16113	16115	16215	16117
weight	124 g	150 g	142 g	186 g
color	silver/black	silver/black	silver/black	silver/black
price	€ 37	€ 47	€ 47	€ 57

HAND PUMPS

COLLEZIONI POMPE A MANO STERLING E GEM | COLLECTIONS POMPES A MAIN STERLING ET GEM

Pompa premium, con adattatore alta pressione/alto volume brevettato per un gonfiaggio facilitato. Testa intelligente che si adatta automaticamente alla valvola presta o schrader. Disponibile in due lunghezze, con o senza manometro.

Pompes premium avec interrupteur haute pression / haut volume breveté, pour un gonflage facile. Embout compatible pour adaptation sur valve Presta ou Schrader. Disponible en deux longueurs, avec ou sans manomètre.

STERLING GAUGE LONG



sterling lg

code	14679
weight	173 g
color	silver/black
price	€ 50

STERLING GAUGE SHORT



sterling sg

code	14677
weight	141 g
color	silver/black
price	€ 45

STERLING NO GAUGE LONG



sterling l

code	14678
weight	143 g
color	silver/black
price	€ 40

STERLING NO GAUGE SHORT



sterling s

code	14676
weight	116 g
color	silver/black
price	€ 35

Testa convertibile schrader / presta e adattatore alta pressione / alto volume brevettato.

Embout compatible Presta / Schrader breveté, et interrupteur haute pression / haut volume pour un gonflage facile.

GEM L



green

code	14686
weight	155 g
price	€ 28



silver

code	14682
weight	155 g
price	€ 28



red

code	14684
weight	155 g
price	€ 28

GEM S



green

code	14685
weight	128 g
price	€ 22



silver

code	14681
weight	128 g
price	€ 22



red

code	14683
weight	128 g
price	€ 22

C02
// NEW



C02

NEW



C02 16g cartridge

code	16230
quantity	(2 units) w/inflator
price	€ 16



C02 25g cartridge

code	16232
quantity	(2 units) w/inflator
price	€ 20



C02 16g bulk pack

code	16233
quantity	30 pieces
price	€ 90

C02 25g bulk pack

code	16235
quantity	20 pieces
price	€ 100



Continental 

AG2R LA
MONDIALE

ROSTI

FACTOR

CONTINENTAL

SPECIAL SERVICE COURSES

MAVIC

fizik

SRM POWER

COMPETITION

MAVIC

PROLTO

TECNOLOGIA MADE IN GERMANY



Continental, l'unico produttore di pneumatici in Germania. "Fatto a mano in Germania" significa che gli pneumatici sono prodotti nel nostro stabilimento di Korbach, la maggior parte a mano e con un'alta proporzione di lavoro manuale, dal design della gomma al controllo di qualità finale. Per te questo significa offrire ai tuoi clienti pneumatici con tecnologia tedesca, così come accade dal 1871.

I prodotti realizzati a Korbach sono contrassegnati con il rispettivo simbolo nelle pagine seguenti.



La miscela per copertura unica nel suo genere, prodotta solo in Germania, che rivoluzionerà gli pneumatici per biciclette! Con la BlackChili Compound il compromesso tra maggior grip e bassa resistenza al rotolamento è stato portato ai massimi livelli in assoluto. I tanti primati ottenuti nei test certificano vantaggi misurabili e registrabili sia in laboratorio che sulla strada. I polimeri di nuova generazione, il particolato carbonioso frutto di nanotecnologie e gli agenti di carica garantiscono una performance davvero unica. Rappresenta il non plus ultra nei relativi ambiti di utilizzo: dalle coperture delle MTB da downhill agli pneumatici per bici da cronometro. BlackChili Compound migliora la resistenza al rotolamento del 26 per cento e offre allo stesso tempo un grip superiore di circa il 30 per cento rispetto alle mescole di silice attivato. Inoltre, gli pneumatici realizzati con il BlackChili Compound offrono una resa chilometrica superiore e, diversamente da mescole multiple, una performance costante dal primo all'ultimo chilometro.



I vantaggi di VectranTM. VectranTM viene prodotto dal polimero a cristalli liquidi Vectra. Si ottiene un filato termoplastico a fibre multiple. Questo tessuto in parte cristallino è più resistente al taglio rispetto all'aramide, è dotato di una resistenza alla trazione cinque volte superiore dell'acciaio ed è allo stesso tempo più leggero di un corrispondente filo di nylon. VectranTM mantiene queste caratteristiche anche nelle condizioni climatiche più ostili.



Resistente alla foratura. Con il PolyX Breaker® applichiamo il know-how acquisito in ambito automobilistico nel segmento motociclistico agli pneumatici per biciclette: sugli pneumatici per autovettura il poliestere viene utilizzato da anni, con grande successo ed esiti molto positivi. Estremamente resistente, la fibra di poliestere viene tessuta a maglie strette incrociate; in questo modo si raggiunge un'elevata densità del tessuto che rende il PolyX Breaker® non solo resistente alla perforazione da parte di corpi estranei ma anche particolarmente protettivo verso le forature.



Un vero duro. Le nuove carcasse Continental ProTecton sono state ottimizzate al massimo. L'ulteriore strato protettivo antiforatura applicato su tutta la circonferenza rende questo pneumatico particolarmente robusto e resistente nei confronti dei colpi e della penetrazione di corpi estranei. Per massimizzarne i vantaggi abbiamo combinato la carcassa ProTecton con la miscela BlackChili Compound, per ottenere così versatilità, peso contenuto e un design accattivante. Inoltre, grazie al nuovo rivoluzionario tallone, le ProTecton possono essere utilizzate anche come pneumatici tubeless ready.



Leggero, veloce, sicuro. Progettate senza scendere a compromessi per l'utilizzo su biciclette mountain bike da competizione, le carcasse RaceSport abbinano rigorosamente una costruzione leggera a un'eccellente protezione dalle forature. L'abbinamento fa la differenza: una tela di nylon molto fine e di alta qualità viene gommata per una protezione perfetta e poi completata con un tallone universale. Insieme alla leggendaria BlackChili Compound rappresenta la soluzione ideale per l'XC-Race e le marathon!

TECHNOLOGIES MADE IN GERMANY



Continental est le seul producteur allemand de pneus en Allemagne. La mention "Handmade in Germany" indique que les pneus sont produits dans notre usine de Korbach, principalement à la main et avec une forte proportion de travail manuel, du design du pneu jusqu'au contrôle qualité final. Pour vous, cela signifie que vous allez offrir à vos clients des pneus de technologie allemande - une tradition depuis 1871. Les produits fabriqués à Korbach sont signalés par le symbole correspondant dans les pages suivantes.



A Korbach, en Allemagne, où se trouve le siège de notre département recherche et développement pour les pneus de vélos Continental, cela fait longtemps que nos ingénieurs se creusent la tête sur un problème fondamental concernant la structure d'un pneu. En effet, les qualités de roulement du mélange de caoutchouc d'un pneu sont définies, de façon déterminante, par l'interaction de trois facteurs: le frottement statique (adhérence), la résistance au roulement et la longévité. Le dilemme est le suivant: si on améliore l'un de ces facteurs, au moins un autre de ces facteurs va par contre se dégrader. Un pneu ayant une adhérence maximale s'use plus rapidement et roule moins vite. Inversement, si on confectionne un pneu qui est plus rapide ou qui dure plus longtemps, alors son adhérence diminue. Avec la technologie de pointe d'aujourd'hui, à savoir la gomme à silice activée, on avait déjà atteint un bon compromis. Mais nos concepteurs voulaient obtenir plus. En suivant des chemins tout nouveaux, ils ont réussi en 2008 à mettre au point un mélange de gomme révolutionnaire: c'était le premier pas vers ce que l'on connaît sous le nom de Black Chili. Ce mélange de gomme totalement nouveau est basé sur les connaissances les plus récentes fournies par la recherche sur les polymères et les matières premières.



La référence en matière de protection anti-crevaisin. VectranTM est un fil high-tech synthétique dont le modèle est pris dans la nature. Comme la soie d'araignée, VectranTM est un polymère de cristaux liquides [LPC]. VectranTM est tissé à partir du polymère à cristaux liquides Vectra et retravaillé en un réseau multifibres. La soie d'araignée et le composé VectranTM possèdent une énorme résistance aux déchirures pour un poids très limité. Exactement les caractéristiques qui conviennent pour être utilisées en dispositif anti-crevaisin dans un pneu Continental. VectranTM Breaker est plus léger, plus flexible et protège encore mieux des coupures qu'une protection anti-crevaisin en Nylon. La résistance au roulement n'est pas affectée par VectranTM Breaker.



Résistant aux perforations et aux coupures. Avec PolyX Breaker®, le savoir faire automobile est appliqué au domaine du vélo: le polyester est, depuis des années utilisé avec succès dans les pneus voitures et à fait ses preuves à de nombreuses reprises. Les fibres de polyester extrêmement résistantes sont étroitement et finement tissées en croix. De la sorte, on obtient un réseau très dense, qui rend le PolyX Breaker® non seulement résistant aux corps étrangers, mais également solide face aux perforations. Là aussi, la résistance au roulement n'est pas non plus affectée par PolyX Breaker®.



La manière forte. Les nouvelles carcasses Continental ProTecton n'ont jamais eu aussi belle allure. La bande de protection supplémentaire contre la crevaisin la rend particulièrement résistante en insensible aux lésions ou à la pénétration de corps étrangers. Bande de roulement et flancs sont protégés de la même manière. Elles sont pourtant plus légères de 25% et assurent une protection anti-crevaisin supérieure de 30% par rapport à leurs prédécesseurs armés de Duraskin®. Par ailleurs, elles améliorent une fois de plus la résistance au roulement et l'amortissement. La nouvelle technologie "made in Germany" leur permet même de résister aux "trails" les plus durs du monde. Et elles ont encore un atout en poche: d'usage universel, elles séduisent de surcroît par le BlackChili Compound et le design attrayant des flancs. Le nouveau talon Revolution Tubeless Ready facilite l'utilisation en pneu Tubeless Ready. Pour des résultats idéaux de colmatage et de mise en oeuvre, nous recommandons d'utiliser le nouveau produit d'étanchéité Continental RevoSealant.



Léger, rapide et sûr. Conçus sans compromis pour être utilisés en compétition VTT: les carcasses RaceSport associent une grande légèreté de fabrication à un niveau maximal de résistance aux crevaisins. En coopération avec des grands noms du VTT professionnel. Nous avons ainsi créé la base de départ idéale pour des pneus course. Faits main en Allemagne. Elles assurent une protection anti-crevaisin supérieure de 30% à celle des pneus Supersonic. C'est la structure qui fait la différence - un tissu nylon de haute qualité particulièrement fin avec un revêtement protecteur en caoutchouc très élaboré et un talon universel. Conjointement au mélange légendaire BlackChili, c'est la combinaison dernier cri pour les courses XC et le marathon.

Pneumatici tubolari Continental

- › undici dei dodici pneumatici prodotti nel nostro stabilimento di Korbach sono fatti a mano
- › la camera d'aria è cucita direttamente sulla carcassa con circa 400 punti
- › tecnologia tedesca che coinvolge tutta la struttura e la costruzione dello pneumatico
- › conformi al 100 % ai controlli di qualità

Vantaggi

- › leggero: peso inferiore a uno pneumatico copertoncino
- › veloce: alte velocità grazie alla bassa resistenza al rotolamento
- › adattabilità: può essere utilizzato con alte pressioni di esercizio
- › sicuro: nel caso di foratura durante l'utilizzo lo pneumatico non uscirà dalla gola del cerchio: perfetto per la competizione. Chiedilo ai professionisti!

PASSIONE E PRECISIONE

Solo i materiali di altissima qualità sono usati per produrre i nostri tubolari. I singoli elementi sono combinati e uniti con precisione. I ciclisti più famosi al mondo mettono tutta la loro fiducia nel nostro lavoro. Che sia strada o pista, i tubolari prodotti da Continental hanno lasciato il loro segno nelle competizioni in giro per il mondo.

PRÉCISION ET PASSION

Nous n'utilisons que des matières premières de qualité supérieure pour fabriquer nos pneus tubulaires. Les divers éléments sont ensuite assemblés entre eux avec le plus grand soin. Les meilleurs cyclistes nous font confiance: que ce soit sur route ou sur piste, les pneus tubulaires Continental ont laissé leur empreinte dans les compétitions à travers le monde.

Pneus boyaux Continental

- › Onze des douze pneus que nous produisons dans notre usine de Korbach sont fabriqués à la main
- › La chambre à air est cousue directement sur la carcasse par environ 400 points de couture
- › Technologie Made in Germany
- › Respect à 100 % des normes de contrôle qualité

Avantages

- › Légèreté: Poids inférieur à un pneu pliable
- › Rapide: Vitesse élevée grâce à une faible résistance au roulement
- › Adaptabilité: Peut supporter une pression élevée
- › Sûr: En cas de crevaison en roulant, le pneu ne déjante pas: parfait pour la compétition. Plébiscité par les coureurs professionnels.

PASSIONE E SUCCESSO ASSIEME RAGGIUNGERE GLI OBIETTIVI CON CONTINENTAL!

L'alta prestazione richiede impegno totale sia da parte del corridore che dal suo equipaggiamento. Per questo i migliori corridori nel mondo credono in Continental anche quest'anno. Che sia il Tour de France oppure i campionati del mondo dell'Ironman quest'anno i migliori atleti al mondo si affidano agli pneumatici da bicicletta Continental. Siamo orgogliosi di supportarli fornendo loro le migliori performance umanamente possibili attraverso i nostri pneumatici, assecondando così i loro obiettivi atletici.

QUAND LA PASSION ET LE SUCCÈS SE RENCONTRENT.

Une performance hors norme exige un engagement total du coureur et de son équipement. C'est la raison pour laquelle les meilleurs cyclistes au monde font confiance à Continental cette année encore. Que ce soit pour le Tour de France ou pour le Championnat du Monde d'Ironman, les meilleurs athlètes roulent en Continental. Nous sommes fiers de les accompagner dans leur quête de la performance et de les aider à atteindre leurs objectifs.



Il nostro pneumatico Tubeless Ready [TR] può essere usato con camera d'aria o liquido sigillante. Pneumatico e cerchio sono disegnati in modo che quando sono usati assieme si sigillano facilmente. Per motivi di sicurezza usiamo solo ruote progettate per essere Tubeless Ready. Gli pneumatici TR hanno un ulteriore design alleggerito. I loro fianchi sono meno permeabili all'aria e sono sigillati con uno speciale sigillante, per esempio il Conti RevoSealant.



HardShell. La resistenza alle forature e la durata sono i punti di forza di Hardshell-Protection. Uno strato PolyX-Breaker, ideale contro le forature, garantisce grande affidabilità. Il PolyX-Breaker si interpone tra battistrada e carcassa; è più ampio nella parte centrale e sotto le spalle. La carcassa è a tre strati, ognuno da 60 TPI, copre tutto lo pneumatico e lo rende intaccabile dai detriti urbani. La parte esterna della spalla è rinforzata con DuraSkin per proteggere al meglio la carcassa. I pneumatici Hardshell, prodotti esclusivamente in Germania, sono un punto di riferimento per la protezione dalle forature.



DuraSkin®. Gli pneumatici dotati di protezione delle pareti DuraSkin® devono poter affrontare qualsiasi situazione. Vengono utilizzati in condizioni estreme. Sulle biciclette dei corrieri gli pneumatici strisciano sui bordi dei marciapiedi, sulle biciclette da viaggio attraversano continenti senza usurarsi, mentre nelle gare ciclistiche devono superare le prove più ardue, come ad esempio quelle della Parigi-Roubaix. Il tessuto di poliammide di alta qualità protegge efficacemente il fianco dello pneumatico e lo rende idoneo a qualsiasi situazione estrema. Questi pneumatici sono contraddistinti da tutti gli altri dal fianco di colore marrone.



La gerarchia della qualità

Premium

- > i nostri pneumatici d'eccellenza, prodotti per le migliori performance
- > le ultime tecnologie sviluppate assieme ai migliori atleti al mondo
- > fatti a mano da specialisti esperti presso Korbach, Germania
- > i migliori materiali per la qualità più alta e caratteristiche eccezionali

Performance

- > pneumatici per la prestazione per corridori ambiziosi
- > materiali validi e manifattura precisa garantiscono qualità eccezionali

Sport

- > qualità eccellente per l'utilizzo di livello sportivo



La competenza dallo sport motociclistico, adattata specificamente alla bicicletta da competizione per assecondare i requisiti specifici della ruota anteriore e della posteriore. L'anteriore: agile e reattiva. Lo pneumatico più stretto assicura una riduzione della resistenza all'aria e migliora le caratteristiche di sterzata. La posteriore: confortevole e ammortizzante. Con la sua superficie di contatto al suolo leggermente più ampia lo pneumatico assicura una migliore trazione. La scorrevolezza viene migliorata grazie alla composizione ottimizzata della mescola, finalizzata alla resistenza al rotolamento. Il risultato è un sistema ruota anteriore e posteriore all'avanguardia, dove gli pneumatici sono stati attentamente accoppiati l'uno con l'altro.



Les pneus Tubeless Ready peuvent être utilisés au choix avec ou sans chambre à air. Pour être utilisé sans chambre à air, le pneu doit être étanchéifié avec un liquide préventif. Le talon révolutionnaire Tubeless Ready permet un montage simple du pneu sur la jante. Tous les pneus VTT Continental des gammes ProTction et Performance sont Tubeless Ready. Pour un résultat d'étanchéité parfaite, nous recommandons l'utilisation du préventif Continental RevoSealant.



Una speciale composizione di gomma mescola che utilizziamo per la nostra gamma di pneumatici Performance. Trazione e alta durata chilometrica sono le qualità delle coperture costruite con questa mescola.



Una tecnologia antiforatura strutturata con fibre di nylon protettive. È simile al Kevlar ma con una bassa resistenza al rotolamento e con un peso ridotto.



Il peso contenuto e la massima accelerazione contraddistinguono questa tecnologia. Gli specialisti delle cronometro e i pistard beneficeranno allo stesso modo delle sue caratteristiche di scorrevolezza di prima classe.

PASSIONE E TRADIZIONE

Il ciclismo su strada è la tua passione e con ogni uscita in bici sei parte della storia di questo sport, sia che tu stia gareggiando, allenandoti intensamente o semplicemente pedalando dopo il lavoro. Come da tradizione, produciamo i nostri prodotti a Korbach con tecnologia tedesca. Abbiamo avuto molte storie di successo che testimoniano questo, ad esempio il pneumatico Grand Prix 4000 S II.

PASSION ET TRADITION. Le cyclisme sur route est votre passion. Vous la vivez intensément en compétition, à l'entraînement et même en simplement pédalant après votre travail. Par tradition nous fabriquons nos produits à Korbach, avec une technologie allemande. Notre parcours est jalonné d'une multitude succès dont le pneu Grand Prix 4000 S II en est la parfaite illustration.



Notre nouvelle protection anti-crevaisson NyTech a été développée sur la base du SafetySystem Breaker éprouvé de Continental. Ses fibres en nylon le rendent aussi résistant aux crevaissons et aux coupures que le kevlar renforcé en fibres haute résistance, mais offre moins de résistance au roulement et un poids réduit. La NyTech Breker® se trouve entre le SafetySystem Breaker et le PolyX Breaker® comme une enveloppe de protection anti-crevaisson plus efficace dans le domaine des performances.



Avec TirePositioning® System, on atteint les dernières limites de ce qui est techniquement possible aujourd'hui. Les motards le savent depuis longtemps: les qualités attendues du pneu avant son différentes de celles demandées au pneu arrière. Le pneu avant plus étroit diminue la résistance au vent et procure une plus grande maniabilité dans les virages. Un mélange pour bande de roulement à adhérence optimisée procure une meilleure adhérence, en particulier dans les virages sur route mouillée. Le pneu arrière plus large possède, grâce à une surface de contact plus grande, une meilleure traction et offre en même temps plus de confort. Grâce à un mélange qui diminue la résistance au roulement et à une surface de contact plus grande à l'arrière, l'abrasion se voit diminuée. Le résultat est notre système novateur pneu avant/pneu arrière pour la compétition: que l'on retrouve sur le kit GP Attack/Force. Nouveau: la technologie TPS également proposée en boyaux avec le Set Attack/Force Comp.

- Premium Technology
- Performance Technology



Cette technologie se caractérise par un poids ultra léger et une réponse maximale à l'accélération. Particulièrement utilisée pour le contre-la-montre et les spécialistes de la piste.



Prêt pour rouler dans les pires conditions. Les pneus équipés de la protection DuraSkin sur les flancs sont prêts pour avoir la vie dure. Ils peuvent être utilisés dans les conditions les plus extrêmes. Les pneus des vélos de course frottent sur les bords de trottoirs, durant les randonnées ils sillonnent les continents sans s'user, pendant des courses ils doivent être d'une solidité à toute épreuve, comme lors du Paris-Roubaix. Le tissage en polyamide de très haute qualité protège efficacement les flancs du pneu et prémunit le pneu contre tous les aléas. Ces pneus se distinguent du tout-venant par leurs flancs marron.



Nos gammes de pneus Premium

Premium

- > nos meilleurs pneus pour des performances maximales
- > les toutes dernières innovations technologiques, développées avec les meilleurs athlètes au monde
- > fabriqué à la main par nos experts à Korbach (Allemagne)
- > les meilleurs matériaux pour une qualité optimale et des propriétés exceptionnelles

Performance

- > des pneus performants pour des coureurs ambitieux
- > des matériaux robustes et un travail humain de précision garantissant une qualité remarquable

Sport

- > une excellente qualité pour un usage sportif



A Base de composés de silice activée. Cette technologie a été initialement conçue pour la performance, mais après un développement intensif de notre service R&D de Korbach, un nouveau composé plus évolué avec une adhérence exceptionnelle et des propriétés exceptionnelles pour le cross-country a été développé. Ce nouveau mélange de gomme, qui porte le nom explicatif "PureGrip" [adhérence parfaite], est classé juste derrière notre fameuse BlackChili Compound et est utilisé sur nos produits de haute performance à la fois pour la route et pour le VTT. Tout en offrant une parfaite adhérence, il est aussi résistant et extrêmement durand - deux caractéristiques des pneus Continental, qui sont exclusivement fabriqués dans l'usine de Hefei [Asie]



HardShell. La protection contre les crevaissons et le kilométrage sont la force de Hardshell-Protection. Un PolyX Breaker plus large, le spécialiste contre les crevaissons, sous la bande de roulement et les bords offrent une grande fiabilité. Les trois couches - chaque couche avec 60 TPI - la carcasse recouvre le pneu entier et en fait un véritable barrage contre les débris urbains. Les parois latérales extérieures du pneu sont renforcées avec le tissu DuraSkin, offrant encore plus de fiabilité du fait que la carcasse est tellement bien protégée. Les pneus Hardshell est vraiment résistant aux coupures. C'est un pneu de course fabriqué exclusivement en Allemagne.

Grand Prix Attack & Force III



Più veloci verso la meta

L'accoppiata di pneumatici Grand Prix Attack & Grand Prix Force sfoggia tutta la sua essenza racer quando inizia la caccia ai secondi. Si tratta di pneumatici veloci, che guadagnano punti con tanta aerodinamica e con un peso ridotto. Ogni bicicletta da gara sarà pronta per il prossimo scatto.

Plus vite arrivé

Le Set Grand Prix Attack & Force est une véritable paire de pneus compétition qui vous permettra de gagner de précieuses secondes en course. Le Grand Prix Attack 22 mm profilé pour l'avant facilite la prise d'angle et apporte plus d'agilité. Le résistant Grand Prix Force 24 mm à l'arrière offre plus de traction et augmente la performance. Ces pneus sont vos alliés pour la gagne.

Grand Prix 4000 S II



All-rounder nel ProTour

Lo pneumatico Grand Prix 4000 S II è la combinazione perfetta tra comfort, protezione dalle forature e scorrevolezza. È un equilibrato all-rounder, che garantisce piacere di guida su qualsiasi tipo di terreno: è a proprio agio sia sull'acciottolato della Parigi-Roubaix sia sulla strada di montagna del Mont Ventoux. È uno pneumatico perfetto per lunghi tour, ma anche per qualsiasi tipo di competizione.

Le pneu polyvalent du ProTour

Le Grand Prix 4000 S II est devenu le pneu de référence sur le marché car il allie performance, adhérence et protection anti-crevaison exceptionnelles ainsi qu'une très grande longévité. Le GP 4000 S II vous emmènera aussi bien sur les pavés de Roubaix que sur la route sinueuse du Mont Ventoux. C'est le pneu parfait aussi bien pour les grandes randonnées que pour la compétition.

Jan Frodeno
Winner Ironman Austria 2017



Sebastian Kienle
Ironman European Champion 2017

Grand Prix 4-Season



Pronto per ogni stagione

L'elevata protezione dalle forature e la lunga durata caratterizzano il Grand Prix 4-Season. Oltre che per durezza questo pneumatico si impone per un'ottima aderenza. Che si trovi in una competizione piuttosto che in un tour, chi lo usa beneficia della grande resistenza del tessuto DuraSkin della carcassa, un compagno affidabile per il ciclista assiduo.

Équipé pour toutes les saisons

Le Grand Prix 4-Season étonne par sa résistance aux contraintes extrêmes et ses performances kilométriques élevées. Il offre également une excellente adhérence sur le mouillé et en conditions hivernales à basse température. Sa double protection Vectran™ et son renfort de carcasse DuraSkin® vous met à l'abri des crevaisons et coupures. Un pneu excellent pour les grandes randos comme pour la compétition et pas uniquement en hiver!

Grand Prix Supersonic



Lo pneumatico da competizione con carattere purista

Peso superlight, massima accelerazione: questi i punti chiave del leggero Grand Prix Supersonic. I cronoman e i pistard ne apprezzeranno le grandi doti di rotolamento. La sua costruzione è essenziale, per questo si è rinunciato alla protezione dalle forature. È uno pneumatico senza compromessi, destinato esclusivamente alle competizioni e con un chilometraggio limitato.

Le pneu de compétition puriste

Le Grand Prix Supersonic est un pneu super léger qui permet de lancer des accélérations maximales. Les spécialistes de la route et de la piste profitent de son rendement ultra performant. Ce pneu de compétition puriste a été allégé au maximum c'est pourquoi il n'a pas de protection anti-crevaison. Un pneu sans compromis. Un pneu de course pur avec un kilométrage réduit.

model/code	etrt	dimension	color/sidewall	technology	weight g	bar	max. bar	price
Grand Prix Attack & Force III								
0101440	22/24-622	700 x 23/25 C	black/black Skin foldable	Vectran Breaker	370	7,5	8,5	114,90 €
Grand Prix Attack								
0101303	22-622	700 x 22 C	black/black Skin foldable	Vectran Breaker	175	7,5	8,5	69,90 €
Grand Prix Force								
0101304	24-622	700 x 24 C	black/black Skin foldable	Vectran Breaker	195	7,5	8,5	69,90 €
Grand Prix 4000 S II								
0100935	23-571	650 x 23 C	black/black Skin foldable	Vectran Breaker	205	7,5	8,5	59,90 €
0100936	20-622	700 x 20 C	black/black Skin foldable	Vectran Breaker	185	9,0	11,0	59,90 €
0100937	23-622	700 x 23 C	black/black Skin foldable	Vectran Breaker	205	7,5	8,5	59,90 €
0100945	25-622	700 x 25 C	black/black Skin foldable	Vectran Breaker	225	6,5	8,5	59,90 €
0100947	28-622	700 x 28 C	black/black Skin foldable	Vectran Breaker	260	6,5	8,0	59,90 €
Grand Prix 4-Season								
0100173	23-622	700 x 23 C	black/DuraSkin foldable	Double Vectran Breaker	230	7,5	8,5	62,90 €
0100175	25-622	700 x 25 C	black/DuraSkin foldable	Double Vectran Breaker	240	6,5	8,5	62,90 €
0101105	28-622	700 x 28 C	black/DuraSkin foldable	Double Vectran Breaker	280	6,5	8,0	62,90 €
0101095	28-622	701 x 32 C	black/DuraSkin foldable	Double Vectran Breaker	320	6,5	8,0	62,90 €
Grand Prix Supersonic								
0101080	23-622	700 x 23 C	black/black Skin foldable	Supersonic	150	8,0	10,0	54,90 €

Grand Prix TT



Specialista nella lotta contro il tempo

Trasforma ogni bici da cronometro e da triathlon in una macchina da guerra, grazie al suo battistrada semislick ultraveloce. Essenziale in tutte le situazioni in cui anche un secondo può fare la differenza e ogni pedalata deve trasmettere tutta la forza impressa. Ogni cronoman guadagnerà punti grazie al suo peso ridotto e a un'elevata resistenza alle forature. È uno pneumatico da gara, con un chilometraggio limitato.

Le spécialiste de la course contre la montre

Le Grand Prix TT a été purement conçu pour le contre la montre. Le profil semi-slick rapide au centre permet de gagner des secondes et les épaules légèrement rugueuses assurent une parfaite sécurité en courbe. Particulièrement léger et très résistant aux crevaisons grâce au Vectran™ Breaker, ce spécialiste transforme n'importe quel vélo de route ou de triathlon en bête de course. Un pneu de course pur avec un kilométrage réduit.

Grand Prix



All-rounder confrotevole

Grand Prix è un classico all-rounder con un battistrada dal design moderno. È destinato alle biciclette da passeggio e da città. Offre una combinazione perfetta tra protezione dalle forature, comfort e scorrevolezza. Caratterizzato da una durata molto elevata, rende ogni tour un piacere puro. Uno strumento polivalente, con tante qualità.

Polyvalence et confort

Le Grand Prix est un classique synonyme de qualité et de performance. Il apporte une symbiose incontestable entre protection anti-crevaison, résistance à l'usure, performance et adhérence. Le profil moderne et le témoin d'usure complètent ses atouts. Un pneu très qualitatif qui apporte beaucoup de plaisir en randonnée.

Grand Sport Race



All-rounder nel segmento Performance

Il pneumatico Grand Sport Race ti porta al massimo rendimento. La combinazione perfetta di elevata protezione dalle forature, alto comfort e scorrevolezza lo rendono ideale per le competizioni e i tour. Ulteriori punti a favore sono il massimo grip in curva e la lunga durata. È un all-rounder e pronto anche per qualsiasi sfida, anche la più impegnativa.

Le modèle polyvalent du segment performance

Le Grand Sport Race pousse à la performance. C'est un pneu complet et équilibré avec une protection anticrevasion et suffisamment de PureGrip Compound sur la surface de roulement qui lui permettent d'avaler sans effort les nombreux kilomètres de courses et d'entraînement. Il offre une adhérence maximale en courbes et un roulement confortable: ce multi-talents est prêt à relever tous les défis, quels qu'ils soient.

model/code	etrto	dimension	color/sidewall	technology	weight g	bar	max. bar	price
Grand Prix TT								
0100487	23-622	700 x 23 C	black/black Skin foldable	Vectran Breaker	180	7,5	8,5	69,90 €
Grand Prix								
0100506	23-622	700 x 23 C	black/black Skin foldable	PolyX Breaker	225	7,5	8,5	43,90 €
0100637	25-622	700 x 25 C	black/black Skin foldable	PolyX Breaker	245	7,5	8,5	43,90 €
0101109	28-622	700 x 28 C	black/black Skin foldable	PolyX Breaker	275	6,5	8,0	43,90 €
Grand Sport Race								
0150001	23-622	700 x 23 C	black-black Skin foldable	NyTech Breaker	230	7,5	8,5	36,90 €
0150027	25-622	700 x 25 C	black-black Skin foldable	NyTech Breaker	270	6,5	8,5	36,90 €
0150118	28-622	700 x 28 C	black-black Skin foldable	NyTech Breaker	330	5,5	8,0	36,90 €

Ultra Sport II



Per entrare in gioco

Ultra Sport II è lo pneumatico moderno per i tour e le competizioni che spicca per l'eccezionale rapporto prezzo/prestazioni. Le numerose taglie disponibili rappresentano il tocco finale per la sua grande versatilità di utilizzo. Ulteriori punti a favore sono il buon grip, la mescola del battistrada a base di silice e la durata molto elevata.

L'entrée en piste

L'Ultra Sport II est un pneu moderne pour randonnées et compétition qui se distingue par un excellent rapport qualité/prix. Les nombreuses tailles disponibles représentent la touche finale de la coordination d'utilisation. Ce pneu marque des points avec un excellent grip, le mélange de bande de roulement à base de silice et une formidable performance de roulement.

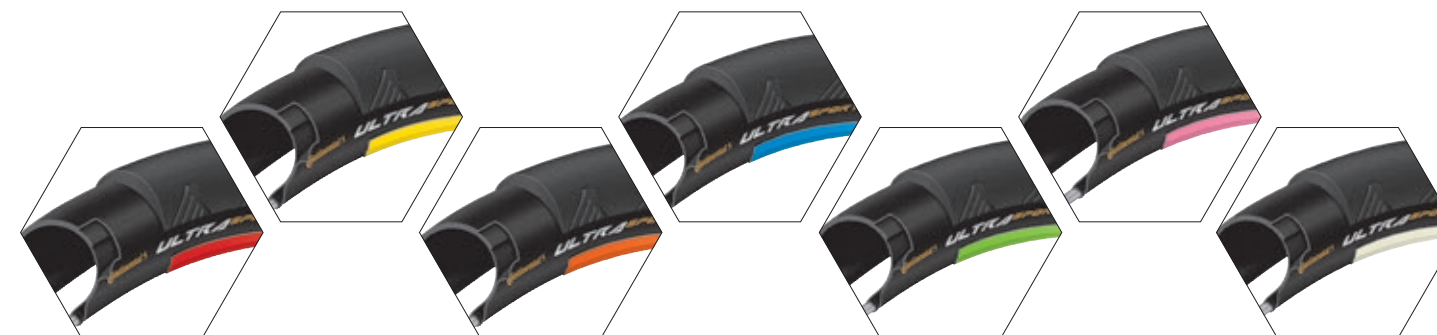

model/code	etrto	dimension	color/sidewall	technology	weight g	bar	max. bar	price
Ultra Sport II								
0150006	23-622	700 x 23 C	black/black Skin	Performance	310	7,5	8,5	20,90 €
0150003	23-622	700 x 23 C	black/black Skin foldable	Performance	240	7,5	8,5	26,90 €
0150009	25-622	700 x 25 C	black/black Skin	Performance	340	6,5	8,5	20,90 €
0150011	25-622	700 x 25 C	black/black Skin foldable	Performance	280	6,5	8,5	26,90 €
0150012	28-622	700 x 28 C	black/black Skin	Performance	410	5,5	8,0	20,90 €
0150014	28-622	700 x 28 C	black/black Skin foldable	Performance	340	5,5	8,0	26,90 €
Ultra Sport II coloured								
0150126	23-622	700 x 23 C	black/red foldable skin	Performance	250	7,5	8,5	26,90 €
0150128	23-622	700 x 23 C	black/orange foldable skin	Performance	250	7,5	8,5	26,90 €
0150129	23-622	700 x 23 C	black/blue foldable skin	Performance	250	7,5	8,5	26,90 €
0150130	23-622	700 x 23 C	black/green foldable skin	Performance	250	7,5	8,5	26,90 €
0150166	25-622	700 x 25 C	black/red foldable skin	Performance	290	6,5	8,5	26,90 €
0150170	25-622	700 x 25 C	black/orange foldable skin	Performance	290	6,5	8,5	26,90 €
0150173	25-622	700 x 25 C	black/blue foldable skin	Performance	290	6,5	8,5	26,90 €
0150174	25-622	700 x 25 C	black/green foldable skin	Performance	290	6,5	8,5	26,90 €
0150169	25-622	700 x 25 C	black/yellow foldable skin	Performance	290	6,5	8,5	26,90 €
0150177	25-622	700 x 25 C	black/pink foldable skin	Performance	290	6,5	8,5	26,90 €



Gatorskin

PolyX Breaker® **DuraSkin®**



Addio forature, ogni giorno

La particolare mescola resistente al taglio e la fibra PolyX Breaker garantiscono al Gatorskin una resistenza alla foratura molto elevata e un'aderenza eccellente. Il profilo del battistrada a forma di rettile dà il massimo per affrontare moltissimi chilometri. È uno pneumatico all-rounder, che colpisce per qualità e trasforma ogni curva in un momento di piacere. L'estrema durezza lo rende un valido alleato nelle uscite quotidiane.

Résistant à la perforation tous les jours

Le mélange de matériaux résistant aux coupures du Gatorskin offre une résistance à la ponction très élevée et beaucoup de plaisir. Ce tout-terrain impressionne par sa haute qualité qui fait de chaque voyage un réel plaisir lors de tournées. La marge de sécurité rend le pneu un compagnon quotidien très populaire.



Gator Hardshell

HARD SHELL PROTECTION



Il rettile corazzato

Uno pneumatico che impressiona, di costruzione robusta, di lunga durata, dà al ciclista urbano qualcosa in più e fa lavorare i commutatori in sicurezza. La sua affidabilità lo rende perfetto per l'uso touring su lunghe distanze. Questo grazie alla grande resistenza all'usura del suo battistrada ottimizzato e alla larga fettuccia antiforatura HardShell. Dopo chilometri e chilometri non mostrerà segni di fatica.

Le compagnon fiable

Le Gator Hardshell est un pneu impressionnant avec sa construction robuste et durable. En raison de sa fiabilité, c'est le préféré pour une utilisation sur les balades guidées et prolongées. Le produit résiste à un kilométrage extrêmement élevé également avec sa largeur spéciale. La doublure de protection contre les crevaisons offre un avantage supplémentaire. Ces pneus ne présentent aucun signe de fatigue même après de nombreux kilomètres.

model/code	etrto	dimension	color/sidewall	technology	weight g	bar	max. bar	price
Gatorskin								
0118538	23-622	700 x 23C	black/DuraSkin foldable	Race Quality	220	7,5	8,5	49,90 €
0100084	25-622	700 x 25C	black/DuraSkin foldable	Race Quality	240	6,5	8,5	49,90 €
0100641	28-622	700 x 28C	black/DuraSkin foldable	Race Quality	300	5,5	8,0	49,90 €
0100642	32-622	700 x 32C	black/DuraSkin foldable	Race Quality	350	6,0	7,0	49,90 €
Gator Hardshell								
0100311	23-622	700 x 23C	black/DuraSkin foldable Hardshell	Race Quality	250	7,5	8,5	62,90 €
0100313	25-622	700 x 25C	black/DuraSkin foldable Hardshell	Race Quality	270	6,5	8,5	62,90 €
0100639	28-622	700 x 28C	black/DuraSkin foldable Hardshell	Race Quality	375	5,5	8,0	62,90 €
0100640	32-622	700 x 32C	black/DuraSkin foldable Hardshell	Race Quality	375	6,0	7,0	62,90 €

GP Attack & Force Tubular Comp



Il set aerodinamico sviluppato per i professionisti

Dove contano aerodinamicità e leggerezza entra in gioco il Set Attack Comp & Force Comp. Sono tubolari veloci, leggeri e agili, sviluppati appositamente per l'utilizzo nelle competizioni ed all'altezza di aspettative elevate. Guadagnano punti grazie alla ridotta resistenza al rotolamento e offrono anche un buon comfort. Resistono alle forature grazie al Vectran™ e offrono massima reattività con la mescola BlackChili.

Le premier choix des coureurs

Le Set Attack Comp & Force Comp entre en scène partout où l'aérodynamisme et le poids ont un rôle à jouer. Cette paire de boyaux rapides, légers et agiles a été développée spécialement pour la compétition et répond aux plus hautes exigences. Le Set Attack Comp & Force Comp offre une très faible résistance au roulement tout en apportant un maximum de confort. Une paire de boyaux de catégorie haute performance.



Competition



All-rounder nella corsa professionistica

Competition è un all-rounder di utilizzo professionale all'altezza del livello World Tour. È un versatile tuttodfare, veloce ed agile, che emerge al termine delle maggiori competizioni al mondo grazie al carattere sempre combattivo. Spicca per la valida mescola sviluppata specificamente da Continental e per l'inserito di protezione dalle forature.

Le modèle polyvalent du monde des pros

Le Competition est un multi-talents qui répond à toute les exigences des ProTour et autres compétitions. Ce boyau s'adapte à toutes les conditions de route et apporte agilité et vitesse. Il fait preuve d'un caractère des plus combattifs. Le mélange de gomme performant développé par Continental combiné à une protection anti-crevaison ultra efficace lui fait prendre le rôle d'un avant-gardiste.



GP 4000 S II Tubular



Un all-rounder per i tour

Struttura senza cuciture per il Grand Prix 4000 S II, che si distingue soprattutto per la scorrevolezza unita all'aderenza in curva. È un all-rounder ideale per i lunghi tour, dove sfoggia le qualità della sua mescola antistrucchiolevole. Il particolare design della carcassa garantisce un perfetto alloggiamento sul cerchio.

Le polyvalent pour les randonnées

Le Grand Prix 4000 S II Tubular est un boyau sans couture qui se distingue avant tout par sa vitesse. Il est parfaitement adapté aux sorties prolongées où il peut jouer les atouts de son mélange de gomme ultra performant. Ce boyau offre une adhérence maximale et une maniabilité acérée en courbes. La construction spéciale de sa carcasse assure une parfaite assise sur la jante.



Sprinter



A caccia di vittorie

Lo Sprinter è caratterizzato da eccezionali proprietà di rotolamento grazie alla carcassa morbida. Offre il massimo nelle gare a circuito o nel triathlon. È la risposta giusta per chi chiede massima accelerazione e a questo aggiunge un peso ridotto e una manovrabilità equilibrata, grazie al suo profilo perfettamente slick.

La chasse aux points

Le Sprinter se distingue par ses excellentes propriétés de roulement grâce à sa carcasse souple. Il joue ses atouts surtout dans le domaine des critères. On peut se fier à ce boyau quand il est question d'accélération maximale. Ce boyau de compétition se distingue par son faible poids et sa conduite équilibrée.



Sprinter Gatorskin



Un classico per le grandi Classiche

A suo agio sulle strade del Giro delle Fiandre, della Parigi-Roubaix o della Milano-Sanremo. È uno pneumatico che si caratterizza per durata, per resistenza anche su fondi dissestati e per l'elevata protezione dalle forature. Incamera grandi quantità d'aria, ad ulteriore garanzia di sicurezza, scorrevolezza e comfort, anche negli attraversamenti veloci sul pavé.

Le chasseur classique passionné

Le Sprinter Gatorskin est chez lui sur les routes de Flandre, de Roubaix ou de San Remo. Ce boyau développé spécialement pour les courses classiques sait convaincre par sa grande résistance aux crevaisons et sa longévité kilométrique. Son volume important assure une sécurité supplémentaire et un roulement encore meilleur. Tout cela offre un grand confort sur la route même à pleine vitesse sur les pavés.



Ag2r La Mondiale Pro Cycling Team

Safety System

Resistente alle forature e ai tagli, ma allo stesso tempo leggero e flessibile, lo pneumatico si adatta meglio al fondo stradale. Garantisce caratteristiche di guida particolarmente confortevoli.

Safety System

Résistant aux perforations et aux coupures tout en restant léger et souple, le pneu s'adapte mieux au terrain pour une tenue de route des plus agréables.

model/code	etrto	dimension	color/sidewall	technology	weight g	bar	max. bar	price
Set GP Attack & Force Tubular								
0100748		28" x 22/24 mm	black/black Skin	Vectran Breaker	500	8,0	12,0	219,90 €
GP Attack Tubular								
0196231		28" x 22 mm	black/black Skin	Vectran Breaker	240	8,0	12,0	114,90 €
GP Force Tubular								
0196232		28" x 24 mm	black/black Skin	Vectran Breaker	260	8,0	12,0	114,90 €
Competition								
0196141		26" x 22 mm	black/black Skin	Vectran Breaker	250	8,0	12,0	114,90 €
0196140		28" x 19 mm	black/black Skin	Vectran Breaker	230	10,0	12,0	114,90 €
0196138		28" x 22 mm	black/black Skin	Vectran Breaker	260	8,0	12,0	114,90 €
0196189		28" x 25 mm	black/black Skin	Vectran Breaker	280	8,0	12,0	114,90 €
GP 4000 S II Tubular								
0196241		28" x 22 mm	black/black Skin	Vectran Breaker	270	8,0	12,0	119,90 €
Sprinter								
0196135		28" x 22 mm	black/black Skin	SafetySystem Breaker	275	8,0	12,0	65,90 €
0196244		28" x 25 mm	black/black Skin	SafetySystem Breaker	295	8,0	12,0	65,90 €
Sprinter Gatorskin								
0196136		28" x 22 mm	black/black Skin	SafetySystem Breaker	280	8,0	12,0	70,90 €
0196187		28" x 25 mm	black/black Skin	SafetySystem Breaker	300	8,0	12,0	70,90 €

Podium TT



Specialista nella lotta contro il tempo

Va a caccia di secondi grazie al suo battistrada ultraleggero con profilo semi-slick. Ideale per le gare a cronometro e allo stesso tempo molto resistente alle forature. Oltre ai cronoman è compagno fedele anche dei triatleti. Ottimizzato per le velocità, ma con chilometraggio limitato.

Le spécialiste du contre-la-montre

Son profil semi-slick ultra rapide fait du Podium TT le partenaire idéal lors de course contre la montre. Ce spécialiste est particulièrement léger tout en offrant une excellente résistance aux crevaisons. Un véritable boyau de compétition pour les spécialistes de la course contre la montre et les triathlètes.

Giro



Compagno di allenamento per principianti

Il tubolare Giro spicca per la durata elevata e per l'eccellente rapporto prezzo/prestazione/durata. Ottime le sue proprietà di rotolamento e per la robustezza garantita anche dopo molti chilometri di allenamento. Questo pneumatico è il compagno perfetto nell'allenamento e nei tour di chi vuole avvicinarsi in modo serio al ciclismo.

Le partenaire d'entraînement pour les débutants

Le Giro fait sensation grâce à sa grande capacité de kilométrage et son excellent rapport qualité-prix. Il se distingue par ses excellentes propriétés de roulage et sa robustesse et il est toujours prêt même après de nombreux kilomètres d'entraînement. Ce boyau est le compagnon idéal pour les débutants, pour l'entraînement et en randonnées.



model/code	etrto	dimension	color/sidewall	technology	weight g	bar	max. bar	price
Podium TT								
0196180		28" x 22 mm	black/black Skin	Vectran Breaker	225	11,0	12,0	119,90 €
0196243		28" x 25 mm	black/black Skin	Vectran Breaker	245	8,0	12,0	119,90 €
Giro								
0196017		28" x 22 mm	black/transparent Skin	Performance	300	8,0	10,0	34,90 €



 Patrick Seabase
 Freecycler

Race King CX

La giusta opzione per l'allenamento e i tour

Lo pneumatico Cyclocross Race è molto veloce, si presta ottimamente all'utilizzo su fondi compatti. Ideale nei percorsi tra boschi e campi, dove sfoggia un invidiabile rapporto tra ridotta resistenza al rotolamento e buon grip. Con questo tubolare le uscite mozzafiato sono garantite!

Le compagno pour l'entraînement et les randonnées

Le Cyclocross Race est très rapide et parfaitement adapté à l'utilisation sur les sols durs. C'est le compagnon idéal sur les sentiers de forêt et entre les champs. Il offre un parfait compromis entre accroche, confort et faible résistance au roulement. Ce pneu est un pur-sang pour les virées exigeantes en terrains libres.

Speed King CX

Un semi-slick con passione per la velocità

Lo pneumatico da competizione Cyclocross Speed è a proprio agio sui fondi compatti, asciutti o ghiacciati. È un alleato negli allenamenti dei ciclocrossisti grazie alla sua bassa resistenza al rotolamento e alla capacità di trasmettere la velocità impressa sui pedali. Questo grazie alla banda centrale con scolpitura microdiamantata, che tra l'altro garantisce una protezione extra dalle forature. La sezione da 32 mm è conforme alle normative delle gare Uci.

Le pneu semi-slick avec résistance aux crevaisons en prime

Son nom est tout un programme. Le Cyclocross Speed, adapté à la course, est à son aise sur les terrains durs, secs ou gelés. Les crossers profitent de sa faible résistance au roulement à l'entraînement ou pendant leurs virées et atteignent des vitesses élevées. Une des raisons à cela est sa surface de roulement médiane en forme de diamant qui assure en même temps une résistance supplémentaire aux crevaisons.

CycloXKing

All-rounder per tour e competizione

CycloXKing è uno pneumatico versatile, a suo agio su ogni terreno e in ogni condizione climatica. L'ampia banda centrale del battistrada presenta tasselli uniformi, che lo rendono scorrevole e scattante. Da parte loro, le due file esterne di tasselli più pronunciati assicurano maggiore grip in curva. I ciclocrossisti lo apprezzeranno sia per le gare che per i tour. La sezione da 32 mm è conforme alle normative delle gare Uci.

Le modèle polyvalent pour la randonnée et la compétition

Le CycloXKing est à l'aise sur tous les terrains. Il gagne des points avec son profil silencieux et rapide qu'il doit à ses crampons médians homogènes. Ses crampons extérieurs rehaussés assurent sa bonne tenue dans les virages. Ce pneu montre tout ce dont il est capable sur les conditions de terrain les plus variées. Les cyclocrossers sont ainsi parfaitement équipés aussi bien pour les randonnées que pour les compétitions.

model/code	etrto	dimension	color/sidewall	technology	weight g	bar	max. bar	price
Race King CX								
0150280	35-622	700 x 35 C	black/black Skin foldable	Sport	350	4,0	6,0	36,90 €
Speed King CX								
0150279	35-622	700 x 35 C	black/black Skin foldable	Sport	350	4,0	6,0	36,90 €
CycloXKing								
0150281	35-622	700 x 35 C	black/black Skin foldable	Sport	380	4,0	6,0	36,90 €

PASSIONE E FLOW

Praticare mountain biking senza limiti, assaporare il trail e lasciarsi dietro il trail con un sorriso splendente. Per la tua perfetta esperienza in mountain bike i nostri pneumatici vengono continuamente implementati. Per ottenere questo noi crediamo unicamente nei materiali e nelle tecnologie più affidabili. L'aderenza perfetta su ogni fondo è il nostro obiettivo. Sempre.

PASSION ET BALADE

Pédaler sans limites, savourer la route et se retourner pour voir le chemin parcouru avec un sourire radieux. Nous travaillons en permanence pour améliorer nos pneus et vous offrir une expérience cycliste en montagne exceptionnelle. Pour cela, nous ne faisons confiance qu'aux meilleurs matériaux et technologies. Notre objectif quotidien: garantir aux cyclistes une adhérence parfaite, sur tous types de routes.



TECNOLOGIE MOUNTAIN BIKE

Tutti i nuovi pneumatici MTB ProTecton Apex e ProTecton sono stati testati e approvati per un carico sul mozzo tra i 95 e i 105 kg (dimensione 2.2 pollici). Questo significa che soddisfano ampiamente i requisiti delle moderne e-MTB.

TECHNOLOGIES DE VVT

Tous les nouveaux modèles VTT ProTecton apex et ProTecton ont été testés et approuvés pour une charge extrême de 95 kg (pour 2,2 pneus) à 105 kg. Ainsi, ils ont répondu de manière satisfaisante aux nouvelles exigences des VTT électronique.

ProTecton^{Apex}

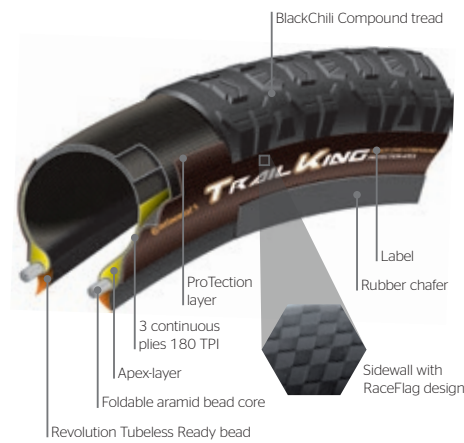

Pronto per nuove sfide. L'enduro è una disciplina che sta godendo di una popolarità sempre maggiore. Oltre alla discesa, la sfida tecnica che propone è alle partenze veloci e alle impegnative salite tecniche. Per questo è indispensabile avere una struttura resistente alle forature, una buona proprietà di rotolamento e un eccellente grip. La tela ProTecton è collaudata in questo senso: protegge in modo sicuro lo pneumatico da tagli e fori senza aumentare in modo eccessivo il peso. La stabilizzazione aggiuntiva delle pareti laterali Apex fa il resto, proteggendo lo pneumatico dalle forature, anche a basse pressioni di esercizio. Per gli amanti della leggerezza è inoltre disponibile la versione Tubeless Ready, ovvero senza camera d'aria, fornita assieme al liquido sigillante Conti RevoSealant. Accoppiata alla resistente mescola del battistrada in BlackChili Compound si ottiene l'accoppiamento ideale per arrampicarsi agevolmente in salita e per scendere in discesa senza il rischio di forare.

Équipé pour de nouveaux défis. Véritable défi technique, l'Enduro est une discipline à la popularité croissante qui consiste à se mesurer à des descentes rapides et vertigineuses ainsi qu'à d'incroyables ascensions. De telles conditions requièrent la combinaison d'une construction anti-crevaison, de bonnes qualités de roulement et d'une excellente adhérence. La couche éprouvée ProTecton garantit efficacement les pneus contre les coupures et les perforations sans trop les alourdir. Par ailleurs, faiblement gonflés, les pneus sont à l'abri de l'éclatement grâce au système supplémentaire de stabilisation des parois latérales Apex. De plus, le RevoSealant "Tubeless Ready" de Conti permet d'optimiser au mieux le poids. L'alliance avec la surface de roulement BlackChili Compound durable est des plus optimales pour une excellente ascension des pentes et des descentes sans risque de crevaison.

ProTecton

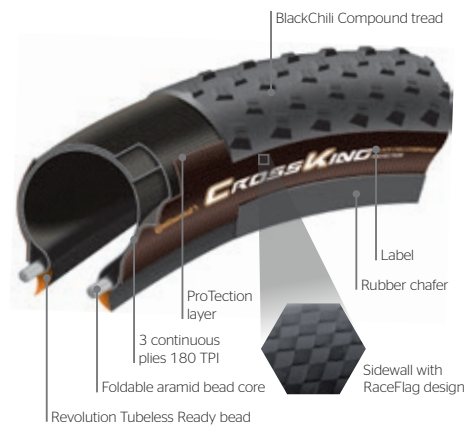

Per la strada più difficile. Le nuove carcasse Continental ProTecton sono state ulteriormente migliorate: la fettuccia anti-foratura è stata applicata in modo uniforme su tutto l'arco di circonferenza dello pneumatico, così da renderlo particolarmente resistente alle lesioni e alle perforazioni di corpi estranei. Rispetto ai già apprezzati predecessori in DuraSkin® le carcasse ProTecton pesano il 25 per cento in meno e offrono il 30 per cento di protezione in più dalle forature. Migliorate sono anche la resistenza al rotolamento e le capacità di assorbire i colpi, che completano le qualità assolute della tecnologia "made in Germany" di questi prodotti. Versatili e universali, le carcasse ProTecton convincono anche grazie alla mescola BlackChili Compound e al design accattivante dei fianchi. Il nuovo tallone Revolution permette di utilizzarle come coperture tubeless ready; in questo caso per ottenere la migliore efficienza è consigliato l'utilizzo del nuovo sigillante Continental RevoSealant.

La manière forte. Les nouvelles carcasses Continental ProTecton n'ont jamais eu aussi belle allure. La bande de protection supplémentaire contre la crevaison la rend particulièrement résistante et insensible aux lésions ou à la pénétration de corps étrangers. Bande de roulement et flancs sont protégés de la même manière. Elles sont pourtant plus légères de 25% et assurent une protection anti-crevaison supérieure de 30% par rapport à leurs prédécesseurs armés de DuraSkin®. Par ailleurs, elles améliorent une fois de plus la résistance au roulement et l'amortissement. La nouvelle technologie "made in Germany" leur permet même de résister aux "trails" les plus durs du monde. Et elles ont encore un atout en poche: d'usage universel, elles séduisent de surcroît par le BlackChili Compound et le design attrayant des flancs. Le nouveau talon Revolution Tubeless Ready facilite l'utilisation en pneu Tubeless Ready. Pour des résultats idéaux de colmatage et de mise en oeuvre, nous recommandons d'utiliser le nouveau produit d'étanchéité Continental RevoSealant.

Apex



Il fianco degli pneumatici da freeride e downhill deve sopportare carichi estremamente elevati. La stabilità è assicurata da uno strato in caucciù tra le tele della carcassa. L'Apex è posizionato al centro della struttura dello pneumatico, a rinforzo dei fianchi. In questo modo gli pneumatici non urtano il cerchio anche quando si transita sulle rocce acuminate o sui percorsi accidentati. Gli pneumatici rimangono dritti e stabili nel loro alloggiamento sul cerchio, anche affrontando le curve più impegnative, senza stallonare neanche quando soggetti a forti carichi laterali.

Les flancs des pneus Freeride et Downhill sont soumis à des contraintes particulièrement élevées. La stabilité est assurée par un profilé en caoutchouc entre les plis de la carcasse. L'Apex repose sur les tringles du pneu et en renforce les flancs. Le pneu ne s'écrase pas sur la jante en cas de passages difficiles sur terrains pierreux. Le pneu adhère mieux en courbes. Il ne se plie pas sous la charge transversale au-delà du flanc de la jante mais suit avec fermeté la direction dictée.

RaceSport



Leggero, veloce, sicuro. Concepite senza compromessi per l'impiego nelle gare di mountain bike, le carcasse RaceSport uniscono la leggerezza della loro costruzione a una protezione antiforatura superiore. Sono state sviluppate assieme ai biker professionisti, per creare il punto di riferimento perfetto per le coperture da competizione. Sono realizzate a mano in Germania e offrono il 30 per cento di protezione dalle forature in più rispetto alle coperture Supersonic. A fare la differenza è la struttura costruttiva: troviamo un tessuto di nylon particolarmente sottile e di alta qualità, accoppiato a un costoso rivestimento protettivo in gomma e a un tallone universale. Unite alla leggendaria mescola BlackChili Compound RaceSport formano il perfetto binomio per le competizioni di XC o di marathon di ultima generazione.

Léger, rapide, sûr. Conçues sans compromis pour être utilisées en compétition VTT: les carcasses RaceSport associent une grande légèreté de fabrication à un niveau maximal de résistance aux crevaisons. En coopération avec de grands noms du VTT professionnel, nous avons ainsi créé la base de départ idéale pour des pneus course. Faits main en Allemagne, elles assurent une protection anti-crevaison supérieure de 30% à celle des pneus Supersonic. C'est la structure qui fait la différence - un tissu nylon de haute qualité particulièrement fin avec un revêtement protecteur en caoutchouc très élaboré et un talon universel. Conjugué au mélange légendaire BlackChili, c'est la combinaison dernier cri pour les courses XC et le Marathon.

Performance

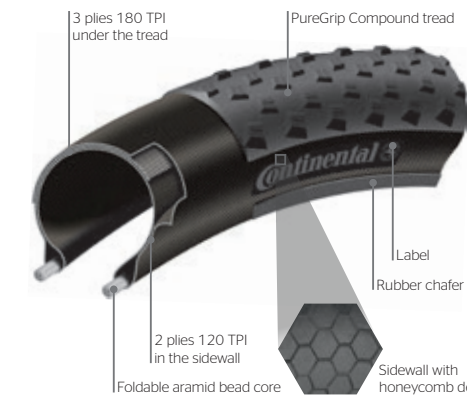

Qualità di fiducia. PureGrip è la tecnologia di mescola utilizzata esclusivamente sulle coperture destinate alle alte prestazioni. Il nome parla da solo e unisce un'aderenza superiore e grande durezza. Non lasciare mai nessun ciclista nei guai è stato uno dei principali obiettivi a cui si è puntato nel momento in cui questa nuova mescola è stata sviluppata e poi prodotta, presso il nuovo stabilimento Continental in Cina. La Performance è applicata su una robusta carcassa in nylon da 60 TPI (fili per pollice) in modo da consegnare una copertura affidabile, resistente e adatta a chiudere a tenuta lo pneumatico di tipo tubeless, senza camera d'aria, assieme al liquido sigillante Conti RevoSealant. Da parte loro talloni pieghevoli in morbida ma robusta aramide assicurano una tenuta salda sul cerchio. Gli pneumatici con mescola Performance sono qualitativamente allineati agli articoli similari prodotti dalla concorrenza asiatica, per questo offrono al bike dilettante ed ambizioso una conveniente alternativa siglata "Continental".

Une qualité fiable. PureGrip est une technologie mixte issue de la dernière gamme de qualité performance. Son nom des plus éloquents n'est pas sans évoquer accroche et longévité. Particulièrement solide et adhérent, le mélange de caoutchouc est l'allié idéal de tout cycliste, une caractéristique qui répond ainsi à l'un des objectifs principaux fixés pour le développement de ce produit de la nouvelle usine chinoise de Continental. Grâce à une robuste carcasse en nylon 60 TPI alliée à du caoutchouc haute qualité, cette technologie permet une emprise excellente et un colmatage tubeless des pneus à l'aide du RevoSealant "Tubeless Ready" de Conti. La tenue sur la jante est garantie par une tringle souple en aramide. Grâce à ces matériaux de pointe, ces pneus peuvent se mesurer à leurs concurrents asiatiques tout en représentant pour les ambitieux amateurs de vélo une alternative peu onéreuse signée Continental.

Der Baron 2.4 Projekt



B+Tyres

Gli pneumatici B+Tyres offrono un'esperienza di guida confortevole, ma non solo: la maggiore capacità di incamerare aria dovuta alla sezione incrementata consente di sorpassare facilmente gli ostacoli e migliorare nettamente la trazione su qualunque superficie, anche grazie a pressioni di esercizio più basse rispetto alle coperture con sezione tradizionale. Inoltre, nonostante le dimensioni "plus", il peso dei B+Tyres è relativamente contenuto e la carcassa ottimizzata riesce a migliorare ancor più l'aderenza al suolo.



Mountain King 2.4

More comfort,
more volume!



Cross King 2.4

Trail King 2.4



B+Tyres

Les pneus B+Tyres offrent une expérience de pilotage confortable. En raison de leur grand volume, ces pneus roulent facilement sur les obstacles, montrant plus de traction et avalant les sentiers au lieu de simplement le rouler. Le poids de ces pneus est relativement faible. Leurs carcasses optimisées permet une réduction de pression et donc une expérience de prise spécifiquement adaptée.

Der Kaiser 2.4



L'imperatore in abito da corsa

È lo pneumatico da competizione più gettonato sulle piste di Coppa del Mondo. Der Kaiser 2.4 spicca per la ridotta resistenza al rotolamento, per l'alta resistenza alle forature e per un feeling in curva immediato, anche grazie alla doppia fila di tasselli centrali piatti e ai tasselli sulle spalle uniformi. Der Kaiser 2.4 è lo pneumatico giusto per disegnare le linee più aggressive. Le qualità sono da competizione pura, per questo la resa chilometrica è contenuta.

Der Kaiser en tenue de course

Ce pneu de contest ne demande qu'à relever des défis et ce sur les parcours les plus durs de la coupe du monde. Der Kaiser Projekt brille par sa faible résistance au roulement, sa grande résistance à la torsion et aux coupures et offre une tenue en courbe progressive. C'est ce que garantissent ses crampons médians plats et ses crampons extérieurs en biseau. Le bon pneu pour des descentes agressives. Un pneu pur compétition avec un kilométrage réduit.

Der Baron 2.4



Giù il cappello per il padrone indiscusso nell'enduro

Questo pneumatico da competizione chiede di essere messo alla prova sui percorsi più tecnici della Coppa del Mondo. Il Der Baron 2.4 brilla per la bassa resistenza al rotolamento, per l'elevata resistenza alla foratura e per il feeling in curva ottimale. Il disegno sfalsato dei tasselli centrali e il profilo della carcassa dal design uniforme permettono di scegliere sempre le linee più aggressive. È una copertura da Coppa del Mondo costruita a mano in Germania.

Respect où est due: le maître incontesté en enduro

Ce pneu de course veut être poussé sur le plus difficile Cours de Coupe du Monde au monde. The Kaiser 2.4 Projekt brille avec une faible résistance au roulement, une forte résistance à la perforation et sensation de courbe directe. Les pattes centrales moins profondes et les des pattes extérieures uniformes l'assurent. Le bon pneu pour un agressif Choix de ligne. Les pneus "Handmade in Germany" World Cup avec Kilométrage réduit!

Andreu Lacondeguy



model/code	predecessor	etrto	dimension	color/sidewall	technology	weight g	bar	max. bar	price
Der Kaiser 2.4 Projekt									
0101567	0101114	60-584	27.5 x 2.4	black/black foldable	ProTecton Apex	950	2,5	3,5	70,90 €
0101569		60-622	29 x 2.4	black/black foldable	ProTecton Apex	1.000	2,5	3,5	70,90 €
Der Baron 2.4 Projekt									
0101572		60-584	27.5 x 2.4	black/black Skin foldable	ProTecton Apex	950	2,5	3,5	70,90 €
0101573		60-622	29 x 2.4	black/black Skin foldable	ProTecton Apex	1.000	2,5	3,5	70,90 €

Mud King



Il re del fango

Il nome parla chiaro: Mud King dà il massimo sui terreni fangosi e allentati. Anche in condizioni estreme questo pneumatico conserva ottime capacità di trazione, grip in frenata e direzionalità in curva. La sezione contenuta della carcassa evita l'accumulo di fango, così come i tasselli pronunciati ma radi ne facilitano l'espulsione. Mud King 1.8 è il numero uno nei cross country fangosi e anche in alcune downhill.

Chez lui dans la boue

Le Mud King convient particulièrement bien aux sols épais et boueux. En conditions difficiles, ce pneu convainc également par son excellente transmission de freinage et sa force motrice. Sa carcasse moins large laisse un espace suffisant entre le pneu et le cadre et ainsi, l'accumulation de boue ne constitue plus un problème. En cas de terrain humide, le spécialiste de la boue est un pneu de premier choix pour les hardtails ou les VTT de descente rapides.

Trail King



Prestazioni super su ogni pista

Grazie ai numerosi e piccoli tasselli il Trail King assicura una trazione ottimale su ogni percorso, anche il più impegnativo. È ideale sulle biciclette da all mountain e da enduro, con un'escursione della forcella a partire da 140 mm. La struttura della carcassa offre la necessaria protezione dalle forature. È uno pneumatico che assicura al biker un feeling costante a prescindere dal fondo e che si adatta alle varie condizioni di corsa.

Super performant sur tous les trails

Avec ses nombreux crampons, le Trail King garantit la meilleure traction possible quelle que soit la difficulté du trail. Ce pneu se distingue sur les VTT All Mountain et Enduro à débâtements à partir de 140 mm. Sa carcasse résistante le protège des crevaisons. Le rider peut compter sur ce pneu qui lui permet de s'adapter rapidement aux conditions et de conserver une vitesse à plein régime.

model/code	predecessor	etrto	dimension	color/sidewall	technology	weight g	bar	max. bar	price
Mud King 1.8 ProTecton									
0101084		47-584	27.5 x 1.8	black/black Skin foldable	ProTecton	550	3,0	4,5	59,90 €
0100918		47-622	29 x 1.8	black/black Skin foldable	ProTecton	580	3,0	4,5	59,90 €
Der Mud King 2.3									
0100414		57-559	26 x 2.3	black/black	Apex	1100	3,0	4,5	81,90 €
0101083		57-622	29 x 2.3	black/black	Apex	1160	3,0	4,5	81,90 €
Trail King 2.2 ProTecton									
0101468	0101117	55-584	27.5 x 2.2	black/black Skin foldable	ProTecton Apex	855	3,0	4,0	70,90 €
0101476	0101118	55-622	29 x 2.2	black/black Skin foldable	ProTecton Apex	920	3,0	4,0	70,90 €
Trail King 2.2 Performance									
0150293	050107	55-584	27.5 x 2.2	black/black Skin foldable	Performance	762	3,0	4,0	32,90 €
0150298		55-622	29 x 2.2	black/black Skin foldable	Performance	813	3,0	4,0	32,90 €
Trail King 2.4 ProTecton									
0101478	0100653	60-559	26 x 2.4	black/black foldable	ProTecton Apex	825	2,5	3,5	70,90 €
0101460	0100903	60-584	27.5 x 2.4	black/black foldable	ProTecton Apex	890	2,5	3,5	70,90 €
0101477	0100656	60-622	29 x 2.4	black/black foldable	ProTecton Apex	945	2,5	3,5	70,90 €
Trail King 2.4 Performance									
0150288	0150106	60-584	27.5 x 2.4	black/black Skin foldable	Performance	885	3,0	4,0	32,90 €
0150299	0150140	60-622	29 x 2.4	black/black Skin foldable	Performance	943	3,0	4,0	32,90 €
0150234		60-584	27.5 x 2.4	black/black Skin	Performance	890	3,0	4,0	25,90 €
Trail King 2.6 ProTecton									
0101382		65-584	27.5 x 2.6	black/black foldable	ProTecton Apex	930	2,0	3,	79,90 €

Mountain King



updated profile
re-engineered sidewall

Sicuro a spasso tra la natura

Il Mountain King dà il meglio di sé sulle biciclette da all mountain. La scolpita direzionale e antistrucchiolo lo rendono un ideale pneumatico anteriore, visto che i tasselli centrali mordono, mentre quelli laterali aderiscono ed offrono un buon grip su qualsiasi terreno. È il compagno perfetto per le uscite sportive.

Traverser les terrains en toute sécurité

Le Mountain King révèle ses qualités en All Mountain. Grâce à la géométrie ouverte et à bonne adhérence de son profil, c'est le pneu avant idéal. Le mordant de ses crampons médians et l'adhérence de ses crampons latéraux lui donne un très bon grip sur tous les terrains. Ce pneu est le compagnon idéal pour les virées sportives.

Cross King



updated profile
re-engineered sidewall

L'all-rounder

Il pneumatico X-King convince grazie alla sua versatilità. Lo scorrevole pneumatico per mountain bike si adatta a qualsiasi terreno, guadagna punti grazie alla perfetta tenuta in curva e al silenzioso rotolamento. Offre quindi un ottimo grip per la ridotta resistenza al rotolamento e lo speciale battistrada promuove l'autopulizia. Questo lo rende lo pneumatico di prima categoria per le competizioni e l'all-round.

Le touche-à-tout

Le X-King convainc par sa polyvalence. Ce pneu VTT léger s'adapte à tous les terrains. Ses atouts sont sa parfaite tenue dans les courbes et son roulement silencieux. De plus, il offre une très bonne adhérence pour une faible résistance au roulement et son profil spécial facilite l'auto-nettoyage. Cela fait de lui un pneu de compétition et tout terrain de première qualité.

Race King



updated profile
re-engineered sidewall

Un classico per gli agonisti

Il Race King è un classico tipo da competizione. È gettonatissimo nelle gare di cross-country o nelle marathon e si addice sia alle front che alle full suspended. Spicca per la bassa resistenza al rotolamento, ha una carcassa voluminosa e un'ottima capacità di smorzare i colpi. Il battistrada garantisce i requisiti più utili per il biker assiduo.

Le premier choix des coureurs

Le Race King est le type même du classique de compétition. Ce pneu est utilisé dans les courses de cross country ou les marathons et est également adapté aux hardtails et aux races fullys. Il sait convaincre par sa faible résistance au roulement, sa carcasse volumineuse et son excellent amortis. Son profil offre les meilleures conditions aux cyclistes assidus.

model/code	predecessor	etrto	dimension	color/sidewall	technology	weight g	bar	max. bar	price
Mountain King II 2.2									
0150246	0100851	55-584	27.5 x 2.2	black/black Skin	Sport	750	3,5	4,5	25,90 €
Mountain King II 2.3 ProTecton									
0101461	0100907		27.5 x 2.3	black/black Skin foldable	ProTecton	705	2,5	3,5	62,90 €
0101469	0100723		29 x 2.3	black/black Skin foldable	ProTecton	745	2,5	3,5	62,90 €
Mountain King III 2.3 Performance									
0150301		58-559	26 x 2.3	black/black Skin foldable	Performance	762	3,5	4,5	32,90 €
0150289	0150111	58-584	27.5 x 2.3	black/black Skin foldable	Performance	796	3,5	4,5	32,90 €
0150294	0150048	58-622	29 x 2.3	black/black Skin foldable	Performance	845	3,5	4,5	32,90 €
Mountain King 2.6									
0101583		65-584	27.5 x 2.6	black/black foldable	ProTecton	815	2,0	3,0	79,90 €
Cross-King 2.2 ProTecton									
0101483	0100524		26 x 2.2	black/black Skin foldable	ProTecton	570	3,0	4,0	62,90 €
0101465	0100910		27.5 x 2.2	black/black Skin foldable	ProTecton	600	3,0	4,0	62,90 €
0101471	0100532		29 x 2.2	black/black Skin foldable	ProTecton	640	3,0	4,0	62,90 €
Cross King II 2.2 Performance									
0150303	0150002	55-559	26 x 2.2	black/black Skin foldable	Performance	711	3,5	4,5	32,90 €
0150291		55-584	27.5 x 2.2	black/black Skin foldable	Performance	743	3,5	4,5	32,90 €
0150295	0150045	55-622	29 x 2.2	black/black Skin foldable	Performance	793	3,5	4,5	32,90 €
Cross King 2.2 RaceSport									
0101464	0100911		27.5 x 2.2	black/black Skin foldable	RaceSport	530	3,0	4,0	59,90 €
0101470	0100531		29 x 2.2	black/black Skin foldable	RaceSport	565	3,0	4,0	59,90 €
Cross King 2.3 RaceSport									
0101462	0100899		27.5 x 2.3	black/black Skin foldable	RaceSport	635	2,5	3,5	59,90 €
0101474	0100726		29 x 2.3	black/black Skin foldable	RaceSport	675	2,5	3,5	59,90 €
Cross King 2.3 ProTecton									
0101463	0100909		27.5 x 2.3	black/black Skin foldable	ProTecton	705	2,5	3,5	62,90 €
0101475	0100725		29 x 2.3	black/black Skin foldable	ProTecton	745	2,5	3,5	62,90 €
Cross King II 2.3 Performance									
0150302		58-559	26 x 2.3	black/black Skin foldable	Performance	749	3,5	4,5	32,90 €
0150290	0150110	58-584	27.5 x 2.3	black/black Skin foldable	Performance	782	3,5	4,5	32,90 €
0150297	0150042	58-622	29 x 2.3	black/black Skin foldable	Performance	831	3,5	4,5	32,90 €
Cross-King 2.6 ProTecton									
0101384		65-584	27.5 x 2.6	black/black foldable	ProTecton	815	2,0	3,0	79,90 €
Race King II 2.0									
0150309	0150109	50-584	26 x 2.3	black/black Skin foldable	Performance	615	3,5	4,5	32,90 €
0150307	0150035	50-622	27.5 x 2.3	black/black Skin foldable	Performance	655	3,5	4,5	32,90 €
0150160	0100271	50-622	29 x 2.3	black/black Skin foldable	Performance	680	3,5	4,5	25,90 €
Race King 2.2 RaceSport									
0101466	0100914		27.5 x 2.2	black/black Skin foldable	RaceSport	500	3,0	4,0	59,90 €
0101472	0100545		29 x 2.2	black/black Skin foldable	RaceSport	530	3,0	4,0	59,90 €
Race King 2.2 ProTecton									
0101486	0100540		26 x 2.2	black/black Skin foldable	ProTecton	545	3,0	4,0	62,90 €
0101467	0100913		27.5 x 2.2	black/black Skin foldable	ProTecton	570	3,0	4,0	62,90 €
0101473	0100546		29 x 2.2	black/black Skin foldable	ProTecton	605	3,0	4,0	62,90 €
Race King 2.2 Performance									
0150152			26 x 2.2	black/black Skin	Performance	670	3,5	4,5	25,90 €
0150304	0150033	55-559	26 x 2.2	black/black Skin foldable	Performance	669	3,5	4,5	32,90 €
0150292	0150092	55-584	27.5 x 2.2	black/black Skin foldable	Performance	699	3,5	4,5	32,90 €
0150296	0150036	55-622	29 x 2.2	black/black Skin foldable	Performance	748	3,5	4,5	32,90 €

Speed King



Per la massima scorrevolezza

Una scoltura leggera sulle spalle e un battistrada appena percepibile al centro: lo Speed King affascina per il disegno del suo profilo finalizzato ad ottenere la resistenza al rotolamento più bassa della gamma di prodotti mtb. È destinato soprattutto alle hardtail in carbonio e anche alle gravel bike. Dove il requisito principale è la leggerezza, lo Speed King è la scelta giusta. Il dna è da copertura da competizione, per questo la resa chilometrica è ridotta.

Le tuning par l'augmentation de la propulsion

Le Speed King sort du lot avec la géométrie de propulsion de son profil qui lui permet d'avoir la plus faible résistance au roulement de toute la palette des pneus VTT. Ce pneu de course et de tuning est utilisé avant tout sur les VTT de course et les hardtails en carbone. C'est le pneu à choisir partout où le poids est essentiel. Un pneu pur compétition avec un kilométrage réduit.

Traffic



Ciclismo nella giungla urbana

Il peculiare battistrada è stato sviluppato appositamente per l'utilizzo quotidiano delle MTB nel contesto cittadino e di campagna. La tassellatura centrale garantisce silenziosità e scorrevolezza sulla strada. La sua costruzione resistente e i fianchi robusti lo rendono un ottimo alleato contro le insidie delle grandi città: buche e marciapiedi. Disponibile anche con bande riflettenti, per una maggiore sicurezza.

À vélo à travers la jungle urbaine

Le design moderne de son profil a été développé pour l'utilisation du VTT au quotidien en ville et à la campagne. Sa bande de roulement centrale garantit un roulage toujours silencieux et rapide sur les routes. Sa construction massive et sa paroi latérale robuste font de lui le partenaire idéal contre les dangers de la circulation dans les grandes villes. Également disponible avec bandes réfléchissantes pour plus de sécurité.



model/code	etrto	dimension	color/sidewall	technology	weight g	bar	max. bar	price
Speed King 2.2 RS								
0100933	55-622	29 x 2.2	black/black Skin foldable	RaceSport	465	3,5	4,5	59,90 €
Traffic								
0100205	50-559	26 x 1.9	black/black	Sport	820	3,5	4,5	24,90 €
0100207	54-559	26 x 2.1	black/black	Sport	860	3,5	4,5	24,90 €

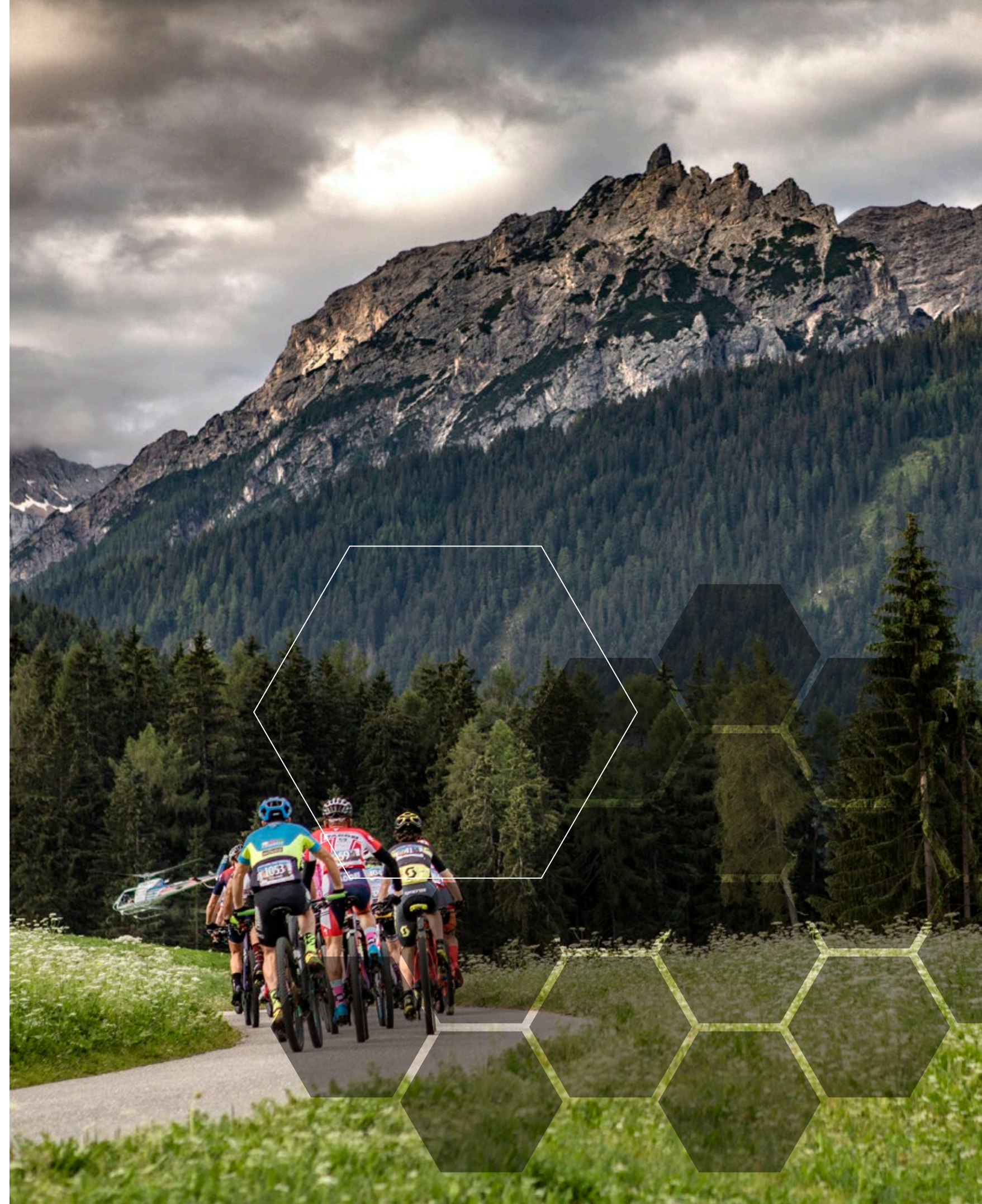

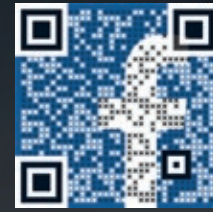

On our ContinentalMTB Facebook page you can find the latest videos of our mountain bike athletes in action, current news and inspiration for your next ride.



SAFETYPLUS

SafetyPlus Breaker - lo specialista tra i Breaker

Sviluppato specialmente per le e-bike fino a 50 km/h, combiniamo il nostro SafetySystem Breaker con una gomma ad alta flessibilità. Il risultato è un Breaker estremamente resistente ai tagli e alle perforazioni, con una resistenza al rotolamento sorprendentemente bassa, grazie alla sua elevata elasticità. Questo conserva l'energia e l'inerzia.

L'accelerazione rapida così come l'alta velocità di esecuzione delle curve non sono un problema per il Breaker.

È lo specialista per le e-bike veloci e per le bici a noleggio.

SafetyPlus Breaker - le spécialiste pour les E-bikes

Pour les E-bikes, nous avons combiné le SafetySystem Breaker avec un matériau hautement élastique. Le résultat est une enveloppe extrêmement résistante aux coupures et aux crevaisons qui, grâce à sa grande élasticité, offre surtout une faible résistance au roulement, économisant la batterie et l'environnement. Il est également conforme aux exigences de plus grande vitesse des E-bikes, pouvant aller jusqu'à 50 km/h. Il est également adapté pour le couple d'accélération plus élevé des vélos électriques ainsi que les vitesses plus rapides dans les virages. Le pneu spécial pour les E-bikes rapides et les vélos de locations.

Safety 

E 50



NONSTOP Mobility!

CONTACT Plus: Fino al **30 % in più** di maggiore protezione* contro le perforazioni di sassi e pietre acuminate!

* Test comparativo di resistenza alla foratura (al taglio), Istituto di Zedlere 2016.

Per maggiori informazioni visita <http://www.continental-tires.com/bicycle/technology/city-trekking/puncture-test>

CONTACT Plus: Jusqu'à 30% plus résistant à l'intrusion de tessons et de silex!

* Test comparatif de résistance aux perforations (lame), Institut Zedler 2016.

Pour plus d'informations, visitez <http://www.continental-tires.com/bicycle/technology/city-trekking/puncture-test>

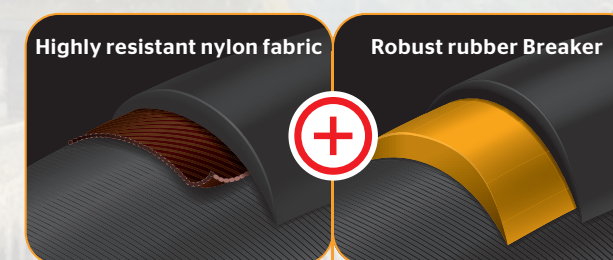

FAMIGLIE DI PRODOTTO / GAMMES

The Top CONTACT Family

- > la nostra linea Premium per i più elevati standard di qualità
- > le tecnologie più aggiornate con i materiali selezionati a mano
- > notre ligne Premium, gage des plus hauts standards de qualité
- > la toute dernière technologie, avec des matériaux assemblés à la main

The CONTACT Plus Family

- > massima protezione dalle forature per tutte le richieste
- > la protection maximale contre les crevaisons pour tous types de terrain

The CONTACT Family

- > pneumatici da prestazione per il ciclista ambizioso
- > des pneus performants pour cyclistes ambitieux

The RIDE Family

- > qualità per l'uso quotidiano
- > la qualité pour un usage quotidien



PASSIONE E MOBILITÀ

Che si tratti del tuo tragitto giornaliero o della tua uscita del fine settimana, puoi continuare a muoverti e arrivare in sicurezza. La nostra gamma di pneumatici è disegnata per ogni tuo bisogno, che sia la tua una city, una "retro" o una bici elettrica. Con un'incredibile gamma di dimensioni e di stili abbiamo la giusta copertura per te in modo da lasciarti pedalare sempre sicuro sulla strada.

PASSION ET MOBILITÉ

Que vous fassiez de votre vélo un usage quotidien ou plus occasionnel durant le week-end, vous voulez vous déplacer en toute sécurité. Vélo de ville, rétro ou électrique, notre gamme de pneus est conçue pour répondre à chacun de vos besoins. Grâce à notre vaste choix de dimensions et de modèles, nous avons le pneu qui vous correspond et vous permettra de profiter de chacune de vos sorties.

Vectran™ BREAKER	Top CONTACT II				Top CONTACT Winter II
Safety+	CONTACT Plus	CONTACT Plus City	CONTACT Plus Travel		
Safety System	CONTACT	CONTACT City	CONTACT Travel	CONTACT Cruiser	CONTACT Speed
IEXTRA Puncture BELT Puncture ProTection	RIDE Tour	RIDE City		RIDE Cruiser	RIDE Classic
	ALLROUND	CITY	TOUR	BALLOON	URBAN

CONTACT Speed



Unisce comfort e velocità

Uno pneumatico all'altezza di ogni sfida, con la velocità come punto di forza. Contact Speed è uno slick ad alta tenuta, con battistrada micropuntinato che si distingue particolarmente sull'asfalto. Grazie ad esso le city bike, le single speed e le fitness bike godranno al contempo del suo dinamismo e di un elevato grado di comfort. Oltre che per il particolare battistrada Contact Speed convince per il suo grip, per la sua scorrevolezza e la doppia protezione contro le forature.

Allie confort et vitesse

Son avantage est la vitesse. Le slick antipatinage avec profil rugueux est particulièrement adapté à l'asphalte. Les vélos de ville, à pignon fixe et d'entraînement profitent de sa dynamique tout en fournissant un grand confort. Ce pneu est ainsi en mesure de relever tous les défis. En plus de son nouveau design Vulcanette, le CONTACT Speed se distingue par son grip, sa fluidité et sa double protection anti-crevaison.

CONTACT Plus Reflex



Turismo a 360 gradi

Un all-rounder che offre tutto ciò che ci si aspetta da un confortevole pneumatico da turismo. È un all-rounder sia per l'asfalto che per il fuoristrada, che completa degnamente ogni bici da turismo. Grazie alla protezione dalle forature nessuno resterà fermo a bordo strada. In questa versione aggiornata il battistrada è stato migliorato. Dispone di certificazione ECE-R75.

Touring All-Rounder

Un all-rounder qui offre tout ce que vous attendez d'un pneu de tourisme confortable. Un All Rounder pour route et chemins qui habille chaque vélo de tourisme. Avec sa protection supplémentaire contre les crevaisons, personne ne sera laissé derrière sur le bord de la route. Une version mise à jour de la conception de la bande de roulement la plus populaire de tous nos pneus de tourisme. Certifié ECE-R75.



model/code	predecessor	etrto	dimension	color/sidewall	technology	weight g	bar	max. bar	price
CONTACT Speed									
0101412	0101098	37-622	28 x 1 3/8 x 1 5/8	black/black Skin	Double SafetySystemBreaker	520	5,0	6,0	28,90 €
0101416	0101102	42-622	700 x 42 C (40 C)	black/black Skin	Double SafetySystemBreaker	610	3,5	6,0	28,90 €
CONTACT Plus									
0101001		47-507	24 x 1.75	black/black Reflex	SafetyPlusBreaker	880	3,0	4,0	37,90 €
0101002		47-559	26 x 1.75	black/black Reflex	SafetyPlusBreaker	980	3,0	4,0	37,90 €
0101221		42-584	275 x 1 1/2	black/black Reflex	SafetyPlusBreaker	880	3,5	4,5	37,90 €
0101003		28-622	28 x 1 5/8 x 1 1/8	black/black Reflex	SafetyPlusBreaker	740	5,5	7,0	37,90 €
0101004		32-622	28x1 1/4 x 1 3/4	black/black Reflex	SafetyPlusBreaker	760	5,0	6,0	37,90 €
0101005		37-622	28 x 1 5/8 x 1 1/8	black/black Reflex	SafetyPlusBreaker	935	4,0	6,0	37,90 €
0101006		42-622	28 x 1.6	black/black Reflex	SafetyPlusBreaker	1.035	3,5	5,0	37,90 €
0101007		47-622	28 x 1.75	black/black Reflex	SafetyPlusBreaker	1.135	3,0	4,0	37,90 €
0101008		42-635	28 x 1 1/2	black/black Reflex	SafetyPlusBreaker	930	3,5	4,5	37,90 €
CONTACT Plus Travel Reflex									
101346	0100323	47-559	26 X 1.75	black/black Reflex	SafetyPlusBreaker	950	3,0	4,0	37,90 €
101347	0100438	50-559	26 X 2.00	black/black Reflex	SafetyPlusBreaker	1.000	3,0	4,0	37,90 €
101348	0100326	37-622	28 X 1 3/8 X 1 5/8	black/black Reflex	SafetyPlusBreaker	900	4,0	6,0	37,90 €

RIDE Tour



Compagno affidabile per il cicloturismo

Ride Tour è a proprio agio su ogni tipo di fondo, è un vero polivalente. La banda centrale del battistrada ha un design continuo, a garanzia di buone proprietà di rotolamento. Ulteriori punti di forza? L'ampia gamma di colori, di sezioni e la durata elevata.

Un compagnon fiable en randonnée

Le RIDE Tour est chez lui sur tous les terrains, c'est un véritable multitalent. Sa surface de roulement médiane continue assure de bonnes propriétés de roulement et offre en même temps suffisamment de traction ainsi qu'une grande sûreté dans les virages. Nos clients profitent de la vaste palette de tailles disponibles et de sa grande capacité de kilométrage.



Assieme ai fianchi in gomma rinforzata questa fettuccia costituisce un'elevata protezione contro forature e abrasioni. Disponibile in versione di pneumatico compatto con una forte propensione per la durezza.

Tous ceux qui recherchent un compagnon de tous les jours fiable choisiront un pneumatique avec EXTRA PunctureBELT. Ce dispositif de sécurité en caoutchouc robuste, combiné avec les flancs du pneu renforcés de caoutchouc, assure un haut niveau de protection contre les crevaisons et l'abrasion des flancs. Lorsque la longévité est l'objectif principal, il existe également une version pneu plein.



model/code	predecessor	etrto	dimension	color/sidewall	technology	weight g	bar	max. bar	price
RIDE Tour									
0101140		47-406	20 x 1.75	black/black	Extra Puncture Belt	585	3,0	4,0	13,90 €
0101143	0109003	47-507	24 x 1.75	black/black	Extra Puncture Belt	710	3,0	4,0	17,90 €
0101148		47-559	26 x 1.75	black/black	Extra Puncture Belt	805	3,0	4,0	17,90 €
0101146	0111348	42-584	26 x 1 1/2	black/black	Extra Puncture Belt	675	3,5	4,5	17,90 €
0101150	0100100	54-584	26 x 1 1/2 x 2	black/black	Extra Puncture Belt	940	3,0	4,0	17,90 €
0101151		28-622	700x28C (700C)	black/black	Extra Puncture Belt	510	5,0	5,5	17,90 €
0101153		32-622	28 x 1 1/4 x 1 3/4	black/black	Extra Puncture Belt	570	5,0	5,5	17,90 €
0101155		37-622	28 x 1 3/8 x 1 5/8	black/black	Extra Puncture Belt	650	4,0	5,0	17,90 €
0101177	0122299	37-622	28 x 1 3/8 x 1 5/8	creme/creme	Extra Puncture Belt	650	4,0	5,0	17,90 €
0101157		42-622	28 x 1.6	black/black	Extra Puncture Belt	720	3,5	4,5	17,90 €
0101159		47-622	28 x 1.75	black/black	Extra Puncture Belt	910	3,0	4,0	17,90 €
0101179	0111354	47-622	28 x 1.75	black/brown	Extra Puncture Belt	910	3,0	4,0	17,90 €
RIDE Tour Reflex									
0101152		28-622	700x28C (700C)	black/black Reflex	Extra Puncture Belt	510	5,0	5,5	20,90 €
0101154		32-622	28 x 1 1/4 x 1 3/4	black/black Reflex	Extra Puncture Belt	570	5,0	5,5	20,90 €
0101156	0122292	37-622	28 x 1 3/8 x 1 5/8	black/black Reflex	Extra Puncture Belt	650	4,0	5,0	20,90 €
0101167		42-622	28 x 1.6	black/black Reflex	Extra Puncture Belt	720	3,5	4,5	20,90 €
0101160	0111347	47-622	28 x 1.75	black/black Reflex	Extra Puncture Belt	910	3,0	4,0	20,90 €
0101162	0100091	32-630	27 x 1 1/4	black/black Reflex	Extra Puncture Belt	570	5,0	5,5	20,90 €
0101164	0100095	37-635	28 x 1 3/8	black/black Reflex	Extra Puncture Belt	655	4,0	5,0	20,90 €
0101166	0126102	42-635	28 x 1 1/2	black/black Reflex	Extra Puncture Belt	725	3,5	4,5	20,90 €

PASSIONE E ACCESSORI PRATICI

I piccoli dettagli fanno la differenza. Che si tratti di montare lo pneumatico sul cerchio o di riparare una foratura, che sia sulla strada o nell'officina di casa, le tue coperture necessitano del migliore servizio e del miglior supporto. Nelle prossime pagine troverai utili accessori che ti aiuteranno il più possibile a risolvere gli aspetti pratici del tuo sport senza problemi. Dalla giusta camera d'aria ai giusti cerchi passando per gli adeguati levagomme e per i sigillanti efficienti, noi abbiamo sempre qualcosa di utile per il tuo prossimo progetto.

ACCESSOIRES PRATIQUES ET SYMPAS.

Les petits détails font la différence. Qu'il s'agisse de monter le pneu sur la jante ou d'effectuer de petites réparations, au bord de la route comme à la maison, vous pouvez être sûr que vos pneus bénéficieront du meilleur service et d'une assistance adéquate. Dans les pages suivantes, vous trouverez des accessoires très utiles pour rendre les aspects techniques de la pratique sportive aussi agréables que possible. Vous cherchez un modèle spécifique, des jantes adaptées à votre vélo, un démonte-pneu pratique ou un produit anti-crevaison efficace ? Nous avons ce qu'il vous faut!

Camere d'aria per biciclette e accessori / Chambres à air et accessoires

Camere d'aria / Chambres à air

model/code	etrto	dimension	description	price
MTB				
0181631	47-559 > 62-559	S42	MTB 26	7,50 €
0181671	47-559 > 62-559	S60	MTB 26	8,50 €
0182311	47-584 > 62-584	S42	MTB 27,5	7,50 €
0182181	47-622 > 62-662	S42	MTB 28 / 29 inch	7,50 €
0182191	47-622 > 62-662	S60	MTB 28 / 29 inch	8,50 €
Tour				
0181521	37-559 > 47-597	S42	Tour 26	7,50 €
0182031	32-622 > 47-622	S42	Tour 28 all	7,50 €
Race				
0181781	18-622 > 25-630	S42	Race 28	7,50 €
0181791	18-622 > 25-630	S60	Race 28	8,50 €
0180000	18-622 > 25-630	S80	Race 28	9,50 €
0181821	18-622 > 25-630	S42	Race 28 Light	9,50 €
0181831	18-622 > 25-630	S60	Race 28 Light	10,50 €
0181871	18-622 > 25-630	S80	Race 28 Light	12,50 €
Race 28 Super Sonic				
0181881	18-622 > 25-630	S42	Race 28	14,50 €
0181891	18-622 > 25-630	S60	Race 28	15,50 €

Tubular Kit



Tube bag



Conti RevoSealant



Accessori / Accessoires

model/code	description	weight g	price
Tubular kit			
0149091	Rim cement for aluminium / tubo da 25 g	25	2,90 €
0149092	Rim cement for aluminium / barattolo da 350 g	350	16,90 €
0140016	Rim cement for carbonrims / tubo da 25 g	25	2,90 €
0140017	Rim cement for carbonrims / barattolo da 250 g	250	16,90 €
Tube bag			
0100388	Tube bag / Race 28 S42 tube and 2 tire lever race	160	9,90 €
0101026	Tube bag with MTB 29 tube S42 and 2 tire levers MTB	320	10,90 €
Sealant			
0140089	Continental RevoSealant 60 ml	60 ml	5,90 €
0140044	Continental RevoSealant 240 ml	240 ml	10,00 €
0140050	Continental RevoSealant 1000 ml	1.000 ml	35,90 €
Others			
0140033	Valve extension for presta valve aluminium 40 mm / 10 pcs	-	44,90 €
0149690	Exchangeable presta valve insert / bag of 10 pcs	10	5,50 €
0140030	Valve extension for presta valve aluminium 30 mm, 2pcs	30	9,90 €
0140032	Valve extension for presta valve aluminium 40 mm, 2pcs	40	9,90 €
0140034	Valve extension for presta valve aluminium 60 mm, 2pcs	60	10,90 €

PASSIONE E TECNOLOGIA TEDESCA

Produrre i migliori pneumatici è il nostro imperativo. Per questo i nostri designer ed ingegneri sono sempre impegnati a rendere i nostri prodotti più efficienti, ad esempio sviluppando o migliorando formulazioni per le nostre mescole. Queste innovazioni spesso non sono evidenti a prima vista, ma sono decisamente rimarchevoli. Pedala la differenza, pedala il "fatto a mano in Germania".

LA PASSION ET LA TECHNOLOGIE ALLEMANDES

Notre objectif: produire les meilleurs pneus au monde. C'est la raison pour laquelle nos designers et ingénieurs travaillent en permanence à l'amélioration de nos produits, développant par exemple régulièrement de nouveaux mélanges de gomme ou améliorant les formules existantes. Si ces changements ne sont pas toujours visibles au premier coup d'œil, vous les remarquerez à l'usage sans aucun doute! Sentez la différence, appréciez le fait main "Made in Germany".

TECNOLOGIA MADE IN GERMANY TUTTO È IN BASE A COME LO MESCOLI TECHNOLOGIE MADE IN GERMANY. A VOUS DE JOUER!

Well built [carcass design]

La carcassa, ossia l'elemento fondamentale e la colonna dorsale di tutti gli pneumatici. Il suo differente design, i materiali usati e la densità delle sue fibre dipendono dalle richieste che deve soddisfare la gomma. Affinché i nostri prodotti garantiscano il piacere del pedalare lavoriamo solamente con intrecci di carcassa ad alta qualità e fili di nylon gommati. La densità dell'intreccio della carcassa assegna allo pneumatico le sue caratteristiche specifiche. La densità del filato è espressa in Tpi (fili per pollice) e indica il numero di fili ogni 2.54 cm. Una carcassa di base a tre strati costituisce lo standard. Un tessuto molto sottile rende lo pneumatico flessibile e rinforza la carcassa rispetto alle forature. Il tessuto ruvido è più resistente al taglio e rende la copertura più durevole. In più, utilizziamo una fettuccia antiforatura al di sotto del battistrada, fatta di vari materiali per rinforzare ulteriormente lo pneumatico. La precisa struttura della copertura può essere trovata nelle singole specifiche tecniche. Sono riportati il numero degli strati della carcassa, il totale dei fili per pollici (Tpi) e il tipo di protezione dalle forature: 3/330 + Vectran significa tre strati di tessuto da 110 Tpi uniti con la fettuccia Vectran™ Breaker.

Well built [carcass design] / La carcasse - la colonne vertébrale du pneu

Le design, les matériaux et la densité des fibres composant la carcasse dépendront de l'usage auquel on destine le pneu. Afin de garantir une expérience agréable aux cyclistes les plus endurants, nous utilisons exclusivement des carcasses de qualité supérieure avec une structure en nylon tissé qui est ensuite caoutchoutée. La densité des fils de nylon composant la carcasse confère au pneu ses propriétés spécifiques. Elle est indiquée en TPI (Threads per inch) ce qui correspond au nombre de fil tous les 2,54cm. Une carcasse standard comprend trois épaisseurs. Une structure très fine garantit la souplesse du pneu et renforce la carcasse par rapport aux crevaisons. Une structure plus épaisse sera plus résistante aux coupures et rendra le pneu plus durable.

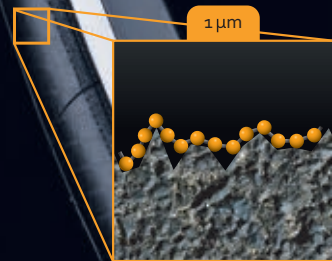
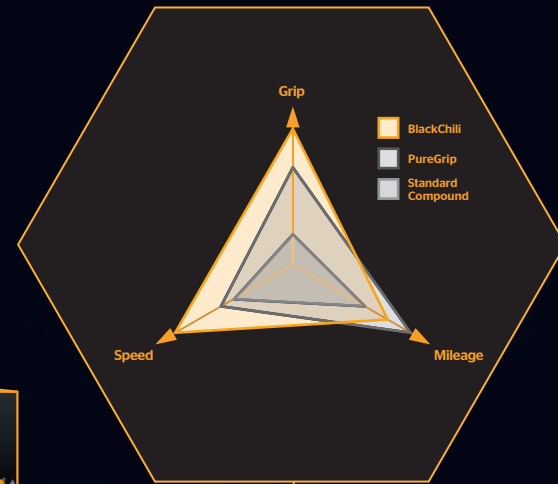

TWI [Tread Wear Indicators] è l'indicatore dell'usura del battistrada.

Due depressioni circolari al centro del battistrada: quando queste non sono più visibili è ora di cambiare la copertura (per il segmento "Corsa Strada agonistico"). Esattamente come sulle autovetture ci sono piccole sagome preformate nel battistrada, a indicare lo spessore minimo di 1.6 millimetri (per il segmento City/Trekking).

TWI [Tread Wear Indicators] the indicator for tread wear

Deux marqueurs d'usure de forme arrondie figurent au milieu de la bande de roulement: lorsqu'ils ne sont plus visibles, il est temps de changer de pneu (segment Road Racing). Comme pour les pneus de voiture, de petites barres dans la bande de roulement indiquent lorsque la gomme a atteint son épaisseur minimale de 1,6mm (segment City/Trekking)."

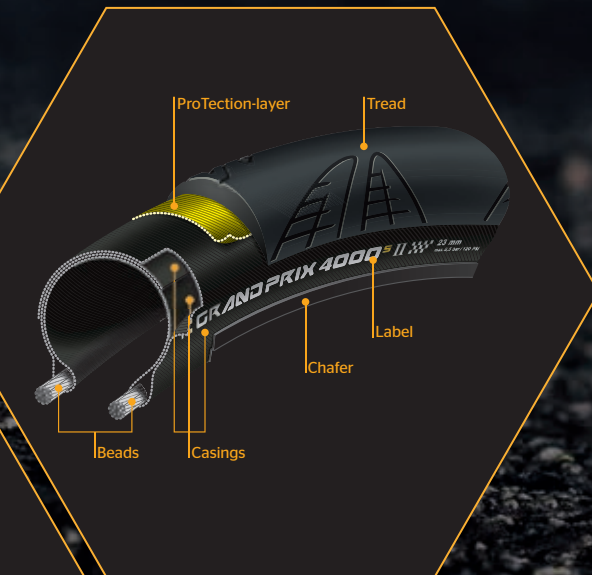

LES INFORMATIONS CONTENUES DANS CETTE BROCHURE
NE REMPLACENT EN AUCUN CAS LA RELATION DIRECTE
ENTRE LE PROFESSIONNEL DE LA SANTÉ ET LE PATIENT.
PAR CONSÉQUENT, IL EST TOUJOURS CONSEILLÉ DE CONSULTER
VOTRE MÉDECIN TRAITANT ET/OU VOTRE PHARMACIEN.

NAMEDSPORT[®]
SUPERFOOD

NAMEDSPORT> Superfood Nous nourrissons les passions.

Avec des produits ciblés et de haute qualité, conçus selon un concept résolument innovant, **NAMEDSPORT>** Superfood offre au sportif une alimentation complète et équilibrée qui lui garantit une performance athlétique optimale et tous les nutriments nécessaires avant, pendant et après l'activité sportive. Les compléments **NAMEDSPORT>** permettent d'optimiser les performances et les temps de récupération, favorisant un état de bien-être général. Des formulations efficaces et de pointe, qui comptent parmi leurs ingrédients des matières premières d'excellence et qui sont le fruit d'un travail de recherche passionné, mené en collaboration avec une équipe d'experts : entraîneurs sportifs, médecins du sport, chercheurs scientifiques, kinésithérapeutes et nutritionnistes. Leur efficacité, dans le respect des réglementations en vigueur et de la santé, est attestée chaque jour par des sportifs de très haut niveau.



Sponsor principal du 101^e Giro d'Italia, **NAMEDSPORT>** a été sélectionnée en tant que partenaire nutritionnel par les équipes Pro-Tour les plus accréditées au monde telles que Astana, Trek-Segafredo, Bahrain-Merida, UAE Team Emirates.

NAMEDSPORT> Nous nourrissons une passion pour vos passions.

Tous les compléments alimentaires NAMEDSPORT> sont notifiés au Ministère de la Santé et sont conformes aux réglementations italiennes et européennes en matière de suppléments.



LA VUELTA
OFFICIAL SPONSOR

Alimentation et sport

Pour les athlètes, plus encore que pour les sujets sédentaires, il est important de conserver une alimentation correcte et équilibrée. Celle-ci garantit à l'organisme un apport suffisant en nutriments essentiels pour remplir les fonctions physiologiques, favoriser le maintien ou la croissance de la masse musculaire, optimiser les performances et compenser les carences liées au stress psychophysique engendré par une activité sportive intense. Le métabolisme correct des macronutriments (glucides, protéines et graisses) et leur transformation en glucose et glycogène pour produire de l'énergie sont des processus clés pour offrir aux athlètes la force nécessaire à la bonne exécution des activités, pendant l'entraînement comme en compétition.

Suivre une alimentation équilibrée signifie varier chaque jour son régime, **en alternant fréquemment les aliments** - céréales, légumineuses, viande, lait, fruits et légumes - pour être sûr(e) de **prendre tous les nutriments** nécessaires.

Pour les sportifs, les besoins caloriques quotidiens peuvent varier de 2.000 à 5 000 kcal selon le sexe, l'âge ou l'intensité et la durée de l'effort. Le concept de « bilan énergétique » exprime la nécessité d'introduire davantage d'aliments, proportionnellement à l'activité et à l'énergie consommée. Dans certains cas, un mode de vie stressant, une activité professionnelle intense, des rythmes frénétiques et décalés rendent difficile de suivre une alimentation correcte et équilibrée, réduisant ainsi la possibilité de fournir, par le biais de l'alimentation, un apport équilibré en nutriments essentiels au bien-être et à la bonne exécution des activités.



Official Sponsor of



NAMEDSPORT> certifier la qualité avec INFORMED-SPORT.

Informed-Sport est un programme de certification de qualité, reconnu à l'échelle mondiale, établi pour garantir que tous les compléments alimentaires ou les ingrédients portant le logo «Informed-Sport» ont été testés par LGC, un prestigieux laboratoire international de recherche et de contrôle antidopage, ayant à son actif 50 années d'expertise. Celui-ci analyse les formulations les plus diverses, à travers des tests spécifiques et pointus, permettant d'exclure la présence de plus de 146 substances (y compris les stimulants, les agents masquants, les anabolisants...) dont l'usage est interdit dans le sport.

NAMEDSPORT> est actuellement la première et la seule marque italienne à avoir réussi, avec le produit HydraFit>, à entrer dans le programme Informed-Sport. À ce programme peuvent accéder seules les entreprises qui sont à même de garantir un suivi constant des processus d'assurance et de contrôle de la qualité et qui parviennent à passer un grand nombre de tests rigoureux et d'analyses pointues.

Le logo Informed-Sport est reconnu par les plus grands acteurs du monde du sport comme **une garantie officielle de qualité et de sécurité**, et représente une prérogative exclusive réservée aux entreprises considérées comme les plus fiables et les plus accréditées dans le domaine de la nutrition sportive. Le consommateur final, amateur ou professionnel, est ainsi assuré de pouvoir consommer le produit en toute tranquillité. De surcroît, la certitude absolue de l'absence de substances interdites est garantie par la possibilité de suivre et de vérifier, également via un smartphone, **le résultat des analyses menées sur chaque lot de production**, publié en temps réel sur le site www.informed-sport.com.

100%
Batch tested:
INFORMED-SPORT
Trusted by sport

Cluster 1 >



code SP500bis
description Cluster 1
box 60
price per box 5,99 €

Cluster 1 > contains:

PalBox KIT HYDRAFIT / 60x400g



+ MAGNÉSIUM + POTASSIUM

WITH VITAMINS WITH MINERALS GLUTEN FREE
 ASPARTAME FREE ACESULFAME FREE LACTOSE FREE

Cluster 2 >



code NAMCLUS020000
description Cluster 2

Cluster 2 > contains:

code	description		box
K013	AMINONAM SPORT	30 sachet	1
SP917	CREAMY PROTEIN 80 Exquisite Chocolate	500g	1
SP919	CREAMY PROTEIN 80 Cookies & Cream	500g	1
SP82	MALTONAM	500g	1
SP12	ISONAM ENERGY Lemon	480g	1
SP13	ISONAM ENERGY Orange	480g	1
SP21	4FUEL	20 sachet	1
SP151	TOTAL ENERGY SHOT Orange	60ml	50
SP692	PROTEINBAR Cookies & Cream	50g	12
SP8341	TOTAL ENERGY FRUIT BAR Cranberry & Nuts	35g	25
SP8361	TOTAL ENERGY FRUIT BAR Yellow Fruits	35g	25
SP8381	TOTAL ENERGY CARBO GEL Agrumix	40ml	24
SP9361	TOTAL ENERGY AMINO GEL Orange Flavour	50ml	32
SP9381	SPORT GEL Orange	25ml	15
SP9402	SPORT GEL Cola Lime	25ml	15
ES-44	Display	-	1



Snack



protein
32%

BEFORE DURING AFTER



Valeurs nutritionnelles moyennes

	Pour 100 g	Par barre (40 g)
Énergie	1819 kJ/435 kcal	730 kJ/173 kcal
Lipides	17 g	6,8 g
dont acides gras saturés	10 g	4 g
Glucides	38 g	15 g
dont sucres	24 g	10 g
Fibres	0,9 g	< 0,5 g
Protéines	32 g	13 g
Sel	0,5 g	0,19 g

Crunchy Protein Bar

Délicieuse barre protéinée à 32%. L'enrobage de chocolat croquant renferme un fourrage moelleux à base d'un mélange de protéines de soja isolées et de protéines de lait concentrées, à valeur biologique élevée, qui aident au maintien de la masse musculaire.

- > **32% de protéines par barre**
- > **Idéale pour réintégrer les protéines après l'entraînement**
- > **Facile à digérer**
- > **Faible teneur en matières grasses et en sucres**

GREAT TASTE ASPARTAME FREE ACESULFAME FREE

code	description	content	box	price
SP799	Crunchy Proteinbar Capuccino	40g	24	€ 2,80
SP792	Crunchy Proteinbar Lemon-Tarte	40g	24	€ 2,80
SP796	Crunchy Proteinbar Raspberry Dream	40g	24	€ 2,80

protein
35%

BEFORE DURING AFTER



Valeurs nutritionnelles moyennes

	Pour 100 g	Par barre (50 g)
Énergie	1636 kJ/390 kcal	818 kJ/195 kcal
Lipides	12 g	6,2 g
dont acides gras saturés	4,0 g	2,0 g
Glucides	34 g	17 g
dont sucres	30 g	15 g
Fibres	7,0 g	3,5 g
Protéines	34 g	17 g
Sel	25 mg	12 mg

Proteinbar

Barre protéinée à base de protéines de lactosérum concentrées et isolées, avec huile de tournesol pressée à froid et enrobage de chocolat noir.

- > **35% de protéines**
- > **17g de protéines par barre**
- > **Idéale avant et après l'entraînement**
- > **Parfaite comme en-cas entre les repas**
- > **Teneur élevée en protéines, équilibrée en glucides**

GREAT TASTE ASPARTAME FREE ACESULFAME FREE GLUTEN FREE PALM OIL FREE

code	description	content	box	price
SP651	Proteinbar Coconut	50g	12	€ 2,60
SP692	Proteinbar Cookies & Cream	50g	12	€ 2,60
SP631	Proteinbar Delicious Pistachio	50g	12	€ 2,60
SP641	Proteinbar Superior Choco	50g	12	€ 2,60
SP661	Proteinbar Wild Berries	50g	12	€ 2,60

30%
PROTEIN
PLANT-BASED

BEFORE DURING AFTER



Valeurs nutritionnelles

	Pour 100 g	Par barre (40 g)
Énergie	1610 kJ/382 kcal	644 kJ/153 kcal
Lipides	10 g	4 g
dont acides gras saturés	3,3 g	1,3 g
Glucides	45 g	18 g
dont sucres	18 g	7 g
Protéines	29 g	12 g
Sel	1 g	0,44 g

Vegan Protein Bar

Délicieuses barres protéinées à 30%, idéales à consommer dans le cadre d'un régime végétarien et végétalien. Grâce aux caractéristiques nutritionnelles des protéines de soja et de pois, les Vegan Bar offrent un profil nutritionnel complet, particulièrement adapté aux personnes attentives à leur bien-être et à leur forme physique.

- > **30% de protéines de soja et de pois**
- > **Sans huile de palme**
- > **Recette 100% végétalienne**
- > **Avec de vrais fruits**
- > **Goût excellent**

GREAT TASTE ASPARTAME FREE ACESULFAME FREE GLUTEN FREE PALM OIL FREE

code	description	content	box	price
SP794	Vegan Protein Bar Nuts	40g	24	€ 3,00
SP793	Vegan Protein Bar Red Fruits	40g	24	€ 3,00

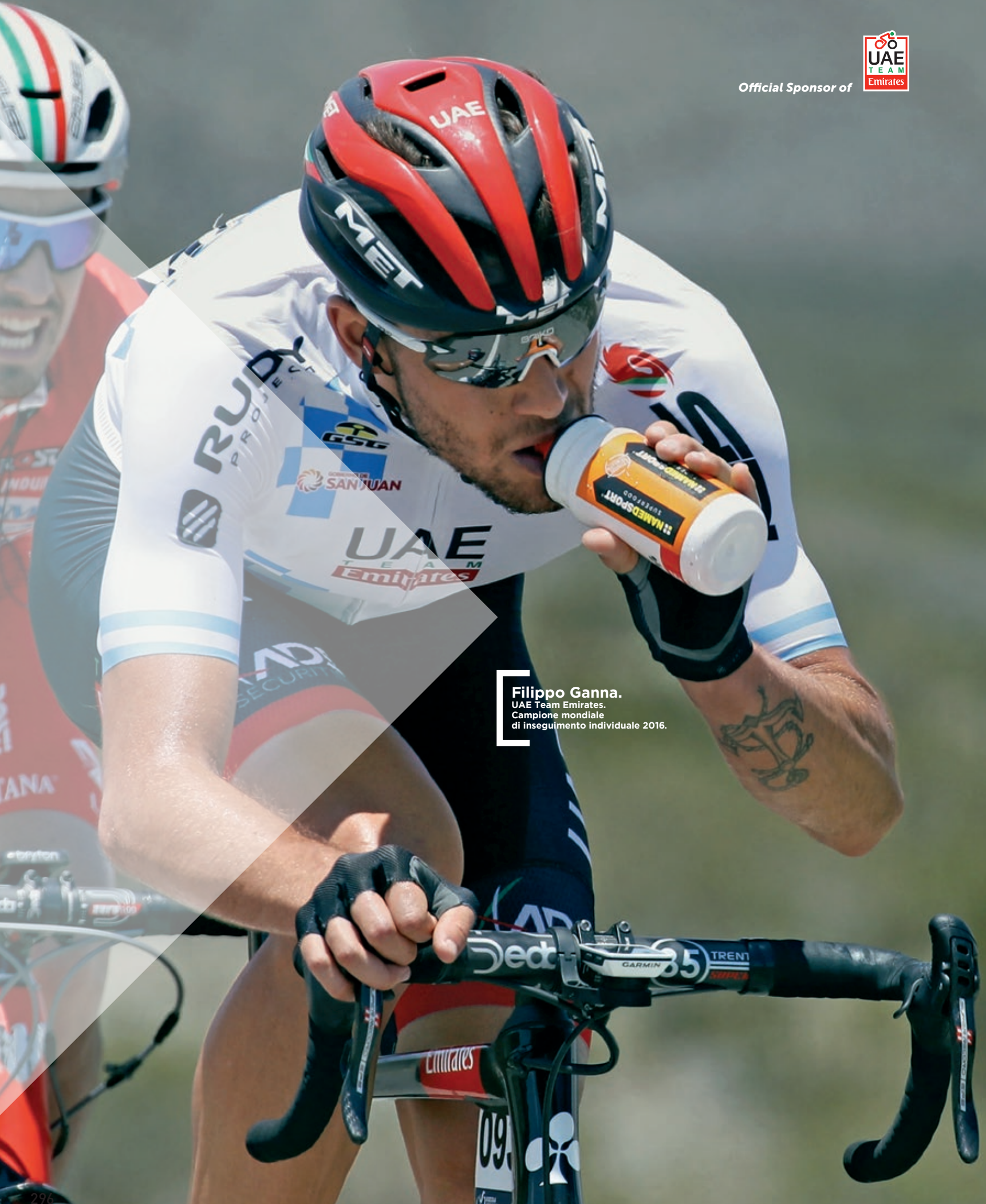

Official Sponsor of

Filippo Ganna.
UAE Team Emirates.
Campione mondiale
di Inseguimento individuale 2016.



BEFORE DURING AFTER

FAST ENERGY

WITH REAL FRUIT



- + VITAMINE C
- + VITAMINE B1
- + VITAMINE B6

Valeurs nutritionnelles moyennes

	Pour 100 g	Par barre (35 g)	%*VNR
Énergie	1414 kJ/ 335 kcal	495 kJ/ 117 kcal	
Lipides	6 g	2,1 g	
dont acides gras saturés	0,6 g	0,2 g	
Glucides	64 g	22,4 g	
dont sucres	48 g	16,8 g	
Fibre	4,5 g	1,6 g	
Protéines	4 g	1,4 g	
Sel	0,25 g	0,09 g	
Vitamine C	35 mg (43 % VNR)	12 mg	15 %
Thiamine	0,48 mg (43 % VNR)	0,17 mg	15 %
Vitamine B6	0,60 mg (43 % VNR)	0,21 mg	15 %

* VNR= valeur nutritionnelle de référence pour l'apport quotidien (adultes) selon le Rég. UE 1169/2011

Total Energy Fruit Bar

Délicieuse barre énergétique avec du riz soufflé et de vrais fruits, enrichie en vitamines B1, B6 et vitamine C, spécialement formulée pour être consommée avant et pendant l'effort pour un apport rapide en énergie pendant l'activité sportive.

- > **Idéale pour les sports d'endurance**
- > **Avec vitamines B1 et B6**
- > **Contribue à protéger les cellules contre le stress oxydatif**
- > **La vitamine B6 aide à contrer la fatigue et l'asthénie**
- > **La vitamine B1 favorise le métabolisme énergétique**

GREAT TASTE ASPARTAME FREE ACESULFAME FREE

code	description	content	box	price
SP8341	Total Energy Fruit Bar Cranberry & Nuts	35g	25	€ 2,00
SP8371	Total Energy Fruit Bar Fruit Caribe	35g	25	€ 2,00
SP8351	Total Energy Fruit Bar Fruit Tango	35g	25	€ 2,00
SP8361	Total Energy Fruit Bar Yellow Fruits	35g	25	€ 2,00

BEFORE DURING AFTER

FAST ENERGY

30g CARBS



Valeurs nutritionnelles

	Pour 100 g	Par barre (35 g)
Énergie	1613 kJ/381 kcal	564 kJ/133 kcal
Lipides	2,8 g	1,0 g
dont acides gras saturés	0,5 g	0,2 g
Glucides	85 g	30 g
dont sucres	45 g	16 g
Fibres	4,0 g	1,4 g
Protéines	2,0 g	0,7 g
Sel	350 mg	122 mg

* VNR= Valori Nutritivi di Riferimento giornaliero (adulti) ai sensi del Reg. UE 169/2011

Energybar

Délicieuse barre énergétique avec du riz soufflé et de vrais fruits, enrichie en vitamines B1, B6 et vitamine C, spécialement formulée pour être consommée avant et pendant l'effort pour un apport rapide en énergie pendant l'activité sportive.

- > **Idéale pour les sports d'endurance**
- > **Avec vitamines B1 et B6**
- > **Contribue à protéger les cellules contre le stress oxydatif**
- > **La vitamine B6 aide à contrer la fatigue et l'asthénie**
- > **La vitamine B1 favorise le métabolisme énergétique**

GREAT TASTE ASPARTAME FREE ACESULFAME FREE

code	description	content	box	price
SP5311	Energybar Apricot	35g	12	€ 1,90
SP5411	Energybar Banana	35g	12	€ 1,90
SP5511	Energybar Strawberry	35g	12	€ 1,90



Acides aminés



Official Sponsor of

BEFORE DURING AFTER

VITAMIN B6

ANTI CATABOLIC POOL



Valeurs nutritionnelles moyennes

	Pour 100 g	Pour 16 g (dose maxi/jour)	% VNR**
Énergie	379kJ/89,7kcal	60,7kJ/14,3kcal	--
Lipides	1,5 g	0,24 g	--
dont acides gras saturés	1,3 g	0,20 g	--
Glucides	7,81 g	1,25 g	--
dont sucres	0,40 g	0,06 g	--
Protéines	0,0 g	0,0 g	--
Sel	2,34 g	0,375 g	--

*Acides aminés AJINOMOTO® Sans gluten
** VNR : valeur nutritionnelle de référence pour l'apport quotidien (adultes) selon le Rég. UE 1169/2011. Produit inscrit au registre des suppléments du Ministère italien de la santé, code 49482

Aminonam Sport

Aminonam Sport est un pool exclusif d'acides aminés Ajinomoto®, purs et hautement sélectionnés, avec l'ajout de vitamines du groupe B, idéal pour contribuer au métabolisme énergétique normal.

- > Il favorise un métabolisme énergétique normal grâce aux vitamines B1, B6 et B12
- > Il aide à contrer la fatigue et l'asthénie grâce aux vitamines B6 et B12
- > La vitamine B6 contribue au métabolisme normal des protéines et du glycogène

GLUTEN FREE LACTOSE FREE WITH BCAA WITH VITAMINS NO SUGAR ADDED

code	description	content	box	price
K013	Aminonam Sport	30 sachet	1	€ 39,99

Teneur moyenne en acides aminés

	Pour 100 g	Pour 16 g (dose maxi/jour)	% VNR**
Vitamine B6	8,75 mg (625 % VNR)	1,4 mg	100
Thiamine	6,87 mg (625 % VNR)	1,1 mg	100
Vitamine B12	15,62 mcg (625 % VNR)	2,5 mcg	100
L-leucine*	15,62 g	2500 mg	--
L-alanine*	15,62 g	2500 mg	--
L-lysine HCL*	10,15 g	1624 mg	--
L-isoleucine*	7,81 g	1250 mg	--
L-valine*	7,81 g	1250 mg	--
Glycine*	6,25 g	1000 mg	--
L-thréonine*	4,37 g	700 mg	--
L-tyrosine*	3,75 g	600 mg	--
Taurine*	2,50 g	400 mg	--
L-histidine*	1,87 g	300 mg	--
L-cystéine*	1,56 g	250 mg	--
L-arginine base*	1,25 g	200 mg	--
L-glutamine*	1,25 g	200 mg	--
L-phénylalanine*	1,12 g	180 mg	--
L-méthionine*	0,94 g	150 mg	--
L-tryptophane*	0,37 g	60 mg	--

BEFORE DURING AFTER

ANTICATABOLIC AMINO ACIDS

FERMENTED GLUTAMINE



180 MESH

L-Glutamine

L-Glutamine est un complément de L-glutamine KyowaQuality®.

- > Micronisée, pure à 100%
- > Sans lactose
- > Solubilité élevée
- > Absorption rapide

La glutamine est l'acide aminé prédominant dans les tissus musculaires et peut s'avérer utile dans les activités sportives si elle est prise:

- > Une heure avant le début de l'effort combinée à des glucides
- > Immédiatement après l'entraînement, dans les 30 minutes qui suivent l'exercice, avec beaucoup de liquides et d'autres acides aminés
- > À jeun, avant le coucher

code	description	content	box	price
SP421	L-Glutamine	250g	1	€ 25,99

Teneur moyenne

	Pour 1 dosette (dose maxi/jour)	Pour 100 g
L-glutamine*	5 g	100 g

* L-glutamine KyowaQuality®

BEFORE DURING AFTER

VITAMIN B6

FERMENTED BCAA PREPARATE

SUPER CHARGED FORMULA



Teneur moyenne

	Pour 5 cpr (dose maxi/jour)	% VNR**
L-leucine*	3333 mg	--
L-isoleucine*	833 mg	--
L-valine*	833 mg	--
Vitamine B6	1,4 mg	100

* Acides aminés Ajinomoto Quality®
** VNR : valeur nutritionnelle de référence pour l'apport quotidien (adultes) selon le Rég. UE 1169/2011. Produit inscrit au registre des suppléments du Ministère italien de la santé, code 70812.

BCAA 4:1:1 extreme PRO

BCAA 4:1:1 extremePRO est un complément d'acides aminés à chaîne ramifiée Ajipure® (1g/comprimé) de la plus grande pureté ; formule sans lipides, ni glucides, ni gluten, ni lactose.

- > Les acides aminés à chaîne ramifiée interviennent dans les processus de synthèse protéique
- > Favorise la récupération
- > La vitamine B6 aide à contrer la fatigue et l'asthénie
- > Formule améliorée 4:1:1 Plus Leucine

BCAA 4:1:1 extremePRO contient de la vitamine B6 qui intervient dans le métabolisme énergétique des glucides, des lipides et des protéines ainsi que dans la synthèse de l'hémoglobine et des globules rouges.

VEGAN FRIENDLY GLUTEN FREE LACTOSE FREE WITH VITAMIN B6 NO SUGAR ADDED



code	description	content	box	price
SP604	BCAA 4:1:1 extremePRO	110 cpr	1	€ 26,99

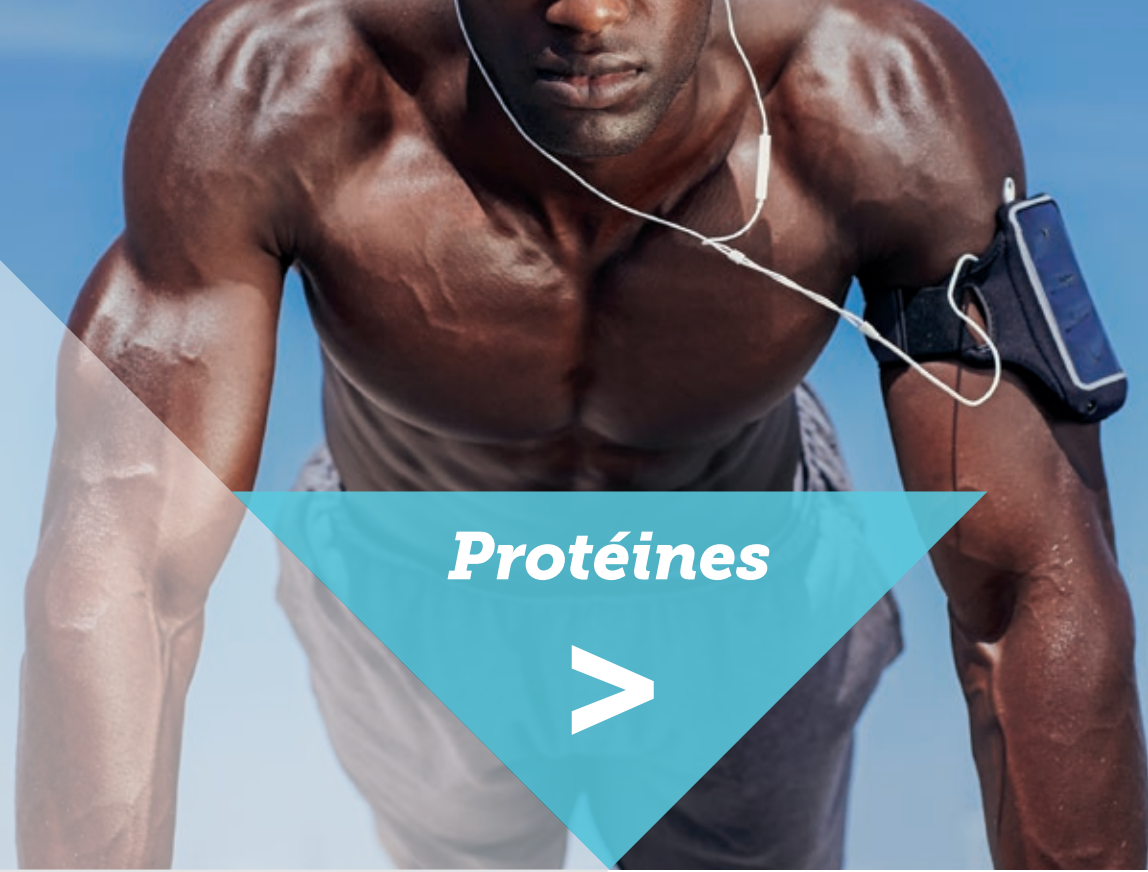

Protéines



Mind the shape



BEFORE DURING AFTER



Star Whey PERFECT ISOLATE 100%

THE PUREST ISOLATE PROTEIN FORMULA

De la recherche Named naît Star Whey PERFECT ISOLATE 100%: Protéines de lactosérum isolées de la plus pure qualité CARBERY® Isolac 90, obtenues par micro filtration croisée (Cross-Flow-Micro-filtration-CFM®), qui se distinguent par leur pureté inégalée. Le procédé d'extraction particulier permet d'obtenir un produit d'une qualité exceptionnelle, atteignant la plus haute valeur biologique (119) et le profil en acides aminés le plus complet. Star Whey est enrichi avec la formule exclusive brevetée Named 4 Protein Matrix®, à base de protéase, extrait de fenugrec et colostrum bovin.

- > Les protéines favorisent le maintien de la masse musculaire
- > Valeur biologique élevée de la protéine
- > Large spectre d'acides aminés
- > Faible teneur en matières grasses et en lactose
- > Facile à digérer
- > Enrichi avec la combinaison exclusive Named 4 Protein Matrix®

ASPARTAME FREE ACESULFAME FREE WITH VITAMINS INSTANTLY SOLUBLE GLUTEN FREE
RAPID DIGESTION RICH IN BCAA NO SUGAR ADDED LOW LACTOSE WITH ENZYMES

code	description	content	box	price
SP809	Star Whey Isolate Cookies & Cream	750g	1	€ 46,99
SP808	Star Whey Isolate Sublime Chocolate	750g	1	€ 46,99

Valeurs nutritionnelles moyennes		
	Pour 100 g	Pour 25 g (dose maxi/jour)
Énergie	1749 kJ/413 kcal	437 kJ/103 kcal
Lipides	3,46 g	0,86 g
dont acides gras saturés	1,09 g	0,27 g
Gluclides	5,35 g	1,34 g
dont sucres	3,24 g	0,81 g
Fibres	0,17 g	0,04 g
Protéines	90 g	22,5 g
Set	0,62 g	0,16 g
Teneur moyenne		
Vitamine B6	2,8 mg	0,7 mg
Vitamine B2	2,8 mg	0,7 mg
Vitamine B1	2,2 mg	0,55 mg
NAMED 4PROTEIN MATRIX®	4 g	1 g
dont saponines stéroïdes	80 mg	20 mg
dont diosgénine	1,6 mg	0,4 mg
dont protéases	10 mg	2,5 mg

Teneur moyenne en acides aminés					
	Pour 100 g	Pour 25 g	Pour 100 g	Pour 25 g	
Alanine	4,50 g	1,13 g	Méthionine	1,43 g	0,36 g
Arginine	1,56 g	0,39 g	Phénylalanine	2,46 g	0,62 g
Acide aspartique	9,40 g	2,35 g	Proline	5,03 g	1,26 g
Cystéine**	2,07 g	0,52 g	Sérine	3,73 g	0,93 g
Acide glutamique	16,80 g	4,20 g	Thréonine	6,73 g	1,68 g
Glycine	1,40 g	0,35 g	Tryptophane	1,63 g	0,41 g
Histidine	1,54 g	0,39 g	Tyrosine	2,96 g	0,74 g
Isoleucine	5,70 g	1,43 g	Valine	5,00 g	1,25 g
Leucine	9,30 g	2,32 g	BCAA totaux	19,97 g	4,99 g
Lysine	8,26 g	2,07 g			

BEFORE DURING AFTER



HIGH BIOLOGICAL VALUE

LACTOSE FREE

SOURCE OF BCAA

LOW G.I.

Creamy Protein 80

5 NATURAL BLEND + STEVIA*

Mélange exclusif à base de 5 sources naturelles de protéines à différentes vitesses d'absorption, Creamy Protein 80 favorise le maintien de la masse musculaire avec un apport réduit de sucres et de graisses. Cette formule est particulièrement indiquée pour répondre aux besoins en protéines avant ou après l'activité physique. Naturellement riche en acides aminés à chaîne ramifiée, il aide également à prévenir le catabolisme musculaire. Son extraordinaire onctuosité et son haut pouvoir rassasiant en font un allié idéal dans les régimes hypocaloriques. Avec édulcorant naturel (glycosides de stéviol).

- > Protéines de lactosérum concentrées
- > Caséinate de calcium
- > Protéines de lait concentrées
- > Protéines de lactosérum isolées
- > Protéines d'oeuf

ASPARTAME FREE ACESULFAME FREE INSTANTLY SOLUBLE LOW FAT TIME RELEASE
HIGHLY DIGESTIBLE NO SUGAR ADDED GREAT TASTE

code	description	content	box	price
SP919	Creamy Protein 80 Cookies & Cream	500g	1	€ 23,99
SP917	Creamy Protein 80 Exquise Chocolate	500g	1	€ 23,99

Informations nutritionnelles		
	Pour 100 g poussière	Pour 30 g dans 300 ml d'eau
Énergie	1579kJ/372Kcal	474kJ/111kcal
Lipides	3,2 g	0,96 g
dont acides gras saturés	2,50 g	0,75 g
Gluclides	7,90 g	2,37 g
dont sucres	7,00 g	2,1 g
Fibres	--	--
Protéines	78 g	23,4 g
Set	0,60 g	0,18 g
Total Acides aminés à chaîne ramifiée/Total BCAA	16,4 g	4,9 g

Teneur moyenne en acides aminés*

Alanine	3,77 g	1,13 g
Arginine	3,07 g	0,92 g
Acide aspartique	8,52 g	2,55 g
Cystéine**	1,21 g	0,36 g
Acide glutamique	18,97 g	5,69 g
Glycine	1,83 g	0,54 g
Histidine**	2,37 g	0,71 g
Isoleucine**	5,55 g	1,66 g
Leucine**	9,49 g	2,84 g
Lysine**	8,22 g	2,46 g
Méthionine**	2,36 g	0,70 g
Phénylalanine**	4,19 g	1,25 g
Proline	8,50 g	2,55 g
Sérine	5,24 g	1,57 g
Thréonine**	5,07 g	1,52 g
Tryptophane**	1,48 g	0,44 g
Tyrosine**	4,25 g	1,27 g
Valine**	5,95 g	1,78 g

*Rapport à 100 g de protéines
**Acides aminés essentiels Cystéine et tyrosine semi-essentiels

Federica Pellegrini.
Champion olympique de natation
Détenant du record du monde au 200m nage libre

NO
AFTERTASTE

WORLD*1
HIGHEST
PURITY



Teneur moyenne	1 perle (1 gélule)	4 perles (4 gélules)
Huile de poisson	1000 mg	4000 mg
dont		
EPA	559 mg	2234 mg
DHA	229 mg	916 mg
Oméga-3 totaux	819 mg	3276 mg

BEFORE DURING AFTER



Teneur moyenne	Pour 2 cpr (dose maxi/jour)	% VNR* par dose
Magnésium	120,0 mg	32
L-Taurine	76,0 mg	--
Vitamine E	30,0 mg	250
L-glutamine	50,0 mg	--
Zinc	9,0 mg	90
Vitamine B6	3,0 mg	214
Thiamine	2,1 mg	190
Manganèse	5,0 mg	250
Acide pantothénique	6,0 mg	100
Cuivre	1,2 mg	120
Chrome	50,0 mcg	125

Omega 3 Double Plus ++

Omega 3 Double Plus offre une concentration élevée d'acides gras EPA et DHA par gélule et représente l'innovation la plus avancée en matière de recherche et de technologie de production. La Certification IFOS 5 Étoiles garantit un haut degré de pureté de la matière première, sans métaux lourds, sans dioxines ni contaminants, tandis que la Certification de qualité Informed-Sport certifie l'absence de plus de 146 substances dopantes, masquantes et anabolisantes, pour une transparence maximale à l'égard du consommateur.

- > Formule exclusive à haute concentration en Oméga-3
- > 559mg d'EPA et 229mg de DHA par gélule
- > Huile de poisson distillée et purifiée
- > Gélules gastro-résistantes pour une absence totale d'arrière-goût de poisson

GLUTEN FREE LACTOSE FREE NO ADDED SUGAR HIGH CONCENTRATION INNOVATIVE FORMULA



code	description	content	box	price
SP341	OMEGA 3 DOUBLE PLUS ++	240 softgel	1	€ 98,99

AR-Fit Formula + L-TAURINE + L-GLUTAMINE

Complément alimentaire multivitamines et multiminéraux, à base de vitamines C, E, B1, B6, acide pantothénique, L-glutamine, L-aurine, magnésium, manganèse, chrome, cuivre et zinc avec des extraits végétaux de fenugrec, thé vert et éléuthérocoque.

- > La vitamine B6 et le magnésium aident à contrer la fatigue et l'asthénie
- > La vitamine C et le cuivre aident à protéger les cellules du stress oxydatif
- > L'extrait de thé vert a des propriétés antioxydantes connues
- > Formulation enrichie en L-aurine et L-glutamine

WITH VITAMINS WITH MINERALS WITH PLANT EXTRACTS
HIGH CONCENTRATION FAST ACTION

code	description	content	box	price
V107N	AR-Fit Formula	60cpr	1	€ 16,99

Apport en végétaux

	Pour 2 cpr (dose maxi/jour)	% VNR* par dose
Églantier e.s.	136,6 mg	--
Vitamine C apportée	90 mg	112,5
Fenugrec e.s.	100 mg	--
Thé vert e.s.	100 mg	--
Polyphénols apportés	40 mg	--
Caféine apportée	12 mg	--
Éléuthérocoque e.s.	100 mg	--
Éléuthérosides apportés	0,8 mg	--



Vincenzo Nibali
 Équipe cycliste Bahrain-Merida
 Vainqueur du Giro d'Italia 2016
 Vainqueur du Tour de France 2014
 Vainqueur du Giro d'Italia 2013
 Vainqueur de la Vuelta d'Espagne 2010

>
Sels minéraux

100%
 Batch tested:
INFORMED-SPORT
 Trusted by sport

BEFORE DURING AFTER

WITH
 TRIMAGNESIUM
 CITRATE

WITH DIBASIC
 POTASSIUM
 PHOSPHATE

FAST
 ENERGY



+ MAGNÉSIUM + POTASSIUM

Teneur moyenne

	Pour 100 g	Pour 60 g (dose maxi/jour)	% VNR* par dose
Sodium	1,18 g	0,71 g	--
Chlorure	746,00 mg	447,60 mg	56/93,25
Calcium	441,90 mg	265,14 mg	33,14/55,24
Potassium	500,00 mg	300,00 mg	15/25
Magnésium	241,40 mg	144,84 mg	38,62/64,37
Vitamine C	400,00 mg	240,00 mg	300/500
Thiamine	3,3 mg	1,98 mg	180/300
Riboflavine	4,2 mg	2,52 mg	180/300
Niacine	48,00 mg	28,8 mg	180/300
Vitamine B6	4,2 mg	2,52 mg	180/300
Acide folique	600 mcg	360 mcg	180/300
Vitamine B12	7,5 mcg	4,5 mcg	180/300
Biotine	150 mcg	90 mcg	180/300
Acide pantothénique	18 mg	10,80 mg	180/300

* VNR : valeur nutritionnelle de référence pour l'apport quotidien (adultes) selon le Rég. UE 1169/2011

HydraFit

Mélange de glucides, de sels minéraux et de 9 vitamines, conçu pour la préparation d'une solution électrolytique hypotonique (osmolarité 190 mOsm/l), utile pour compenser les pertes hydro-salines dues à la transpiration abondante lors d'une activité physique intense.

- > **Goût rafraîchissant et désaltérant**
- > **Le magnésium et le potassium contribuent à une fonction musculaire normale**
- > **La vitamine C et le magnésium aident à contrer la fatigue et l'asthénie**
- > **Les vitamines C et B6 favorisent le métabolisme énergétique physiologique**

WITH VITAMINS WITH MINERALS GLUTEN FREE
 ASPARTAME FREE ACESULFAME FREE LACTOSE FREE

code	description	content	box	price
SP500_1	HydraFit	400g	1	€ 6,99

Valeurs nutritionnelles moyennes

	Pour 100 g	Pour 60 g (dose maxi/jour)	% VNR* par dose
Énergie	1312,4 kJ/308,8 kcal	787,44 kJ/185,28 kcal	--
Lipides	0 g	0 g	--
dont acides gras saturés	0 g	0 g	--
Glucides	77,20 g	46,32 g	--
dont sucres	53,45 g	32,07 g	--
Fibres	0 g	0 g	--
Protéines	0 g	0 g	--
Sel	2,95 mg	1,77 mg	--



Power inside!



Power inside!



FAST ENERGY

NAMEDSPORT SUPERFOOD

BEFORE DURING AFTER



Isonam Energy

Formulation isotonique (314,24 mOsm/l) à base de maltodextrines, minéraux et vitamines, enrichie en créatine et ginseng. Le magnésium et le potassium contribuent à la fonction musculaire physiologique. Le ginseng a des propriétés tonifiantes et peut être utile en cas de fatigue physique et mentale. La créatine (3g/jour) augmente les performances physiques dans le cadre d'activités d'endurance, de forte intensité et de courte durée. En cas d'activité sportive intense, Isonam Energy est utile parce que:

- > Aide à compenser les pertes hydrosalines dues à la transpiration abondante
- > Les vitamines C et B6 favorisent le métabolisme énergétique et aident à contrer la fatigue et l'asthénie
- > Le magnésium contribue à la fonction musculaire physiologique
- > Formule enrichie avec 3g de créatine et 30mg de ginseng

WITH VITAMINS WITH MINERALS FAST ACTION INSTANTLY SOLUBLE
 ASPARTAME FREE ACESULFAME FREE GLUTEN FREE

code	description	content	box	price
SP13	ISONAM ENERGY Orange	480g	1	€ 16,99
SP12	ISONAM ENERGY Lemon	480g	1	€ 16,99

Teneur moyenne

Sodium	86,67 mg	248 mg	--
Chlore	283,34 mg (35,42 % VNR)	85 mg	10,62
Potassium	486,67 mg (24,34 % VNR)	146 mg	7,3
Magnésium	200 mg (53,34 % VNR)	60 mg	16
Vitamine B6	4,70 mg (335,7% VNR)	1,4 mg	100
Vitamine C	266,67 mg (333 % VNR)	80 mg	100
Créatine	10 g	3 g	--
Ginseng e.s.	100 mg	30 mg	--

* VNR : valeur nutritionnelle de référence pour l'apport quotidien (adultes) selon le Rég. UE 1169/2011

VITAMIN C

VITAMIN B6

FAST ENERGY

Valeurs nutritionnelles moyennes

	Par dose Pour 100 g	maxi/jour (50 g)	% VNR
Energie	1270,2 kJ / 299 kcal	381 kJ / 89,7 kcal	--
Lipides	0,0 g	0,0 g	--
Glucides	74,7 g	22,41 g	--
dont sucres	53,30 g	15,99 g	--
Protéines	0,0 g	0,0 g	--
Sel	2,0 g	0,6 g	--

BEFORE DURING AFTER



4Fuel

4Fuel> est un complément innovant à base de potassium, magnésium, créatine et glutamine. Sa formulation est idéale pour une réintégration saline correcte après l'entraînement. Idéal en cas de fatigue, faiblesse musculaire, crampes, transpiration abondante.

- > Il contribue à une fonction musculaire normale
- > Il aide à contrer la fatigue et l'asthénie
- > Il favorise la récupération physiologique
- > Formule enrichie avec 3g de créatine et 1g de glutamine KyowaQuality®

ASPARTAME FREE ACESULFAME FREE WITH AMINOACIDS GLUTEN FREE
 FAST ABSORPTION WITH MINERALS NO SUGAR ADDED INSTANTLY SOLUBLE

code	description	content	box	price
SP21	4FUEL	20 sachet	1	€ 16,99

VITAMIN C

RECOVERY & HYDRATION



+ MAGNÉSIUM + POTASSIUM
 + CRÉATINE + GLUTAMINE

Teneur moyenne

	Pour 2 sachets (dose maxi/jour)	% VNR**
Magnésium	400 mg	106,7
Potassium	500 mg	25
Créatine	3000 mg	--
Glutamine*	1000 mg	--

* Acides aminés KyowaQuality®
 ** VNR : valeur nutritionnelle de référence pour l'apport quotidien (adultes) selon le Rég. UE 1169/201. Produit inscrit au Registre des suppléments du Ministère italien de la santé, code 54889.

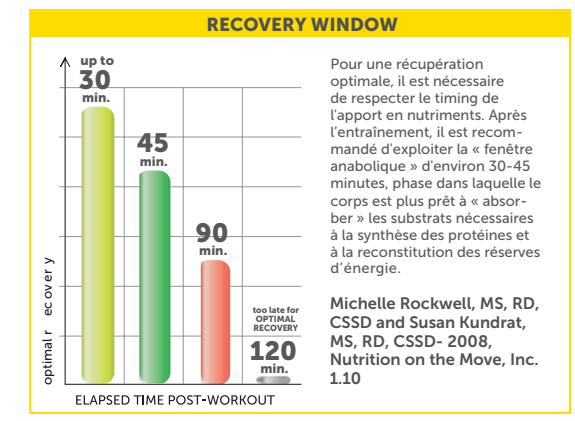

BEFORE DURING AFTER

Acetyl L-Carnitine

Acetyl L-Carnitine est un complément pro-énergétique efficace, à base de L-acétylcarnitine de haute qualité Carnipure™, 100% pure, recommandée lors de performances aérobies ou de forte intensité.

- > Haute pureté
- > Absorption rapide
- > Formulation spéciale en comprimés à haute concentration (1 g/cpr)

LACTOSE FREE GLUTEN FREE INSTANTLY SOLUBLE

code	description	content	box	price
SP332	ACETYL L-CARNITINE	60 cpr	1	€ 27,99



Teneur moyenne

Pour 2 comprimés (dose maxi/jour)

Chlorhydrate de L-acétylcarnitine	1000 mg
-----------------------------------	---------

BEFORE DURING AFTER

Maltonam

Maltonam est un complément énergétique efficace, conçu pour les sportifs, à base de glucides simples et complexes, à différentes vitesses d'assimilation. Sa formulation spéciale est enrichie en carnitine Carnipure®, L-phénylalanine, vitamine C et vitamines du groupe B. En particulier, la vitamine C et les vitamines du groupe B contribuent à un métabolisme énergétique normal.

- > Il offre un mélange de glucides à libération progressive
- > La vitamine C contribue à protéger les cellules du stress oxydatif
- > La vitamine B6 aide à contrer la fatigue et l'asthénie
- > Avec chlorhydrate de carnitine et tartrate Carnipure®
- > 50% Maltodextrines Équivalence en dextrose 19
- > 50% Maltodextrines Équivalence en dextrose 10

WITH VITAMINS LACTOSE FREE INSTANTLY SOLUBLE WITH AMINO ACIDS

code	description	content	box	price
SP82	MALTONAM	500g	1	€ 15,99



Valeurs nutritionnelles moyennes

	Pour 100 g	Par dose maxi/jour (50 g)	% VNR
Énergie	1574,2 kJ/ 370,4 kcal	787,1 kJ/ 185,2 kcal	--
Lipides	0 g	0 g	--
Glucides	92,6 g	46,3 g	--
dont sucres	32,6 g	16,3 g	--
Protéines	0 g	0 g	--
Sel	0,02 g	0,01 g	--

Teneur moyenne

Carnitine	1 g	500 mg	--
L-phénylalanine	800 mg	400 mg	--
Riboflavine	0,84 mg (60 % VNR)	0,42 mg	30
Thiamine	0,66 mg (60 % VNR)	0,33 mg	30
Vitamine B6	0,84 mg (60% VNR)	0,42 mg	30
Vitamine C	1 g (1250% VNR)	500 mg	652

*VNR : valeur nutritionnelle de référence pour l'apport quotidien (adultes) selon le Rég. UE 1169/2011

BEFORE DURING AFTER

Total Energy Shot

Shot énergétique liquide à base de caféine, de guarana et de taurine, enrichi en extrait de sureau et en vitamines C et B12.

- > Action tonifiante et stimulante des composants
- > Idéal au cours de la pratique des sports d'endurance et lors du sprint final
- > La vitamine B12 aide à contrer la fatigue et l'asthénie
- > La vitamine C contribue à un métabolisme énergétique normal
- > Le guarana apporte un soutien énergétique
- > Formulation enrichie en taurine et caféine

INSTANT ACTION GLUTEN FREE LACTOSE FREE NO SUGAR ADDED HIGH CONCENTRATION

code	description	content	box	price
SP151	TOTAL ENERGY SHOT Orange	60ml	50	€ 2,70

Teneur moyenne

Par dose maxi/jour (1 flacon)

Vitamine C	180 mg (225 %*)
Niacine	36 mg (225 %*)
Vitamine B12	2,5 mcg (100 %*)
Magnésium	225 mg (60%*)
Caféine	130 mg
Taurine	1000 mg
Guarana e.s.	100 mg
Apport en caféine	50 mg
Sureau noir e.s.	120 mg
Apport en polyphénols	14,4 mg
Apport en anthocyanes	10,4 mg

* VNR : valeur nutritionnelle de référence pour l'apport quotidien (adultes) selon le Rég. UE 1169/2011



Valeurs nutritionnelles moyennes

Par dose maxi/jour (1 flacon)

Énergie	206 KJ/48,6 Kcal
Lipides	0 g
dont acides gras saturés	0 g
Glucides	12 g
dont sucres	12 g
Fibres	0 g
Protéines	0 g
Sel	0,037 g

BEFORE DURING AFTER

Total Energy Rush

Comprimés à haute concentration de taurine, caféine et niacine, enrichis en extraits végétaux de guarana et de jiaogulan. La niacine est utile pour favoriser le métabolisme énergétique, tandis que le guarana agit comme un tonique et aide à contrer la fatigue et l'asthénie; l'extrait de jiaogulan est utile pour favoriser le métabolisme des glucides et des lipides.

- > Idéal pour les sports d'endurance et lors des activités sportives de forte intensité
- > Utile à prendre avant l'entraînement
- > Avec des extraits végétaux sélectionnés de guarana et jiaogulan
- > Les vitamines du groupe B contribuent aux fonctions psychophysiques et au métabolisme énergétique
- > Formulation enrichie en taurine et caféine

FAST ABSORPTION GLUTEN FREE LACTOSE FREE

code	description	content	box	price
SP830	TOTAL ENERGY RUSH	60 cpr	1	€ 16,99

Teneur moyenne

Pour 1 cpr (dose maxi/jour)

		% VNR
Taurine	500 mg	--
Caféine anhydre	120 mg	--
Jiaogulan e.s.	100 mg	--
apport en gypenosides	80 mg	--
Guarana e.s.	100 mg	--
apport en caféine	10 mg	--
Niacine	16 mg	100

* VNR : valeur nutritionnelle de référence pour l'apport quotidien (adultes) selon le Rég. UE 1169/2011



EXTRA STRONG

HIGH CAFFEINE CONTENT

FAST ENERGY

HIGH IN CAFFEINE

EXTRA STRONG

100% PURE ACETYL L-CARNITINE

FAST ENERGY

VITAMIN C

FAST ENERGY

TIME RELEASE



Gel



Fabio Aru
Champion d'Italie 2017
Vainqueur de la Vuelta d'Espagne 2015

BEFORE DURING AFTER



Total Energy Fruit Jelly

Gelée énergétique savoureuse à base de glucides et de vrais fruits, enrichie en sels minéraux. Idéale comme en-cas avant et pendant l'entraînement.

- > Avec de vrais fruits (72%)
- > Glucides à différentes vitesses d'assimilation
- > Le magnésium contribue à une bonne fonction musculaire
- > Ne contient pas de graisses

FAST ACTION WITH MINERALS GLUTEN FREE
FAT FREE VEGAN FRIENDLY

code	description	content	box	price
SP112	Total Energy Fruit Jelly Peach Orange & Lemon	42g	28	€ 2,00

Teneur moyenne	Pour 100 g	Pour 2 paquets/jour (80 ml)
Sodium	2,3 mg	1,9 mg
Magnésium	67,1 mg	56,4 mg (15 % VNR*)

* VNR : valeur nutritionnelle de référence pour l'apport quotidien (adultes) selon le Rég. UE 1169/2011

Valeurs nutritionnelles moyennes	Pour 100 g	Pour 2 paquets/jour (80 ml)
Énergie	730 kJ/ 172 kcal	613 kJ/ 144 kcal
Lipides	0 g	0 g
dont ac. gras saturés	0 g	0 g
Glucides	41 g	35 g
dont sucres	41 g	35 g
Fibres	2,3 g	1,9 g
Protéines	0,50 g	41 g
Sel	>0,01 g	<0,01 g

FAST ENERGY

PRO ENDURANCE

BEFORE DURING AFTER



Valeurs nutritionnelles moyennes	Pour 100 ml	Pour 2 paquets/jour (80 ml)
Énergie	1294 kJ/304 kcal	1035 kJ/244 kcal
Lipides	0 g	0 g
dont ac. gras saturés	0 g	0 g
Glucides	76 g	61 g
dont sucres	33 g	27 g
Fibres	0 g	0 g
Protéines	0 g	0 g
Sel	0,34 g	0,27 g

Total Energy Carbo Gel

Gel énergétique à base de maltodextrines à différentes vitesses d'assimilation: (D.E. : 9,19) dextrose, fructose, enrichi en sels minéraux.

- > Maltodextrines à libération progressive (D.E. : 9,19)
- > Particulièrement utile dans les sports d'endurance
- > Idéal avant et pendant l'entraînement
- > Favorise un regain rapide d'énergie
- > Formulation enrichie en taurine et caféine

FAST ABSORPTION TIME RELEASED
NATURAL FLAVOURS VEGAN FRIENDLY
GLUTEN FREE GREAT TASTE

code	description	content	box	price
SP8381	TOTAL ENERGY CARBO GEL Agrumix	40ml	24	€ 2,00

BEFORE DURING AFTER



Valeurs nutritionnelles moyennes	Pour 100 ml	Pour un sachet/jour (40 ml)
Énergie	1267 kJ/298 kcal	507 kJ/119 kcal
Lipides	0 g	0 g
dont ac. gras saturés	0 g	0 g
Glucides	74 g	30 g
dont sucres	31 g	13 g
Fibres	0 g	0 g
Protéines	0 g	0 g
Sel	0,34 g	0,14 g

Total Energy Strong Gel

Gel énergétique à base de maltodextrines à différentes vitesses d'assimilation: (D.E. : 9,19) enrichi en caféine, taurine et guarana.

- > Action énergisante efficace
- > Maltodextrines à différente D.E.
- > Favorise un regain rapide d'énergie
- > Idéal pendant l'entraînement
- > Recommandé lors des sprints et, notamment, avant la ligne d'arrivée

FAST ENERGY GREAT TASTE TIME RELEASED VEGAN FRIENDLY
WITH CAFFEINE WITH PLANT EXTRACTS GLUTEN FREE

code	description	content	box	price
SP8391	TOTAL ENERGY STRONG GEL Lemon	40ml	24	€ 2,00

Teneur moyenne	Pour un sachet (dose maxi/jour) 40 ml
L-taurine	400 mg
Guarana e.s. tit. à 10 % en caféine	154 mg
dont caféine	15,4 mg
Caféine	50 mg

BEFORE DURING AFTER



Total Energy Hydra Gel

Gel énergétique à base de maltodextrines à libération progressive, palatinose™ (à faible index glycémique) et Vitargo®, enrichi en sels minéraux pour fournir à l'athlète une énergie constante et graduelle. Avec de la vitamine C pour contrer la fatigue et l'asthénie pendant les sports d'endurance.

- > Avec isomaltulose palatinose™ à faible index glycémique
- > Avec sels minéraux et glucides à différentes vitesses d'assimilation
- > Avec de la vitamine C pour faciliter l'absorption du fer et favoriser le métabolisme énergétique
- > Le magnésium, le calcium et le potassium favorisent la fonction musculaire
- > Idéal avant et pendant l'entraînement

WITH MINERALS WITH VITAMIN C VEGAN FRIENDLY
GLUTEN FREE GREAT TASTE

code	description	content	box	price
SP9371	TOTAL ENERGY HYDRA GEL Lemon & Peach	50ml	32	€ 2,20

Teneur moyenne

	Par dose/jour (2x 50 ml)	%VNR
Potassium	300 mg	15
Calcium	120 mg	15
Magnésium	56,3 mg	15
Fer	2,1 mg	15
Vitamine C	120 mg	150

* VNR= valeur nutritionnelle de référence pour l'apport quotidien (adultes) selon le Rêg. UE 1169/2011

FAST ENERGY

PRO ENDURANCE

Valeurs nutritionnelles moyennes

	Pour 100 ml	Par dose/jour (2x 50 ml)
Énergie	900 kJ/212 kcal	900 kJ/212 kcal
Lipides	-	-
dont acides gras saturés	-	-
Glucides	-	-
dont sucres	28 g	28 g
Fibres	-	-
Protéines	-	-
Sel	-	-

BEFORE DURING AFTER



Total Energy Amino Gel

Gel énergétique à base de maltodextrines à libération progressive, fructose, Vitargo® et isomaltulose palatinose™ (à faible index glycémique), qui apporte de l'énergie, sous forme de glucose, de façon constante et prolongée. Sa formule spéciale est enrichie en acides aminés à chaîne ramifiée Ajipure®. Les acides aminés glucoformateurs alanine et glycine jouent un rôle énergétique, en intervenant dans la synthèse du glucose.

- > Avec isomaltulose palatinose™ à faible index glycémique
- > Fournit une énergie constante et progressive
- > Apporte un soutien énergétique lors des exercices d'endurance
- > Avec acides aminés Ajipure®
- > Idéal avant et pendant l'entraînement dans les sports d'endurance

WITH AMINO ACIDS GLUTEN FREE
WITH BCAA VEGAN FRIENDLY GREAT TASTE

code	description	content	box	price
SP9361	TOTAL ENERGY AMINO GEL Orange Flavour	50ml	32	€ 2,20

Teneur moyenne

	Par dose/jour (2x 50 ml)	%VNR
L-leucine	620 mg	
L-isoleucine	310 mg	
L-valine	310 mg	
β-alanine	300 mg	

* VNR= valeur nutritionnelle de référence pour l'apport quotidien (adultes) selon le Rêg. UE 1169/2011

FAST ENERGY

PRO ENDURANCE

Valeurs nutritionnelles moyennes

	Pour 100 ml	Par dose/jour (2x 50 ml)
Énergie	862 kJ/203 kcal	862 kJ/203 kcal
Lipides	-	-
dont acides gras saturés	-	-
Glucides	49 g	49 g
dont sucres	32 g	32 g
Fibres	<0,5 g	<0,5 g
Protéines	-	-
Sel	-	-

BEFORE DURING AFTER



FAST ENERGY

PRO ENDURANCE

Sport Gel



Gels énergétiques à base de glucides simples et complexes à libération progressive, avec D-ribose et isomaltulose Palatinose™ (à faible index glycémique), qui fournissent une énergie constante et progressive. Proposés dans quatre goûts rafraîchissants, avec l'ajout d'ingrédients spécifiques pour soutenir toutes les phases de l'entraînement.

- > Avec isomaltulose palatinose™ à faible index glycémique
- > Maltodextrines à différente D.E.
- > Fournit de l'énergie de manière instantanée et durable
- > Particulièrement indiqué pour les sports d'endurance
- > Idéal avant et pendant l'entraînement
- > Ne contient pas de graisses

GLUTEN FREE NO FAT GREAT TASTE
TIME RELEASED VEGAN FRIENDLY

code	description	content	box	price
SP9402	SPORT GEL Cola Lime	25ml	15	€ 1,60
SP9391	SPORT GEL Lemon Ice Tea	25ml	15	€ 1,60
SP9381	SPORT GEL Orange	25ml	15	€ 1,60
SP9401	SPORT GEL Tropical	25ml	15	€ 1,60

> Glucogenic Formula – Goût Lemon Ice Tea

Avec les acides aminés glucoformateurs glycine et L-alanine de la plus pure qualité Ajipure® qui interviennent dans la synthèse du glucose, jouant un rôle énergétique.

>> 5 CARB MATRIX >> WITH L-ALANINE >> WITH GLYCINE

Valeurs nutritionnelles moyennes

	Pour 100 ml	Par dose journalière (25 ml)
Énergie	1190 kJ/ 280 kcal	297 kJ/ 70 kcal
Lipides	0 g	0 g
dont ac. gras saturés	0 g	0 g
Glucides	70 g	17 g
dont sucres	45 g	11 g
Fibres	0 g	0 g
Protéines	0 g	0 g
Sel	0,26 g	0,07 g

Teneur moyenne : Pour 100 ml / 25 ml (dose journalière)
Glycine : 2,0 g / 0,5 g, L-alanine : 2,0 g / 0,5 g - * Equivalent à 0 car seuls les acides aminés libres sont présents.

> Hydration Formula – Goût Tropical

Avec l'ajout de magnésium et de potassium pour favoriser la fonction musculaire pendant l'entraînement.

>> WITH MAGNESIUM >> WITH POTASSIUM >> 5 CARB MATRIX

Valeurs nutritionnelles moyennes

	Pour 100 ml	Par dose journalière (25 ml)
Énergie	1180 kJ/ 278 kcal	295 kJ/ 69 kcal
Lipides	0 g	0 g
dont ac. gras saturés	0 g	0 g
Glucides	68,9 g	17,2 g
dont sucres	44,7 g	11,2 g
Fibres	0 g	0 g
Protéines	0 g	0 g
Sel	0,26 g	0,06 g
Potassium	1200 mg	300 mg
	(60 % VNR**)	(15 % VNR**)
Magnésium	225 mg	56,25 mg
	(60 % VNR**)	(15 % VNR**)

**VNR : Valeur nutritionnelle de référence pour l'apport quotidien (adultes) - Rêg. UE 1169/2011.

>> 5 CARB MATRIX >> WITH CAFFEINE >> DOUBLE POWER

Valeurs nutritionnelles moyennes

	Pour 100 ml	Par dose journalière (25 ml)
Énergie	1177 kJ/ 277 kcal	294 kJ/ 69 kcal
Lipides	0 g	0 g
dont ac. gras saturés	0 g	0 g
Glucides	68,9 g	17,2 g
dont sucres	44,7 g	11,2 g
Fibres	0 g	0 g
Protéines	0 g	0 g
Sel	0,27 g	0,07 g

Teneur moyenne : Pour 100 ml / 25 ml (dose journalière)
Caféine : 200 mg / 50 mg.

> Pure Energy Formula – Goût Orange

Avec 5 glucides à différentes vitesses d'absorption, pour apporter de l'énergie à l'athlète de manière constante et progressive.

>> ISOTONIC ENERGY >> 5 CARB MATRIX >> NO CAFFEINE

Valeurs nutritionnelles moyennes

	Pour 100 ml	Par dose journalière (25 ml)
Énergie	1184 kJ/ 278 kcal	396 kJ/ 70 kcal
Lipides	0 g	0 g
dont ac. gras saturés	0 g	0 g
Glucides	68,9 g	17,2 g
dont sucres	44,7 g	11,2 g
Fibres	0 g	0 g
Protéines	0 g	0 g
Sel	0,26 g	0,06 g



Shots

280 mg

VITAMIN B6

FAST ENERGY

BEFORE DURING AFTER



Informations nutritionnelles

	Par dose maxi/jour (25 ml)	* % VNR
Vitamine B6	1,4 mg	100
Magnésium	280 mg	100

* VNR : valeur nutritionnelle de référence pour l'apport quotidien (adultes) selon le Règ. UE 1169/2011

Magnesium Liquid + Vitamin B6

Chaque ampoule de Magnesium Liquid contient 280mg de magnésium et 1,4mg de vitamine B6. Sa consommation est particulièrement indiquée après l'entraînement et pendant la phase de récupération. Le magnésium est un minéral essentiel, très important pour la santé de l'organisme : il aide à contrer la fatigue et l'asthénie et favorise la fonction musculaire ; il contribue à la synthèse des protéines et au fonctionnement du système nerveux. La vitamine B6 contribue au métabolisme normal des protéines et du glycogène.

- > **Concentré liquide en ampoule monodose**
- > **280mg de magnésium par ampoule**
- > **Enrichi en vitamine B6**
- > **Il aide à réduire la sensation de fatigue**
- > **Il contribue à une fonction musculaire normale**

FAST ABSORPTION | GLUTEN FREE | WITH VITAMINS
HIGH CONCENTRATION | LACTOSE FREE | WITH MINERALS

FORMULE STRONG
+ MAGNÉSIUM
+ VITAMINE B6

code	description	content	box	price
SP291	MAGNESIUM LIQUID + VITAMIN B6	25ml	20	€ 1,50

BEFORE DURING AFTER



Teneur moyenne

	Par dose maxi/jour (25 ml)	* % VNR
Magnésium	225 mg	60
Vitamine C	160 mg	200
Acide pantothénique	1,8 mg	30
Vitamine B6	0,42 mg	30
Vitamine B1	0,33 mg	30
Guarana e.s.	2000 mg	-
Apport en caféine	200 mg	-

* VNR : valeur nutritionnelle de référence pour l'apport quotidien (adultes) selon le Règ. UE 1169/2011

Guaranà Super Strong Liquid

Shot à action énergisante, à base de guarana, magnésium et vitamines, particulièrement utile dans la pratique des sports d'endurance. Le guarana exerce un effet tonifiant et énergisant ; le magnésium favorise la fonction musculaire normale, la synthèse des protéines et, combiné à la vitamine B6, aide à contrer la fatigue et l'asthénie. La vitamine C aide à protéger les cellules contre le stress oxydatif et l'acide pantothénique favorise la performance mentale.

- > **2000mg d'extrait de guarana par shot**
- > **Apport élevé en caféine : 200mg**
- > **Idéal avant l'entraînement ou lors des sprints**
- > **Enrichi en vitamine B1 et B6**
- > **Avec vitamine C, antioxydante**

FAST ABSORPTION | GLUTEN FREE | WITH VITAMINS
HIGH CONCENTRATION | LACTOSE FREE | WITH MINERALS
WITH PLANT EXTRACTS | WITH CAFFEINE

+ GUARANA
+ MAGNÉSIUM
+ VITAMINES

code	description	content	box	price
SP271	GUARANÀ SUPER STRONG LIQUID	fiala 20ml	20	€ 2,60

25
M. VIÑALES



SPA



MOVISTAR YAMAHA
MotoGP

46
V. ROSSI



ITA



MOVISTAR YAMAHA
MotoGP



movistar



YAMAHA
FACTORY RACING

**OFFICIAL
SUPPLIER**
MotoGP Team 2018

A4 SALES AGENTS

ITALIA

LOMBARDIA / PIEMONTE / VALLE D'AOSTA / LIGURIA

Lorenzo Galimberti

M +39 335 8178672

T +39 02 49469659

l.galimberti@libero.it

info@galimbertirappresentanze.it

VENETO / TRENTO ALTO ADIGE / FRIULI VENEZIA GIULIA

Alberto Buratti

M +39 320 3159551

alberto.buratti@gmail.com

EMILIA ROMAGNA

Luca Molinari

M +39 347 2912879

lucamolinari1979@gmail.com

TOSCANA

Marco Mazzoni

M +39 393 9889394

marco.mazzoni2@gmail.com

LAZIO / MARCHE / UMBRIA / ABRUZZO / MOLISE

Nicola Di Luzio

M +39 347 7805320

nicola.diluzio@gmail.com

CAMPANIA / PUGLIA / BASILICATA / CALABRIA

Pasquale Pegna

M +39 339 2058455

pegna77@gmail.com

Luigi Pegna

M +39 348 1951264

pegna.rappresentanze@gmail.com

SICILIA

Giuseppe Calvaruso

M +39 388 3480893

giuseppecalvaruso1@gmail.com

SARDEGNA

Stefano Mocchi

M +39 392 7427909

rappresentanze.stefanomocchi@gmail.com

FRANCE

REGION NORD

HAUT DE FRANCE / ILE DE FRANCE / HAUTE NORMANDIE /
CHAMPAGNE ARDENNES

Max Vanovershelde

+33 662121870

maxvano@free.fr

REGION OUEST

BRETAGNE / BASSE NORMANDIE / PAYS DE LOIRE / CENTRE /
POITOUX CHARENTES

Gilles Cosperec

+33 668698366

gsports@hotmail.fr

REGION SUD OUEST

AQUITAINE / MIDI PYRENNÉES / LANGUEDOC ROUSSILLON /
LIMOUSIN

Raphael Robert

+33 618008182

rafibikes@gmail.com

REGION SUD EST

PROVENCE ALPES CÔTE D'AZUR / CORSE / RHÔNE ALPES /
AUVERGNE

Pierre Bajoux

+33 699321434

pierrebajoux@gmail.com

REGION EST

ALSACE / LORRAINE / FRANCHE COMTÉ / BOUGOGNE

Patrick Ledys

+33 607140471

p.ledys@alecar-sports.com

RESPONSABLE COMMERCIAL FRANCE

Terigi Synowiec

+33 607708217

t.synowiec@a4selection.com

SELLE ROYAL
SELLEROYAL.COM

PEdAL ED
PEDALED.COM

fi'zi:k
FIZIK.COM

 crankbrothers
CRANKBROTHERS.COM

Continental 
CONTINENTAL-TIRES.COM

NAMEDSPORT.COM

Responsible Commercial France: Terigi Synowiec · t.synowiec@a4selection.com · Tel. +33 607708217

Pour toute réclamation écrire à: **info@a4selection.com**

Service Après Vente Crankbrothers France/Italie: PippoWheels srl
Via S. Venier, 15 · 36100 Vicenza IT · Tel. +39 0444 532052 · service@pippowheels.com

Copyright. Tutti i contenuti del presente catalogo, inclusi testi, documenti, loghi, immagini, grafici, video, la loro stessa disposizione e adattamento all'interno del sito, sono tutelati dalle leggi sul Copyright® di Selle Royal S.p.A. e dagli altri diritti di proprietà intellettuale. La riproduzione, alterazione, modifica, pubblicazione e uso, anche parziale, di questi contenuti per qualsiasi scopo, sia esso commerciale o meno, in qualsiasi formato e supporto, non sono permessi senza l'espressa autorizzazione scritta da parte di Selle Royal S.p.A. Tutti i diritti sono riservati.

Marchi. Tutti i marchi e i loghi presenti nel catalogo sono proprietà esclusiva dei rispettivi titolari. Qualsiasi uso e/o riproduzione degli stessi per qualunque scopo o mezzo è espressamente e severamente vietato e verrà perseguito dalle leggi competenti in materia.

Limiti di responsabilità. I contenuti e le informazioni presenti nel catalogo sono fornite "così come sono" e periodicamente aggiornate e controllate. Conseguentemente, potrebbero non risultare complete, accurate o aggiornate in ogni momento, o contenere degli errori. Selle Royal S.p.A. declina ogni responsabilità ed ogni garanzia riguardante la completezza, l'aggiornamento, errori ed omissioni delle informazioni e dei contenuti presenti nel catalogo.

Copyright. Tous les contenus du présent catalogue, y compris les textes, documents, logos, images, graphiques, vidéos, leur propre disposition et adaptation à l'intérieur du site, sont protégés suivant les lois du Copyright® de Selle Royal S.p.A et des autres droits de la propriété intellectuelle. La reproduction, altération, modification, publication et l'utilisation, même partielle de ces contenus, quel qu'en soit l'usage, soit commercial ou non, dans tout type de format et support, ne sont pas permis sans l'autorisation expresse écrite de Selle Royal S.p.A. Tous les droits sont réservés.

Marques. Toutes les marques et logos présents dans le catalogue sont la propriété exclusive de leurs détenteurs respectifs. Toute utilisation et/ou reproduction de ceux-ci pour n'importe quel but ou moyen sont strictement et sévèrement interdits et entraîneront des poursuites suivant les lois applicables en la matière.

Limites de responsabilité. Les contenus et les informations présents dans le catalogue sont fournis "en l'état" et périodiquement mis à jour et contrôlés. En conséquence, ils pourraient s'avérer incomplets, imprécis ou mis à jour à tout moment, ou contenir des erreurs. Selle Royal S.p.A décline toute responsabilité et toute garantie concernant l'exactitude, la mise à jour, erreurs et omissions des informations et des contenus présents dans le catalogue.

SELECTION

C/O SELLE ROYAL SpA

Via Vittorio Emanuele, 119 · 36050 Pozzoleone (VI) Italy
Tel. +39 0444 461100 / +39 0444 461102 / +39 0444 461148 · Fax. +39 0444 462025
info@a4selection.com · www.a4selection.com

Les articles présentés dans ce catalogue sont couverts par 2 années de garantie à compter de la date d'achat.

SELECTION

