



# SELECTION

WORKBOOK 2019



A SELECTION OF THE BEST  
CYCLING ACCESSORIES AVAILABLE



PEDAL ED

fi'zi:k



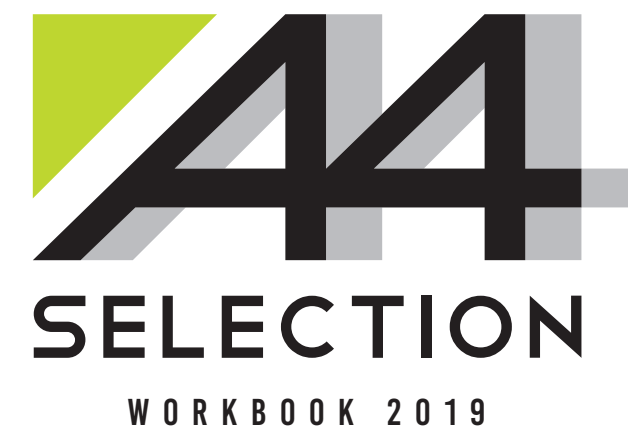

**SELLE ROYAL 2**  
**PEDALED 46**  
**FI'ZI:K 110**  
**CRANKBROTHERS 180**  
**CONTINENTAL 240**  
**NAMEDSPORT 288**





## **SELLE ROYAL SCIENTIA FOR CYCLISTS**

---

The scientific range of saddles, developed in collaboration with the University of Cologne.

Die wissenschaftliche Kollektion an Sätteln, entwickelt in Zusammenarbeit mit der Deutschen Sporthochschule Köln.

Page 4

## **SELLE ROYAL COMFORT FOR CYCLISTS**

---

A range with lines developed for every type of Riding Position from Athletic to Relaxed.

Die unterschiedlichen Kategorien innerhalb dieser Kollektion wurden entwickelt, um den verschiedenen Sitzposition von Athletic bis hin zu Relaxed gerecht zu werden.

Page 14

# SELLE ROYAL SCIENTIA FOR CYCLISTS

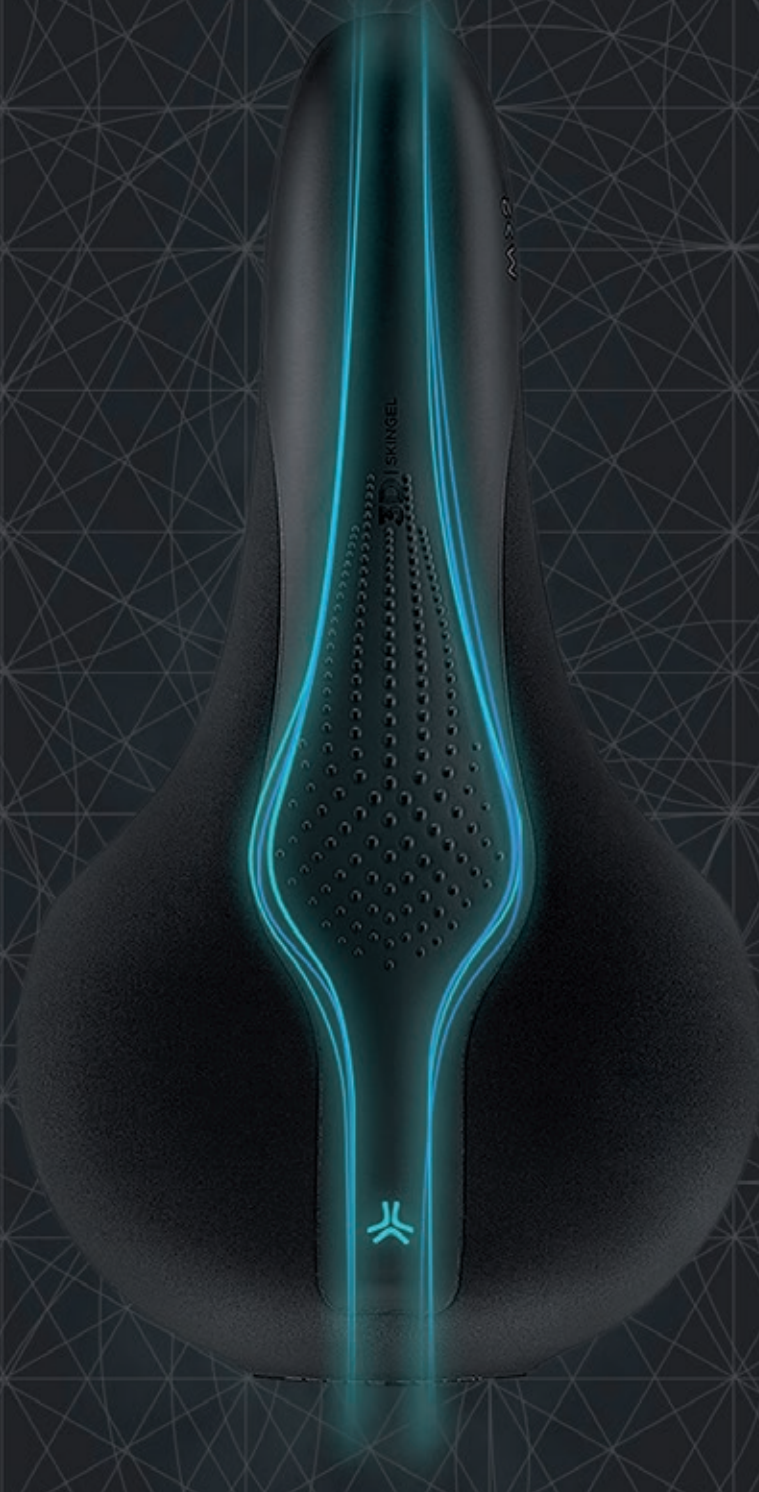

Scientifically developed in collaboration with



**Deutsche  
Sporthochschule Köln**  
German Sport University Cologne

## SCIENTIA FEATURES

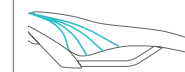

### BODY CONTOUR

A radius-specific design to provide optimum comfort for differing spine angles. The more inclined the Riding Position, the smaller the edge-radius.

Ein Radius-spezifisches Design, das unterschiedlichen Wirbelsäulenwinkeln optimalen Komfort bietet. Je gestreckter die Sitzposition, desto geringer der Radius der Flanke.



### REAR PLATEAU

An elevated rear section to prevent backward sliding and decrease pressure in the saddle middle which can cause discomfort.

Ein erhöhter Heckbereich, der vor Verrutschen nach hinten schützt und den Druck in der Mitte des Sattels, dem Auflageort des Dammbereichs, verringert, um Beschwerden vorzubeugen.

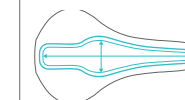

### CENTRAL RESERVOIR

Indentation in the saddle middle whose shape and dimensions have been studied to correspond to ischial variations for greater comfort.

Eine Vertiefung in der Sattelmittle, deren Form und Größe mit den Sitzknochenabständen korrespondieren - für größeren Komfort.

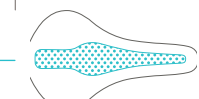
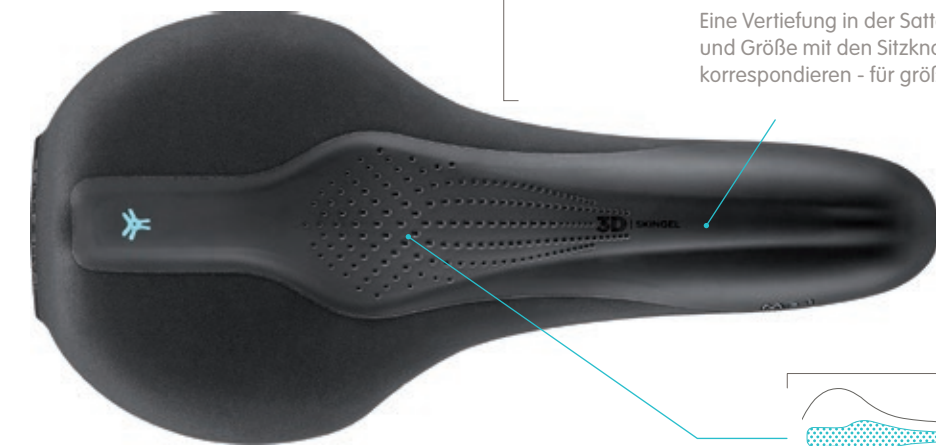

### 3D SKINGEL

Royalgel™ is placed intelligently at critical points of contact on the saddle surface for added shock absorption, while reducing overall saddle weight.

Royalgel™ wurde an den kritischen Kontaktpunkten der Satteloberfläche verbaut, für eine erhöhte Dämpfung bei gleichzeitiger Gewichtsreduzierung des Sattels.



### CURVA SUSPENSION

The unique curved suspension design is attached at the rear of the base to offer exclusive comfort by avoiding pressure on the seat bone contact points and guaranteeing additional lateral flexibility.

Die einteilige gebogene Sattelstrebe dämpft insbesondere den Bereich der Sitzknochen und bietet daher ein spürbares Mehr an Komfort.



# MEASUREMENT STEPS

## 1 FIND YOUR RIDING POSITION BESTIMMEN SIE IHRE SITZPOSITION

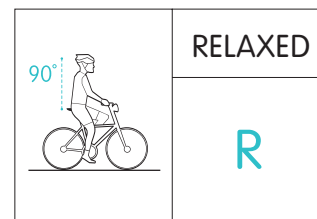
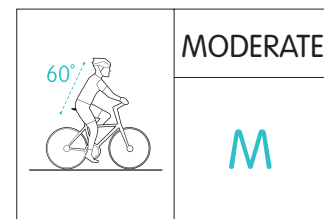
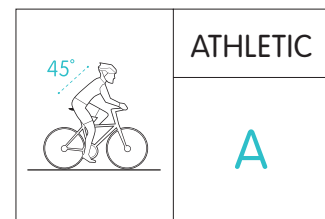

## 2 DETERMINE YOUR ISCHIAL VARIATION VERMESSEN SIE IHREN SITZKNOCHENABSTAND

Reset the gel pad.  
Glätten Sie das Gelkissen.

Sit at 90° and apply pressure.  
Setzen Sie sich mit senkrechtem Rücken darauf und belasten Sie die Sitzfläche.

Find the centres of the two ischial impressions and add together the two numbers. The result is your ischial distance.

Ermitteln Sie die Zentren der zwei Sitzknochenabdrücke und addieren Sie die zwei Zahlen. Das Ergebnis ist Ihr Sitzknochenabstand.

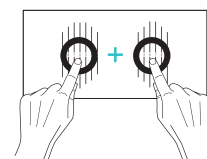
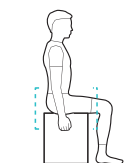
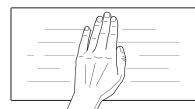

Example/Beispiel:  
5cm+7cm=12cm

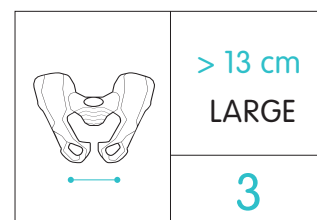
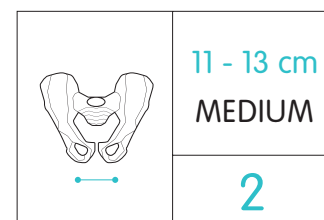
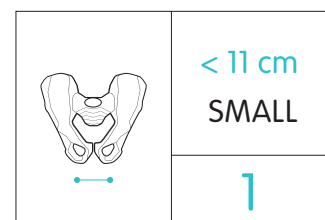

# THE RANGE

	1 SMALL	2 MEDIUM	3 LARGE
ATHLETIC A	 A>1	 A>2	 A>3
MODERATE M	 M>1	 M>2	 M>3
RELAXED R	 R>1	 R>2	 R>3

**SCIENTIA A1 / SMALL**  
**code** 54A0SB0A09210  
**sizes** L 289 mm / W 127 mm / W 380 g  
**price** € 79,90

UNISEX



A>1

**SCIENTIA A2 / MEDIUM**  
**code** 54A0MB0A09210  
**sizes** L 289 mm / W 144 mm / W 390 g  
**price** € 79,90

UNISEX



A>2

**SCIENTIA A3 / LARGE**  
**code** 54A0LB0A09210  
**sizes** L 289 mm / W 159 mm / W 415 g  
**price** € 79,90

UNISEX



A>3

**SCIENTIA M1 / SMALL**  
**code** 54M0SB0A09210  
**sizes** L 289 mm / W 141 mm / W 425 g  
**price** € 79,90

UNISEX



M>1

**SCIENTIA M2 / MEDIUM**  
**code** 54M0MB0A09210  
**sizes** L 289 mm / W 161 mm / W 455 g  
**price** € 79,90

UNISEX



M>2

**SCIENTIA M3 / LARGE**  
**code** 54M0LB0A09210  
**sizes** L 289 mm / W 178 mm / W 465 g  
**price** € 79,90

UNISEX



M>3

# SCIENTIA TESTED ON THOUSANDS, DESIGNED ON YOU.

**SCIENTIA R1 / SMALL**

code 54R0SB0A09210

sizes L 289 mm / W 169 mm / W 479 g

price € 79,90

UNISEX



R>1

**SCIENTIA R2 / MEDIUM**

code 54R0MB0A09210

sizes L 289 mm / W 196 mm / W 485 g

price € 79,90

UNISEX



R>2

**SCIENTIA R3 / LARGE**

code 54R0LB0A09210

sizes L 289 mm / W 224 mm / W 520 g

price € 79,90

UNISEX



R>3



in collaboration with



# POP MATERIALS

## MEASURING TOOLS

(sold separately)  
(einzeln erhältlich)

### MEASURING TOOL STANDARD

High-quality metal stool with gel pad, consumer brochures included.  
Hochwertiger Metallhocker mit Gelaufage, Broschüren für Kunden sind enthalten.

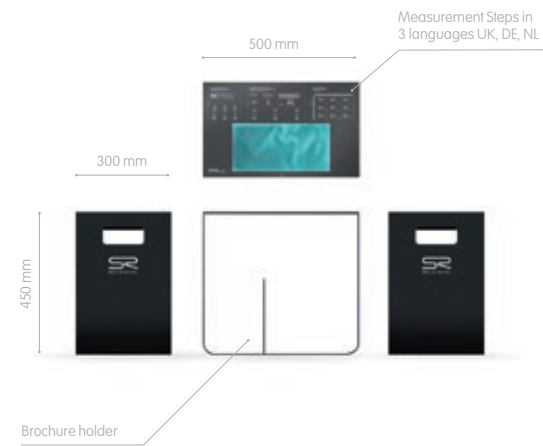

CODE: SRSIMTOA00000

### PORTABLE MEASURING TOOL

Ultra light tool in PS with gel pad.  
Ultraleichtes Werkzeug mit Gelpad.



CODE: SRSIMTOA10000

## ADVANCED KIT SLIM

**NEW**

Compact display in MDF and Dibond®, pre-filled and ready for sale with 9 saddles, 1 for each model.

+ 9 re-fill saddles, 1 for each model. + Portable Measuring Tool.

Verkaufsbereiter Aufsteller aus MDF und Dibond® mit 9 Sätteln bestückt, einen je Modell.

+ 9 Nachfüllsättel, einen je Modell. + Portable Measuring Tool.



CODE: SRSIADVA10000

# POP MATERIALS

## ADVANCED KIT

Metal display pre-filled with 27 saddles, 3 for each model, ready for sale. + Measuring Tool standard.  
Metall-Display Bestückt mit 27 Sätteln, 3 je Modell, verkaufsfertig. + Measuring Tool standard.



CODE: SRSIADVA00000

## FLEX KIT

(Selling unit is only 2 Modules)  
(VE nur 2 Module)

### EACH MODULE

Plastic frame with metal hooks slatwall/tegometall compatible, pre-filled with 6 saddles, 2 for each model, ready for sale.

> Measuring Tools sold separately.

Kunststoffrahmen mit Metallhaken, kompatibel mit slatwall oder tegometall. Mit 6 Sätteln bestückt, 2 für jedes Modell, verkaufsfertig.

> Measuring Tools einzeln erhältlich.



Order each module individually from among these codes:

Athletic Module  
CODE: SRSIATHA00000

Moderate Module  
CODE: SRSIMODA00000

Relaxed Module  
CODE: SRSIRELA00000



## SELLE ROYAL COMFORT FOR CYCLISTS

Selle Royal has categorized 3 riding positions to address some important contact areas: Athletic, Moderate and Relaxed.

Riding position naturally has the most influence on how the sit bones and other intimate parts of the body contact the saddle. It's these contact points that must be addressed with specific saddle designs.

Selle Royal hat unter Berücksichtigung wichtiger Berührungszonen 3 verschiedene Sitzpositionen definiert: Athletic, Moderate und Relaxed.

Die Sitzposition hat für gewöhnlich den größten Einfluss an welcher Stelle unsere Sitzknochen und Extremitäten den Sattel berühren. Für exakt diese Kontaktpunkte wurden spezifische Satteldesigns entwickelt.

### RIDING POSITIONS

#### ATHLETIC 45°

The Athletic rider typically sits on the saddle with a 45-degree spine angle. This more upright position moves the weight distribution and sit bone area farther back on a saddle.

Der Athletic-Fahrer sitzt in der Regel mit einem Wirbelsäulenwinkel von 45 Grad auf dem Sattel. Diese leicht aufrechte Sitzposition verlagert die Gewichtsverteilung und die Druckzone der Sitzknochen auf dem Sattel nach hinten.



#### MODERATE 60°

The Moderate rider typically sits on the saddle with a 60-degree spine angle. This position continues to move the rider's weight and sit bones farther back on a wider saddle.

Der Moderate-Fahrer sitzt in der Regel mit einem Wirbelsäulenwinkel von 60 Grad auf dem Sattel. In dieser Position werden das Fahrergewicht und die Druckzone der Sitzknochen auf einem breiteren Sattel nach hinten verlagert.



#### RELAXED 90°

The Relaxed rider typically sits upright with a 90-degree spine angle. This position places over 60% of the riders weight directly over the rear of the saddle.

Der Relaxed-Fahrer sitzt in der Regel aufrecht mit einem Wirbelsäulenwinkel von 90 Grad. In dieser Position liegt mehr als 60% des Fahrergewichts direkt auf dem hinteren Sattelbereich.



## 5 DIFFERENT LINES FOR DIFFERENT CYCLISTS: 5 VERSCHIEDENE LINIEN FÜR VERSCHIEDENE RADFAHRER:

### ezone

eZONE combines Acceleration Control, eFit Design, and special features to offer improved comfort, safety and control to eBike users.

eZONE kombiniert Acceleration Control für ein angenehmeres Gefühl beim Beschleunigen, eFit Design für mehr Komfort und viele weitere eBikespezifische Features, die Komfort und Sicherheit für Elektroradfahrer spürbar erhöhen.



### respiro

The top of our line. A central ventilation channel keeps you cool twice as long as ordinary saddles, while the unique ergonomic shape increases comfort by minimizing pressure.

Unsere Top Linie. Verglichen mit herkömmlichen Sätteln verhindert der zentrale Belüftungskanal doppelt so lange Hitzebildung im Sattel. Durch die einzigartige, ergonomische Form wird der Komfort erhöht und Druckstellen werden gemindert.



### LOOKIN

Observe the Royalgel™ experience through windows on the saddle's cover. This line, due to its lighter weight, is dedicated to trekking use.

Erleben Sie Royalgel™ durch Sichtfenster in der Satteloberfläche. Aufgrund des geringeren Gewichts empfehlen wir diese Linie für den Einsatz an Trekking Rädern.



### Premium

Superior comfort for every taste. Premium saddles are made using our innovative Royal Vacuum Light technology that enables these saddles to be 100% sealed against the elements and 20% lighter. Models available for every bike and riding position.

Höchster Komfort für jeden Geschmack. Premium Sättel sind mit unserem innovativen Royal-Vacuum-Light-System (RVL) ausgestattet. Diese Technologie macht die Sättel 100% wasserdicht und bis zu 20% leichter. Diese Modelle sind bei jedem Fahrradtyp und jeder Sitzposition einsetzbar.



### Classic

Affordable comfort manufactured to Selle Royal quality standards guarantees a first class saddle. Models available for every bike and riding position.

CLASSIC ist unsere kostengünstige Reihe mit hohem Fahrkomfort. Wie gewohnt nach den hohen Maßstäben von Selle Royal hergestellt, erwartet Sie ein Sattel der Spitzenklasse.



# COMFORT FEATURES

Selle Royal has over 50 years' experience researching and developing innovative materials, designs and advanced technology to produce the most comfortable high performance saddles on the market. Check out on the technical table for each specific saddle to see if a particular feature is available.

Selle Royal hat mehr als 50 Jahre Erfahrung in der Erforschung und Entwicklung von innovativen Materialien, Designs und fortschrittlicher Technologie – das Ergebnis: die komfortabelsten und leistungsfähigsten Sättel auf dem Markt. Hier sehen Sie eine Auflistung der exklusiven Eigenschaften von Selle Royal Produkten. In der technischen Tabelle können Sie nachsehen, ob bestimmte Eigenschaften bei den einzelnen Sätteln verfügbar sind.



**3D SKINGEL**  
3D Skingel is an advanced, flexible system where Royalgel™ is placed strategically according to the anatomical needs of the rider, resulting in a lighter weight saddle, while maintaining pressure reduction on the perineal and ischial areas up to 40%.

3D SKINGEL ist ein innovatives und flexibles System, in dem das Royalgel™ strategisch nach den anatomischen Bedürfnissen des Fahrers platziert wird, für ein leichteres Gewicht des Sattels sorgt, und den Druck auf den Sitzknochen und im Dammbereich bis zu 40% reduziert.



**SLOW FIT FOAM**  
With its unique slow recovery property, this memory foam provides superior comfort by molding itself to fit the shape of the body's contact points, creating more uniform pressure distribution while maintaining effective support.

Dank seiner besonders langsamen Rückstellungseigenschaften, garantiert dieser Memory-Schaum bestmöglichen Komfort: Er passt sich individuell und exakt den Kontaktpunkten des Körpers an, verteilt gleichmäßig den Druck und garantiert somit komfortables und zugleich effektives Fahren.



**SUPERFABRIC®**  
SuperFabric® is the ultimate cover material. It's made with two layers of fabric and one layer of micro-guard plates – there to protect the fabric beneath from damage. This precision-engineered combination creates a grippy external surface with guaranteed resistance to cuts, abrasions and punctures – without compromising on flexibility.

SuperFabric® ist das ultimative Material für den Sattelbezug. Es besteht aus zwei Gewebelagen und einer Lage Mikroschutzmaterial, um den Stoff darunter zu schützen. Diese feinmechanische Konstruktion erzeugt zudem eine rutschfeste Oberfläche, die nicht nur flexibel, sondern auch widerstandsfähig ist – etwa gegen Schnitte, Stiche oder andere Abnutzungerscheinungen.



**ROYALGEL™**  
Royalgel™ guarantees the highest level of comfort, reducing pressure peaks by up to 40% thanks to its unique tridimensional gel structure.

Royalgel™ garantiert ein Höchstmaß an Komfort, da es die Spitzenwerte bei der Druckeinwirkung dank der einmaligen dreidimensionalen Gelstruktur um bis zu 40% senkt.



**FOAM MATRIX**  
The foam matrix open cell structure confers increased elasticity and breathability to guarantee a durable and comfortable saddle.

Die offene Zellstruktur auf der Grundlage einer Schaummatrix verleiht erhöhte Elastizität und Atmungsfähigkeit, so dass ein haltbarer und bequemer Sattel entsteht.



**FLEXITE SYSTEM**  
The FLEXITE shell system was created to balance flexibility with strength – maximising performance through a unique, indented 'channel' structure on the bottom of the saddle body. This innovative construction guarantees extraordinary flexibility and shock absorption during riding.

Das FLEXLITE-Sattelschalensystem wurde designt, um den Balanceakt zwischen Flexibilität und Steifigkeit bestmöglich zu meistern. Dabei wird die Performance zusätzlich durch eine einzigartige Kanalstruktur an der Unterseite des Sattelgehäuses erhöht – eine innovative Konstruktion, die eine außergewöhnliche Flexibilität und Stoßabsorbtion während der Fahrt garantiert.



**DOUBLE-COVER SIDE PROTECTION**  
A double-layer material applied to the sides of the saddle to double resistance against impacts and abrasions.

Ein doppellagiges Material, das an den Seiten des Sattels angebracht wird, um die Widerstandsfähigkeit gegen Stöße und Abrieb zu erhöhen.

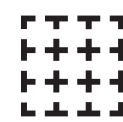

**STRENGTEX COVER**  
The cover is made from a unique layer of elastic material to guarantee a saddle of great durability.

Die Decke besteht aus einer einzigartigen Elastikschicht, die eine lange Haltbarkeit des Sattels garantiert.



**VENTILATION CHANNEL**  
Relieves pressure on the perineal area, while reducing uncomfortable perspiration.

Druckminderung im Perinealbereich bei gleichzeitiger Reduzierung unangenehmen Schwitzens.



**DOUBLE SPRINGS**  
Some Premium and Classic saddles are equipped with double springs to guarantee a great suspension with their two complementary movements.

Einige der Premium und Classic Sättel sind mit Doppelfedern ausgestattet, um durch ihre komplementären Bewegungen eine optimale Unterstützung zu gewährleisten.



**WATER RESISTANT**  
Royal Vacuum Light is a Selle Royal Technology that allows the saddle to be 100% sealed and 20% lighter than ordinary saddles of the same category.

Royal Vacuum Light ist eine Selle-Royal-Technologie, die gegenüber herkömmlichen Sätteln derselben Kategorie eine 100%ige Abdichtung und eine Gewichtsreduzierung um 20 % ermöglicht.

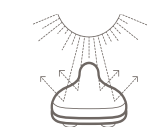

**COOL COVER**  
Our extraordinary cover is up to 25°C cooler than normal black saddles due to our special material which reflects sunlight.

Aufgrund eines besonderen, das Sonnenlicht reflektierenden Materials liegt die Temperatur unserer außergewöhnlichen Decke bis zu 25 °C unter der von normalen schwarzen Sätteln.



**ELASTOMERS**  
Safe, silent and permanently non-deformable, an elastomer can absorb even the severest and most unexpected shocks, because it works vertically and horizontally.

Sicher, leise und formstabil kann ein Elastomer die empfindlichsten und unerwartetsten Stöße abfangen, denn es arbeitet sowohl vertikal als auch horizontal.



**INTEGRATED CLIP SYSTEM**  
A patented clip system positioned at the rear of the saddle for easy attachment of a light or saddle bag.

Patentiertes Clip-System am Sattelende zum problemlosen Anbringen eines Lichts oder einer Satteltasche.

# ezone

Together with Designworks, a BMW Group subsidiary, Selle Royal undertook the first-ever, comprehensive study of eBike users to determine performance characteristics that could benefit from an eBike-specific saddle design.

The result is eZONE: the first saddle specifically developed to improve eBike safety, comfort and riding performance.

Gemeinsam mit der BMW-Tochter Designworks führte Selle Royal die erste umfassende Studie mit Fahrern von E-Bikes durch, um herauszufinden, an welchen Stellen eine für E-Bikes optimierte Sattelkonstruktion die größten Vorteile bietet.

Das Ergebnis ist eZONE: der erste Sattel, der eigens für die Verbesserung der Sicherheit, des Komforts und der Fahrleistungen von E-Bikes entwickelt wurde.

3D | SKINGEL

SELLE ROYAL

Designed by  
**Designworks**  
A BMW Group Company



# FEATURES

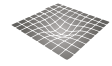

## 3D Skingel

A tridimensional gel structure that reduces pressure peaks by up to 40%, placed intelligently to reduce overall saddle weight.

Eine dreidimensionale Gel-Struktur, die den Satteldruck um bis zu 40 Prozent reduziert. Intelligently platziert, um Gewicht zu sparen.



## eFit Design

An elevated rear section to prevent backward sliding and shorter nose to aid in mounting.

Die Rückseite des Sattels ist leicht erhöht, um unangenehmes Zurückrutschen zu vermeiden und so die Sicherheit bei schnellen Beschleunigungsvorgängen zu verbessern. Die kürzere Nase erleichtert zudem das Aufsteigen.



## Acceleration Control

Three zones with specific shapes and dimensions, featuring flexible wings for enhanced control and balance, for added safety during acceleration.

Drei Zonen mit spezifischen Gestaltungsmerkmalen – unter anderem flexible Sattelflügel – helfen, Kontrolle und Balance beim Beschleunigung zu verbessern und die Sicherheit zu erhöhen.



## eGrip

A fibreglass handle integrated into the saddle rail, for easy manoeuvring while maintaining increased battery and accessories access.

Um das E-Bike einfach hochheben und tragen zu können, wurde ein Fieberglass-Griff in das Sattelgestänge integriert – für mehr Komfort auch abseits des Sattels.



# MODERATE



## eZONE

code 54B3UB0A091N5

sizes L 270 mm / W 170 mm / W 470 g

price € 89,90



# POP MATERIALS

## RETAIL STATION

Studied, minimal design and colours to complement any eBike retail sales environment.

- Pre-filled with 9 products, ready to sell.
- Free consumer test saddle displayed overhead in dedicated glorifier.
- Brochure holder with 10 detailed product brochures.

Durchdachtes, minimales Design und Farben, welche die Ausstattung eines jeden eBike Händlers ergänzen.

- Bereits mit neun verkaufsfertigen Produkten ausgestattet.
- Gratis Test-Sattel überkopf dargestellt in dazu passendem Display.
- Broschürenhalterung mit einem Set aus 10 detaillierten Produkt-Broschüren.

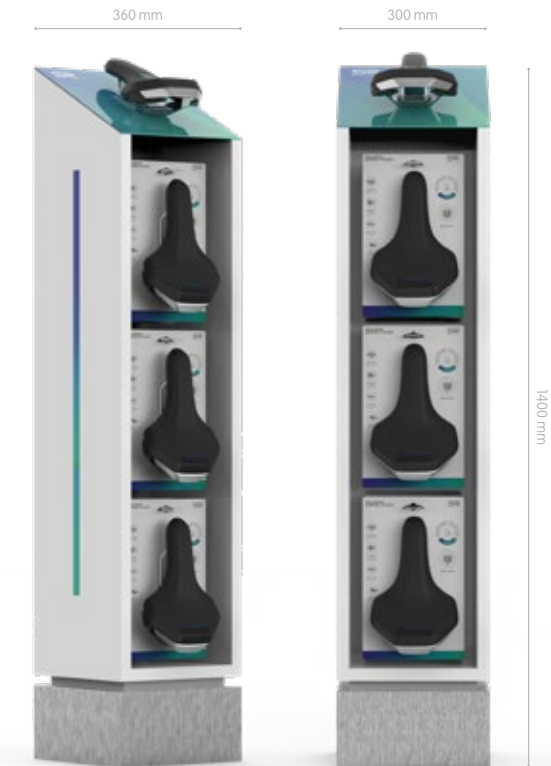

CODE: SREZONEA00000

## eZONE WALL DISPLAY

NEW

Informative wall display in 2 languages (English + German) with metalhooks slatwall/tegometall compatible.

- Free consumer test saddle already pre-charged.
- 4 eZone saddles for sale.
- eZone showcard in cardboard.

Informatives Wanddisplay in Deutsch und Englisch mit Metallhaken, kompatibel mit Slatwall und Tegometall.

- Kostenloser Testsattel für Kunden.
- 4 eZone Sättel zum Verkauf.
- eZone-Flyer im Karton.



CODE: SREZONEA10000



# respiro

Leaving a bike in the sun or riding in hot weather can raise your saddle temperature to an uncomfortable level. To avoid unpleasant perspiration and discomfort, the Respiro line is designed with a ventilation channel and special materials to minimize saddle heat.

Wenn Sie Ihr Rad in der Sonne stehenlassen oder bei sommerlichem Wetter fahren, kann die Temperatur des Sattels schnell auf ein unangenehmes Maß ansteigen. Die Respiro-Reihe ist zur Vermeidung von Schweißbildung und zur Erhöhung des Komforts mit einem Belüftungskanal und speziellen Materialien zur Verringerung der Hitzebildung im Sattel ausgestattet.

Discover which features are available for each saddle model. To find out more, go back to the "Features" section.

Welches Feature ist für welchen Sattel verfügbar? Alle Informationen hierzu findest du unter "Features".

## 45 | ATHLETIC

**RESPIRO SOFT**  UNISEX  
**code** 5130HRTB391L4  
**sizes** L 277 mm / W 163 mm / W 429 g  
**price** € 69,90



## 60 | MODERATE

**RESPIRO SOFT**  MEN  
**code** 5131HETB091L4  
**sizes** L 277 mm / W 182 mm / W 535 g  
**price** € 69,90



**RESPIRO SOFT**  WOMEN  
**code** 5131DETB091L4  
**sizes** L 263 mm / W 199 mm / W 565 g  
**price** € 69,90



## 90 | RELAXED

**RESPIRO SOFT**  UNISEX  
**codice** 5132DETB091L4  
**sizes** L 256 mm / W 227 mm / W 825 g  
**price** € 69,90



**LOOKIN**

Lookin combines a refreshed design in addition to the visible Royalgel™. These saddles are sealed with Royal Vacuum Light (RVL) technology that makes them water resistant.

Lookin ist eine neue Reihe, die ein überarbeitetes Design mit der sichtbaren Royalgel™ Polsterung kombiniert. Zudem sind diese Sättel, dank der neuen Royal Vacuum Light (RVL) Technologie, wasserfest.

Discover which features are available for each saddle model. To find out more, go back to the "Features" section.

Welches Feature ist für welchen Sattel verfügbar? Alle Informationen hierzu findest du unter "Features".

 | **ATHLETIC**

**LOOKIN BASIC**  UNISEX  
**code** 8229UR1A18096  
**sizes** L 283 mm / W 156 mm / W 440 g  
**price** € 39,90



 | **MODERATE**

**LOOKIN BASIC**  MEN  
**code** 8230HR1A18096  
**sizes** L 276 mm / W 162 mm / W 540 g  
**price** € 39,90



**LOOKIN BASIC**  WOMEN  
**code** 8230DR1A18096  
**sizes** L 258 mm / W 187 mm / W 560 g  
**price** € 39,90



 | **RELAXED**

**LOOKIN BASIC**  UNISEX  
**code** 8231UR1A18096  
**sizes** L 257 mm / W 212 mm / W 650 g  
**price** € 39,90



45' | ATHLETIC

LOOKIN  UNISEX

code 5234HR3A09188

sizes L 279 mm / W 160 mm / W 475 g

price € 59,90



60' | MODERATE

LOOKIN  MEN

code 5235HE3A09188

sizes L 282 mm / W 185 mm / W 555 g

price € 59,90



LOOKIN  WOMEN

code 5235DE3A09188

sizes L 269 mm / W 198 mm / W 620 g

price € 59,90



90' | RELAXED

LOOKIN  UNISEX

code 5236DE3A09188

sizes L 260 mm / W 228 mm / W 830 g

price € 59,90



# Premium

Superior comfort for every taste. Premium saddles are made using our innovative Royal Vacuum Light (RVL) to be 100% sealed and 20% lighter. Models are available for everybike and riding position.

Höchster Komfort für jeden Geschmack. Premium Sättel sind mit unserem innovativen Royal-Vacuum-Light-System (RVL) ausgestattet. Diese Technologie macht die Sättel 100% wasserdicht und bis zu 20% leichter. Diese Modelle sind bei jedem Fahrradtyp und jeder Sitzposition einsetzbar.

Discover which features are available for each saddle model. To find out more, go back to the "Features" section.

Welches Feature ist für welchen Sattel verfügbar? Alle Informationen hierzu findest du unter "Features".



## 45° | ATHLETIC

**ELLIPSE**  UNISEX  
**code** 51B5UR0A09320  
**sizes** L 265,5 mm / W 162,6 mm / W 406,3 g  
**price** € 49,90



NEW

## 60° | MODERATE

**ELLIPSE**  MEN  
**code** 51B6HE0A09321  
**sizes** L 276,1 mm / W 180 mm / W 474 g  
**price** € 49,90



NEW

**ELLIPSE**  WOMEN  
**code** 51B6DE0A09321  
**sizes** L 260,6 mm / W 197,5 mm / W 475,3 g  
**price** € 49,90



NEW

## 90° | RELAXED

**ELLIPSE**  UNISEX  
**code** 51B7UE0A09321  
**sizes** L 250,5 mm / W 223,4 mm / W 638 g  
**price** € 49,90



NEW



# Classic

Affordable comfort is found in our Classic line, manufactured to Selle Royal standards to guarantee a first-class saddle. This line utilizes Royalgel™ in most models, an exclusive polyurethane gel that delivers superior comfort by reducing peak pressures in the sensitive areas by up to 40%, some models are padded with Slow Fit Foam, a memory foam that molds to rider's body.

Classic ist unsere kostengünstige Reihe mit hohem Fahrkomfort. Wie gewohnt nach den hohen Maßstäben von Selle Royal hergestellt, erwartet Sie ein Sattel der Spitzenklasse. Diese Reihe bietet in der Regel eine Royalgel™-Polsterung; ein exklusives Polyurethan-Gel für höchsten Komfort, das eine hohe Druckentlastung in den empfindlichen Körperzonen von bis zu 40% bietet. Einige Modelle sind mit Slow Fit Schaum gepolstert, einem Memory Schaum, welcher sich der Kontur des Fahrers anpasst.

Discover which features are available for each saddle model. To find out more, go back to the "Features" section.

Welches Feature ist für welchen Sattel verfügbar? Alle Informationen hierzu findest du unter "Features".



## ATHLETIC

### FORUM

UNISEX

code A132UR0A08069

sizes L 276 mm / W 156 mm / W 453 g

price € 39,90



## MODERATE

### FORUM

MEN

code A133HR0A08069

sizes L 271 mm / W 180 mm / W 521 g

price € 39,90



### FORUM

WOMEN

code A133DR0A08069

sizes L 261 mm / W 189 mm / W 541 g

price € 39,90



## RELAXED

### FORUM

UNISEX

code A134UR0A08069

sizes L 247 mm / W 214 mm / W 561 g

price € 39,90



45° | ATHLETIC

**FREEWAY FIT**   
code 8V99UR0A08069  
sizes L 280 mm / W 158 mm / W 435 g  
price € 34,90



**SLOW FIT FOAM**



60° | MODERATE

**FREEWAY FIT**   
code 8V97HR0A08069  
sizes L 273 mm / W 160 mm / W 490 g  
price € 34,90



**SLOW FIT FOAM**



**FREEWAY FIT**   
code 8V97DR0A08069  
sizes L 260 mm / W 188 mm / W 520 g  
price € 34,90



**SLOW FIT FOAM**



90° | RELAXED

**FREEWAY FIT**   
code 8V98UR0A08069  
sizes L 257 mm / W 210 mm / W 550 g  
price € 34,90



**SLOW FIT FOAM**



45° | ATHLETIC

**MACH 2**   
code A008UR0A05515  
sizes L 268 mm / W 142 mm / W 369 g  
price € 29,90



**SLOW FIT FOAM**



60° | MODERATE

**ROOMY**   
code 8VA8HS0A08069  
sizes L 265 mm / W 165 mm / W 605 g  
price € 24,90



**SLOW FIT FOAM**



**ROOMY**   
code 8VA8DS0A08069  
sizes L 246 mm / W 181 mm / W 580 g  
price € 24,90



**SLOW FIT FOAM**



90° | RELAXED

**AURORAE**   
code 8VB4UE0A08069  
sizes L 254 mm / W 231 mm / W 673 g  
price € 24,90



**SLOW FIT FOAM**



**DRIFTER STRENTEX BLACK**

UNISEX

code 5111UDTC25301

sizes L 270 mm / W 245 mm / W 1160 g

price € 49,90



**DRIFTER PLUS BROWN**

UNISEX

code 5111UDTC38129

sizes L 270 mm / W 245 mm / W 1260 g

price € 49,90



**ONDINA BROWN**

UNISEX

code 8171US A38129

sizes L 253 mm / W 214 mm / W 690 g

price € 29,90



**HOLLAND GEL**

UNISEX

code 82615G2A08132

sizes L 247 mm / W 219 mm / W 690 g

price € 24,90



**WITCH**

UNISEX

code 8013USTA08096

sizes L 260 mm / W 243 mm / W 651 g

price € 19,90



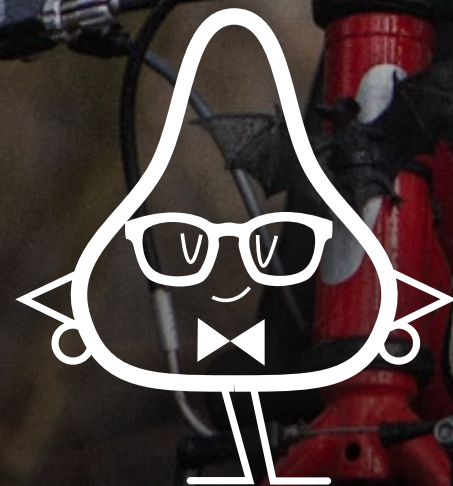

**ENJOY YOUR  
BIKE IN SAFETY  
WITH MR. ROY**

A project in collaboration with:



**FROGGY** BOY & GIRL

code 1702JCNA03807

sizes L 202 mm / W 150 mm / W 290 g

price € 9,90



Suggested for 12"-14"-16" kids bike  
Passend für 12", 14" oder 16"-Kinderräder

**CANDY** GIRL

code 1703DRNA03807

sizes L 230 mm / W 172 mm / W 331 g

price € 9,90



Suggested for 16"-20"-24" girl's bike  
Candy ist ein Sattel für Mädchen,  
die mit 16"-, 20"- oder 24"-Bikes unterwegs sind

**BEN** BOY

code 1703HRNA03807

sizes L 230 mm / W 151 mm / W 305 g

price € 9,90



Suggested for 16"-20"-24" boy's bike  
Ben ist ein Sattel für Jungs,  
die mit 16"-, 20"- oder 24"-Bikes unterwegs sind

**HELLO** BOY & GIRL

code 1704JRNA03807

sizes L 250 mm / W 151 mm / W 337 g

price € 9,90



Suggested for 24" junior bike  
Ein Sitz für 24"-Kinderräder



## SEAT COVERS

### GEL SEAT COVER MEDIUM INDENT

code SCGM100A25800

sizes L 285 mm / W 195 mm / W 363 g

price € 16,90

UNISEX

ROYALGEL™



### GEL SEAT COVER LARGE INDENT

code SCGL100A15800

sizes L 258 mm / W 226 mm / W 264 g

price € 16,90

UNISEX

ROYALGEL™



### MEMORY FOAM SEAT COVER MEDIUM INDENT

code SCMM003A05800

sizes L 277 mm / W 192 mm / W 242 g

price € 14,90

UNISEX

SLOW FIT FOAM



### MEMORY FOAM SEAT COVER LARGE INDENT

code SCML004A05800

sizes L 248 mm / W 220 mm / W 289 g

price € 14,90

UNISEX

SLOW FIT FOAM



## BAG

### SR SADDLE BAG

code BAGS100A00000

sizes L 131 mm / W 106 mm / W 102 g

price € 16,90



## CLAMP

### BLACK CLAMP 3 COMPONENTS

single packaging

code V 06 B20000

price € 2,95

### SILVER CLAMP 3 COMPONENTS

single packaging

code V 06 B00000

price € 2,45

### SILVER CLAMP 5 COMPONENTS 38 D.

single packaging

code V 06 B40000

price € 2,45

### BLACK CLAMP 3 COMPONENTS + DADO AUTOBL.

code V 06 B70000

price € 1,99

### SILVER CLAMP 5 COMPONENTS 38 D.

code V 06 B80000

price € 1,99

### SILVER CLAMP 3 COMPONENTS + DADO AUTOBL.

code V 06 B60000

price € 1,75



## SPARE PARTS

The Original Spare Parts by Selle Royal are saddles used for spare parts and are supplied in dedicated masterboxes. They are provided with a special descriptive hangtag.

Die Original Spare Parts by Selle Royal sind Austausch Sättel für spezielle Bedürfnisse unserer Kunden. Jeder Sattel wird in einer eigens für ihn gefertigten Box, mitsamt speziellem Hangtag geliefert.

### | ATHLETIC



**MACH - Box**  UNISEX  
code SRTC C70000  
qty/box 28 pcs



**LANCIA - Box**  UNISEX  
code SRTC C80000  
qty/box 20 pcs



**ALPINE - Box**  UNISEX  
code SRTC C90000  
qty/box 24 pcs

### | MODERATE



**MOODY - Box**  WOMEN  
code SRTC C10000  
qty/box 18 pcs

### | RELAXED



**HOLLAND NO GEL - Box**  UNISEX  
code SRTC C40000  
qty/box 11 pcs





  
r.e.med

## THE ERGONOMIC APPROACH | DER ERGONOMISCHE ANSATZ

R.e.Med saddles are designed to allow the body to naturally redistribute stress by offering 3 corresponding Saddle Zones: **ACTIVE**, **RECOVERY** and **SUPPORT** to correlate to the 3 riding positions, providing relief and comfort by equalizing pressure as you shift position between the front and rear of the saddle.

ReMed Sättel wurden design't um es dem Körper zu ermöglichen, die auftretende Belastung natürlich auf 3 Sattelzonen zu verteilen: **AKTIV**, **ERHOLUNG** und **UNTERSTÜTZUNG**, diese bieten Entlastung und Komfort, das Polster behält dabei unverändert seinen Druck, auch wenn Sie die Sitzposition von vorne nach hinten verlagern.

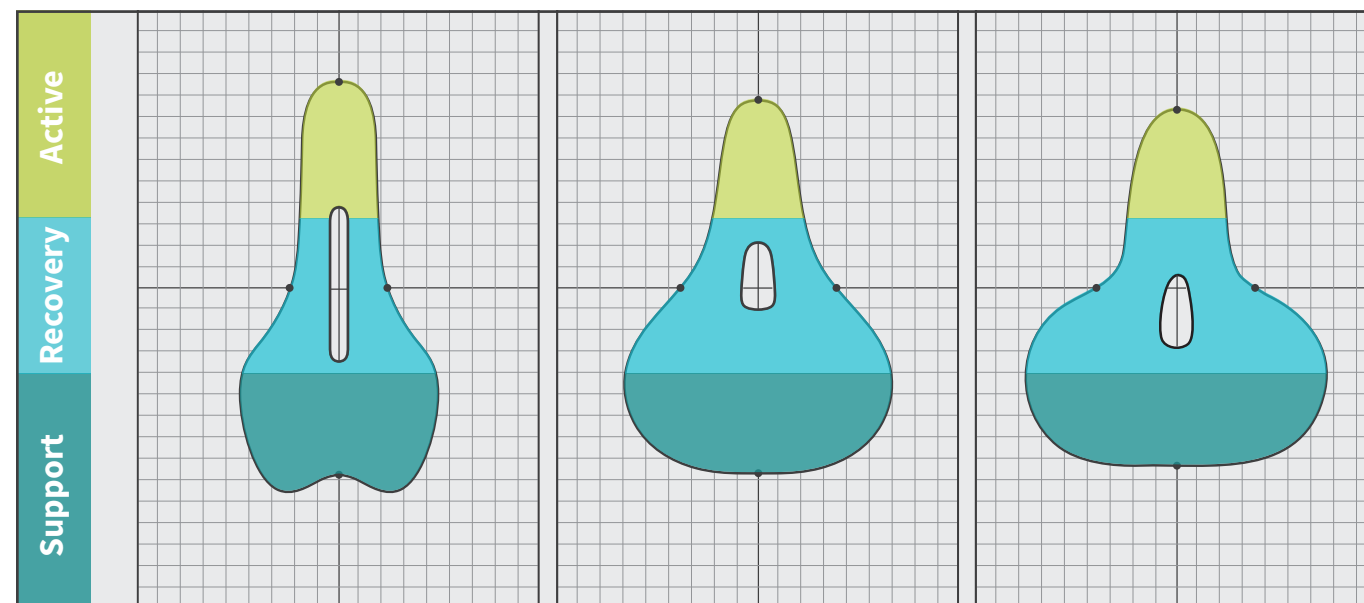

### THE FEATURES

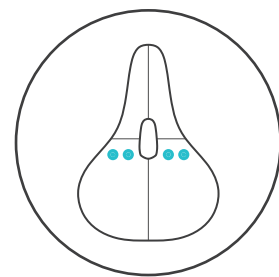

Specific Ergonomic Design

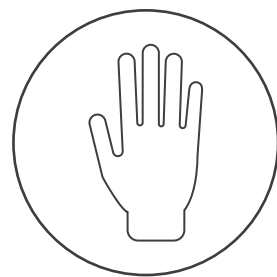

Handmade

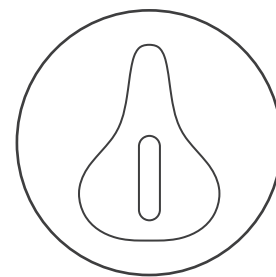

Anatomic Hole

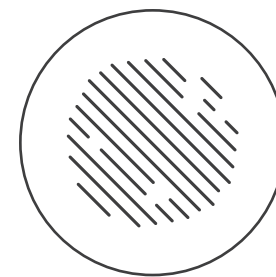

Memory Foam

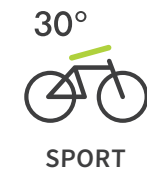

#### REMED SPORT

code 2354HRMA10004

sizes L 287 mm / W 136 mm / W 316 g

price € 19,90



#### REMED TREKKING

code 4309DEMA10004

sizes L 257 mm / W 189 mm / W 578 g

price € 19,90

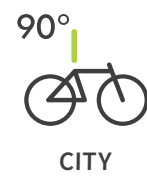

#### REMED CITY

code 5550UEMA10003

sizes L 249 mm / W 207 mm / W 633 g

price € 19,90





designed in japan / made in italy



# RIDE COLLECTION

 SPRING/SUMMER  FALL/WINTER

**PEdAL ED**



00PE\_BLACK

05PE\_NAVY

NEW

## YUKY WINTER JACKET



- WATER RESISTANT (10.000MM W/C)
- THERMO REGULATION & BREATHABLE
- STRETCH MATERIAL & REFLECTIVE DETAILS
- 5 POCKETS
- WATERPROOF VALUE POCKET
- MADE IN ITALY

85%PA - 15%EA EXTERNAL / 92%PES - 8%EA INTERNAL

CODE 17WJKWI

COLOR ● 00PE\_Black  
● 05PE\_Navy

SIZES XXS / XS / S / M / L / XL / XXL

PRICE € 310



00PE\_BLACK

13PE\_BORDEAUX

07PE\_BLUE

NEW

## TOKAIDO ALPHA JACKET



- THERMO REGULATION
- REFLECTIVE DETAILS
- ULTRALIGHT & PACKABLE
- POLARTEC ALPHA®
- MADE IN ITALY

100% PA / 100%PES PADDING

CODE 184JTK

COLOR ● 00PE\_Black ● 13PE\_Bordeaux  
● 07PE\_Blue

SIZES XXS / XS / S / M / L / XL / XXL

PRICE € 220



00PE\_BLACK

07PE\_BLUE

## NACHI WATERPROOF JACKET



- WATERPROOF
- FULLY TAPED SEAMS
- WINDPROOF
- WATER-RESISTANT ZIP
- SLIM FIT FOR PERFORMANCE
- MADE IN ITALY

100%PA

CODE 174JKGF

COLOR ● 00PE\_Black  
● 07PE\_Blue

SIZES XS / S / M / L / XL / XXL

PRICE € 210



02PE\_GREY

17PE\_CORAL RED

NEW

## HIKARI REFLECTIVE SHELL



- WATERPROOF (10.000MM W/C)
- TAPED SEAMS
- STRETCH MATERIAL & REFLECTIVE DETAILS
- MADE IN ITALY

85% POLIAMIDE - 15% ELASTAN / 100% POLIURETANO

CODE 184JKRE

COLOR ● 02PE\_Grey  
● 17PE\_Coral Red

SIZES XXS / XS / S / M / L / XL / XXL

PRICE € 265



00PE\_BLACK

01PE\_WHITE

## FUJI TEAM JACKET



- WINDPROOF FRONT PANEL
- PERFORMANCE SLIM FIT
- BREATHABLE STRETCH FLEECE SIDE PANELS
- MADE IN ITALY

74%PP - 26%EA

CODE 17WJKFJ

COLOR ● 00PE\_Black  
● 01PE\_White

SIZES XXS / XS / S / M / L / XL / XXL

PRICE € 180



00PE\_BLACK

05PE\_NAVY

01PE\_WHITE

## VESPER PACKABLE JACKET



- WINDPROOF
- REFLECTIVE DETAILS
- LIGHTWEIGHT PACKABLE
- SLIM FIT FOR PERFORMANCE
- MADE IN ITALY

87%PL - 13%EA

CODE 17WJKVS

COLOR ● 00PE\_Black ● 01PE\_White  
● 05PE\_Navy

SIZES XXS / XS / S / M / L / XL / XXL

PRICE € 97





00PE\_BLACK 13PE\_BORDEAUX 07PE\_BLUE

**NEW** TOKAIDO ALPHA PACKABLE VEST ❄️

- REGULAR FIT
- THERMO REGULATION
- DRY FAST
- REFLECTIVE DETAILS

- THERMO REGULATION & BREATHABLE  
- REFLECTIVE DETAILS  
- ULTRALIGHT & PACKABLE  
- MADE IN ITALY

100% PA / 100% PES PADDING

CODE 184VETK  
 COLOR ● 00PE\_Black ● 13PE\_Bordeaux  
 ● 07PE\_Blue  
 SIZES XXS / XS / S / M / L / XL / XXL  
 PRICE € 168



00PE\_BLACK 07PE\_BLUE

NACHI WATERPROOF VEST ☀️ ❄️

- REGULAR FIT
- WATER PROOF
- WATER RESISTANT
- WIND PROOF
- THERMO REGULATION
- DRY FAST
- REFLECTIVE DETAILS

- WATERPROOF  
- WINDPROOF  
- WATER-RESISTANT ZIP  
- SLIM FIT FOR PERFORMANCE  
- MADE IN ITALY

85%PA - 15%EA

CODE 174VENC  
 COLOR ● 00PE\_Black  
 ● 07PE\_Blue  
 SIZES XS / S / M / L / XL / XXL  
 PRICE € 109



00PE\_BLACK 01PE\_WHITE

KAZE ACCESS VEST ☀️ ❄️

- SLIM FIT
- WATER PROOF
- WATER RESISTANT
- WIND PROOF
- THERMO REGULATION
- REFLECTIVE DETAILS

- WINDPROOF & WATERPROOF MEMBRANE  
- CHEST POCKET  
- PACKABLE  
- MADE IN ITALY

100%PA

CODE 164JKVE  
 COLOR ● 00PE\_Black  
 ● 01PE\_White  
 SIZES XXS / XS / S / M / L / XL / XXL  
 PRICE € 98



00PE\_BLACK 05PE\_NAVY 01PE\_WHITE

VESPER PACKABLE VEST ☀️

- REGULAR FIT
- WATER RESISTANT
- WIND PROOF
- REFLECTIVE DETAILS

- WINDPROOF  
- REFLECTIVE DETAILS  
- LIGHTWEIGHT PACKABLE  
- SLIM FIT FOR PERFORMANCE  
- MADE IN ITALY

87%PL - 13%EA

CODE 18SVEVS  
 COLOR ● 00PE\_Black ● 01PE\_White  
 ● 05PE\_Navy  
 SIZES XXS / XS / S / M / L / XL / XXL  
 PRICE € 87



00PE\_BLACK



01PE\_WHITE



17PE\_CORAL RED

**NEW** **KOBE THERMO JERSEY** ❄️

- REGULAR FIT
- WATER PROOF
- WATER RESISTANT
- WIND PROOF
- THERMO REGULATION
- DRY FAST
- REFLECTIVE DETAILS

- DRY FAST
- BREATHABLE STRETCH FLEECE SIDE PANELS AND BACK
- PERFORMANCE FIT FOR RIDING
- 2 BIG BACK POCKETS
- MADE IN ITALY

85%PA - 15%EA

**CODE** 17WJKKT  
**COLOR** ● 00PE\_Black ● 17PE\_Coral Red  
 ● 01PE\_White  
**SIZES** XS / S / M / L / XL / XXL  
**PRICE** € 150



00PE\_BLACK



02PE\_GREY



03PE\_MILITARY GREEN



13PE\_BORDEAUX

**KAIDO JERSEY LONG** ❄️

- REGULAR FIT
- THERMO REGULATION
- DRY FAST
- REFLECTIVE DETAILS

- BREATHABLE MERINO WOOL
- THERMO REGULATING & FAST DRYING
- COMFORT FIT & REFLECTIVE DETAILS
- MADE IN ITALY

49%WO - 49%PP - 2%EA

**CODE** 16WJSKL  
**COLOR** ● 00PE\_Black ● 03PE\_Military Green  
 ● 02PE\_Grey ● 13PE\_Bordeaux  
**SIZES** XS / S / M / L / XL / XXL  
**PRICE** € 145



00PE\_BLACK

**SHAWA JERSEY** ☀️ ❄️

- REGULAR FIT
- WATER PROOF
- WATER RESISTANT
- WIND PROOF
- THERMO REGULATION
- DRY FAST
- REFLECTIVE DETAILS

- WATERPROOF
- WINDPROOF
- TAPED SEAMS
- STRETCH FABRIC
- WATER-RESISTANT ZIP
- SLIM FIT FOR PERFORMANCE
- MADE IN ITALY

86%PL - 14%EA

**CODE** 17WJSSA  
**COLOR** ● 00PE\_Black  
**SIZES** XXS / XS / S / M / L / XL / XXL  
**PRICE** € 187



00PE\_BLACK



02PE\_GREY



03PE\_M.GREEN



07PE\_BLUE



13PE\_BORDEAUX



14PE\_BROWN

**KAIDO JERSEY** ☀️ ❄️

- REGULAR FIT
- THERMO REGULATION
- DRY FAST
- REFLECTIVE DETAILS

- BREATHABLE MERINO WOOL
- THERMO REGULATING & FAST DRYING
- COMFORT FIT & REFLECTIVE DETAILS
- MADE IN ITALY

49%WO - 49%PP - 2%EA

**CODE** 154JSKI  
**COLOR** ● 00PE\_Black ● 07PE\_Blue ● 13PE\_Bordeaux  
 ● 02PE\_Grey ● 14PE\_Brown ● 03PE\_M.Green  
**SIZES** XS / S / M / L / XL / XXL  
**PRICE** € 110



00PE\_BLACK 02PE\_GREY 07PE\_BLUE 13PE\_BORDEAUX

## ESSENTIAL LONG SLEEVE



- MERINO BREATHABLE STRETCH FABRIC
- LYCRA RIB CUFFS
- REFLECTIVE ELEMENTS
- 3 BIG BACK POCKETS
- EAR PHONE OPENING IN THE BACK POCKET
- MADE IN ITALY

30% MERINO WOOL - 70% POLYESTER

CODE 17WJSES

COLOR ● 00PE\_Black ● 07PE\_Blue  
● 02PE\_Grey ● 13PE\_Bordeaux

SIZES XS / S / M / L / XL / XXL

PRICE € 125



00PE\_BLACK 05PE\_NAVY 06PE\_RED 15PE\_YELLOW 01PE\_WHITE 17PE\_CORAL RED

## SHIBUYA LIGHTWEIGHT JERSEY



- 115 GRAMS M SIZE
- ULTRA LIGHT WEIGHT AND BREATHABLE
- COMPRESSION FIT FOR AERODYNAMIC
- SLIM FIT FOR PERFORMANCE
- MADE IN ITALY

74%PP - 26%EA

CODE 164JSLW

COLOR ● 00PE\_Black ● 05PE\_Navy ● 01PE\_White  
● 06PE\_Red ● 15PE\_Yellow ● 17PE\_Coral Red

SIZES XS / S / M / L / XL / XXL

PRICE € 135



00PE\_BLACK 01PE\_WHITE 05PE\_NAVY 13PE\_BORDEAUX

## NARITA CARBON JERSEY



- BREATHABLE & ANTIBACTERIAL
- 3 POCKETS + ZIPPED VALUABLES POCKET
- SLIM FIT & REFLECTIVE DETAILS
- MADE IN ITALY

100%PL

CODE 164JSNC

COLOR ● 00PE\_Black ● 05PE\_Navy  
● 01PE\_White ● 13PE\_Bordeaux

SIZES XS / S / M / L / XL / XXL

PRICE € 120



01PE\_WHITE 02PE\_GREY 06PE\_RED 07PE\_BLUE 12PE\_ORANGE

## HEIKO JERSEY



- UV PROTECTION FABRIC
- LIGHTWEIGHT AND BREATHABLE
- COMPRESSION FIT FOR AERODYNAMIC
- SLIM FIT FOR PERFORMANCE
- MADE IN ITALY

73%PA - 27%EA

CODE 184JSHK

COLOR ● 02PE\_Grey ● 06PE\_Red ● 12PE\_Orange  
● 01PE\_White ● 07PE\_Blue

SIZES XS / S / M / L / XL / XXL

PRICE € 100



00PE\_BLACK 06PE\_RED 07PE\_BLUE

# NAGOYA AERO JERSEY



- 109 GRAMS M SIZE
- ULTRA LIGHT WEIGHT AND BREATHABLE
- COMPRESSION FIT FOR AERODYNAMIC
- SLIM FIT FOR PERFORMANCE
- MADE IN ITALY

74%PL - 26%EA

CODE 17SJSNA  
 COLOR ● 00PE\_Black ● 07PE\_Blue  
 ● 06PE\_Red  
 SIZES XS / S / M / L / XL / XXL  
 PRICE € 160



00PE\_BLACK

# ULTRALIGHT BASELAYER



- DRY FAST WITH DRYARN®
- THERMO REGULATING & BREATHABLE
- ODOR CONTROL
- MADE IN ITALY

89%PP - 11%EA

CODE 164JSUL  
 COLOR ● 00PE\_Black  
 SIZES XS / S / M / L / XL / XXL  
 PRICE € 55



00PE\_BLACK

# ULTRALIGHT BASELAYER SLEEVELESS



- DRY FAST WITH DRYARN®
- THERMO REGULATING & BREATHABLE
- ODOR CONTROL
- MADE IN ITALY

89%PP - 11%EA

CODE 164JSUS  
 COLOR ● 00PE\_Black  
 SIZES S / M / L / XL / XXL  
 PRICE € 48





00PE\_BLACK



00PE\_BLACK

07PE\_BLUE

17PE\_CORAL RED

13PE\_BORDEAUX

## MERINO BASELAYER LONG SLEEVE



- BREATHABLE STRETCH FLEECE
- PERFORMANCE FIT FOR RIDING
- FABRIC HELPS KEEP YOU DRY AND COMFORTABLE
- ERGONOMIC CUT FOR STRETCH AND MOBILITY
- MADE IN ITALY

100%WO

CODE 17WJSML

COLOR ● 00PE\_Black

SIZES XS / S / M / L / XL / XXL

PRICE € 70

## MERINO BASELAYER SLEEVELESS



- BREATHABLE STRETCH FLEECE
- PERFORMANCE FIT FOR RIDING
- FABRIC HELPS KEEP YOU DRY AND COMFORTABLE
- ERGONOMIC CUT FOR STRETCH AND MOBILITY
- MADE IN ITALY

67% WO - 22%PA - 11%EA

CODE 184JSMS

COLOR ● 00PE\_Black ● 17PE\_Coral Red  
● 07PE\_Blue ● 13PE\_Bordeaux

SIZES XXS / XS / S / M / L / XL / XXL

PRICE € 60





00PE\_BLACK

## TEAM WINTER TIGHT



- DRY FAST
- WIND PROOF FRONT PANNEL
- INTERNAL FLEECE
- SLIM FIT FOR PERFORMANCE
- MADE IN ITALY

85%PA - 15%EA

CODE 17WSPWT

COLOR ● 00PE\_Black

SIZES XS / S / M / L / XL / XXL

PRICE € 178



00PE\_BLACK

## DAIKANN WINTER BIBSHORT



- DRY FAST
- REFLECTIVE LOGOS
- INTERNAL FLEECE
- SLIM FIT FOR PERFORMANCE
- MADE IN ITALY

85%PA - 15%EA

CODE 16WSPBB

COLOR ● 00PE\_Black

SIZES XS / S / M / L / XL / XXL

PRICE € 155



00PE\_BLACK

## NAGOYA AERO BIBSHORT



- BREATHABLE & FAST DRYING
- TOP-PERFORMANCE CYTECH® PAD
- CUFFS FOR SENSITIVE SKIN
- CUT FOR AERODYNAMIC PERFORMANCE
- MADE IN ITALY

53%PA - 43%EA

CODE 17SSPNA

COLOR ● 00PE\_Black

SIZES XS / S / M / L / XL / XXL

PRICE € 180



00PE\_BLACK

14PE\_BROWN

## RAKU BIBSHORT



- MID-SEASON FABRIC FOR THERMO REGULATION
- PANEL CONSTRUCTION FOR THE BEST FIT
- MESH BACK PANELS ENHANCE BREATHABILITY
- FLAT SEAMS MOVE SMOOTHLY AGAINST YOUR SKIN
- BACTERIOSTATIC PAD BY ELASTIC INTERFACE®
- REGULAR FIT FOR COMFORT
- MADE IN ITALY

59%PA - 41%EA

CODE 154SPBB

COLOR ● 00PE\_Black

● 14PE\_Brown

SIZES XS / S / M / L / XL / XXL

PRICE € 120



00PE\_BLACK 05PE\_NAVY 13PE\_BORDEAUX

## NATSU BIBSHORT



- BREATHABLE & FAST DRYING
- TOP-PERFORMANCE CYTECH® PAD
- CUFFS FOR SENSITIVE SKIN
- HIGH CUT WAIST FOR COMFORT FIT
- MADE IN ITALY

85%PA - 15%EA

CODE 15SSPBB

COLOR ● 00PE\_Black ● 05PE\_Navy  
● 13PE\_Bordeaux

SIZES XS / S / M / L / XL / XXL

PRICE € 135



00PE\_BLACK

## 3/4 BIBSHORT



- DRY FAST
- WIND PROOF FRONT PANNEL
- INTERNAL FLEECE
- SLIM FIT FOR PERFORMANCE
- MADE IN ITALY

100%PL - 85%PL - 15%EA

CODE 17WSPKN

COLOR ● 00PE\_Black

SIZES XS / S / M / L / XL / XXL

PRICE € 160



01PE\_WHITE 02PE\_GREY 06PE\_RED 07PE\_BLUE 12PE\_ORANGE

## HEIKO BIBSHORT



- BREATHABLE & FAST DRYING
- TOP-PERFORMANCE CYTECH® PAD
- CUFFS FOR SENSITIVE SKIN
- HIGH CUT WAIST FOR COMFORT FIT
- MADE IN ITALY

78%PA - 22%EA

CODE 184BBHK

COLOR ● 02PE\_Grey ● 06PE\_Red ● 12PE\_Orange  
● 01PE\_White ● 07PE\_Blue

SIZES XS / S / M / L / XL / XXL

PRICE € 120



00PE\_BLACK

## KYOTO GRAVEL SHORTS



- PERFORMANCE FABRIC
- STRETCH SADDLE ZONE
- SEALED POCKET
- SLIM FIT FOR PERFORMANCE
- MADE IN ITALY

100%PL

CODE 16SSPGR

COLOR ● 00PE\_Black

SIZES XS / S / M / L / XL / XXL

PRICE € 115



00PE\_BLACK

**NEW** **SHAWA REFLECTIVE CAP** ❄️

- REFLECTIVE DETAILS
- WATERPROOF
- BREATHABLE
- STRETCH FABRIC
- MADE IN ITALY

86% PL - 14% EA

**CODE** 18WCASA  
**COLOR** ● 00PE\_Black  
**SIZES** UNIQUE  
**PRICE** € 45

**WINTER CYCLING HAT** ❄️

- WINDPROOF
- WINDTEX® FABRIC
- BREATHABLE
- ONE SIZE FITS ALL
- MADE IN ITALY

100%PL

**CODE** 15WCAWT  
**COLOR** ● 00PE\_Black  
**SIZES** UNIQUE  
**PRICE** € 35

**WINTER SKULL CAP** ❄️

- REFLECTIVE DETAILS
- THERMO REGULATION
- WINDPROOF
- STRETCH FABRIC
- BREATHABLE
- MADE IN EU

85%PA - 15%EA

**CODE** 17WCASK  
**COLOR** ● 00PE\_Black  
**SIZES** UNIQUE  
**PRICE** € 27



01PE\_WHITE    05PE\_NAVY    11PE\_GREEN    13PE\_BORDEAUX

**SUMMER CAP BANDANA** ☀️ ❄️

- REGULAR FIT
- DRY FAST

- ORIGINAL JAPANESE BANDANA FABRIC
- BREATHABLE & COMFORT FIT
- LIGHTWEIGHT & NATURAL
- MADE IN ITALY

100%CO

**CODE** 164CASC  
**COLOR** ● 01PE\_White    ● 11PE\_Green  
 ● 05PE\_Navy    ● 13PE\_Bordeaux  
**SIZES** UNIQUE  
**PRICE** € 20





00PE\_BLACK 02PE\_GREY 13PE\_BORDEAUX 07PE\_BLUE 14PE\_BROWN 03PE\_MIL.GREEN



00PE\_BLACK 13PE\_BORDEAUX 07PE\_BLUE

## KUBI NECK WARMER



- BREATHABLE MERINO WOOL
- THERMO REGULATING & FAST DRYING
- COMFORT FIT & REFLECTIVE DETAILS
- MADE IN ITALY

49%WO - 49%PP - 2%EA

CODE 164ACNW  
 COLOR ● 00PE\_Black ● 03PE\_M.Green ● 14PE\_Brown  
 ● 02PE\_Grey ● 07PE\_Blue ● 13PE\_Bordeaux  
 SIZES UNIQUE  
 PRICE € 20

NEW

## TOKAIDO ALPHA NECK WARMER



- THERMO REGULATION & BREATHABLE
- REFLECTIVE DETAILS
- ULTRALIGHT & PACKABLE
- MADE IN ITALY

100% PA / 100%PES PADDING

CODE 18WACNW  
 COLOR ● 00PE\_Black ● 13PE\_Bordeaux  
 ● 07PE\_Blue  
 SIZES UNIQUE  
 PRICE € 46



00PE\_BLACK



00PE\_BLACK

## LEG WARMER



- REFLECTIVE DETAILS
- THERMO REGULATING
- COMFORT FIT & STRETCH FABRIC
- MADE IN ITALY

85% POLYAMIDE - 15% ELASTANE

CODE 16WACLW  
 COLOR ● 00PE\_Black  
 SIZES XS / S / M / L / XL  
 PRICE € 50

## TEAM ARM WARMER



- LIGHTWEIGHT AND BREATHABLE
- COMPRESSION FIT FOR AERODYNAMIC
- SLIM FIT FOR PERFORMANCE
- MADE IN ITALY

85%PA - 15%EA

CODE 16SACFA  
 COLOR ● 00PE\_Black  
 SIZES XS / S / M / L / XL / XXL  
 PRICE € 40



# KAIDO ARM WARMER



- BREATHABLE MERINO WOOL
- THERMO REGULATING & FAST DRYING
- COMFORT FIT & REFLECTIVE DETAILS
- MADE IN ITALY

80%PL - 10%EA

**CODE** 154AWKA  
**COLOR** ● 00PE\_Black ● 07PE\_Blue ● 03PE\_M.Green  
 ● 02PE\_Grey ● 14PE\_Brown ● 13PE\_Bordeaux  
**SIZES** XS / S / M / L / XL / XXL  
**PRICE** € 40

00PE\_BLACK 02PE\_GREY 03PE\_MIL.GREEN 07PE\_BLUE 14PE\_BROWN 13PE\_BORDEAUX



NEW

# HEIKO ARM WARMER



- UV PROTECTION FABRIC
- BREATHABLE
- DRY FAST
- ULTRALIGHT MATERIAL
- STRETCH FABRIC
- MADE IN ITALY

73% MICROFIBRE PA - 27 % EA (LYCRA®)

**CODE** 184AWHK  
**COLOR** ● 01PE\_White ● 07PE\_Blue ● 12PE\_Orange  
 ● 02PE\_Grey ● 06PE\_Red  
**SIZES** XXS / XS / S / M / L / XL  
**PRICE** € 37

01PE\_WHITE 02PE\_GREY 06PE\_RED 07PE\_BLUE 12PE\_ORANGE



# SHAWA ARM WARMER



- WATERPROOF
- WINDPROOF
- TAPED SEAMS
- STRETCH FABRIC
- WATER-RESISTANT ZIP
- SLIM FIT FOR PERFORMANCE
- MADE IN ITALY

85%PL - 15%EA

**CODE** 17WACSA  
**COLOR** ● 00PE\_Black  
**SIZES** XS / S / M / L / XL  
**PRICE** € 50

00PE\_BLACK





reflective view

38PE\_GREY/REFLECTIVE

**NEW**

## REFLECTIVE THERMO GLOVES

REGULAR FIT THERMO REGULATION REFLECTIVE DETAILS

- REFLECTIVE DETAILS
- BREATHABLE
- STRETCH FABRIC
- MADE IN ITALY

85%PL - 15%EA

CODE 18WACRG  
 COLOR ● 38PE\_Grey/Reflective  
 SIZES S / M / L / XL  
 PRICE € 80



00\_BLACK

01\_WHITE

## FULLFINGER GLOVES

SLIM FIT THERMO REGULATION DRY FAST REFLECTIVE DETAILS

- LIGHTWEIGHT FABRIC
- PADDED LEATHER PALM FOR COMFORT AND PROTECTION
- MADE IN EU

80%PL - 20%EA

CODE 164ACGL  
 COLOR ● 00PE\_Black  
 ○ 01PE\_White  
 SIZES S / M / L / XL  
 PRICE € 50



00PE\_BLACK

07PE\_BLUE

13PE\_BORDEAUX

## THERMO GLOVES

REGULAR FIT WATER RESISTANT WIND PROOF THERMO REGULATION REFLECTIVE DETAILS

- WARM FABRIC
- SOFT TOUCH
- FLEECE LINING
- THERMAL & WIND RESISTANT PANELS
- MADE IN EU

85%PL - 15%EA

CODE 16WACGL  
 COLOR ● 00PE\_Black ● 07PE\_Blue  
 ● 13PE\_Bordeaux  
 SIZES S / M / L / XL  
 PRICE € 65



00PE\_BLACK

01PE\_WHITE

13PE\_BORDEAUX

07PE\_BLUE

15PE\_YELLOW

## LIGHTWEIGHT GLOVES

SLIM FIT REFLECTIVE DETAILS

- LIGHTWEIGHT FABRIC
- PADDED LEATHER PALM FOR COMFORT AND PROTECTION
- MADE IN EU

80%PL - 20%EA

CODE 16SACGL  
 COLOR ● 00PE\_Black ● 07PE\_Blue ● 13PE\_Bordeaux  
 ○ 01PE\_White ● 15PE\_Yellow  
 SIZES S / M / L / XL  
 PRICE € 39



00PE\_BLACK

## RAIN & WIND OVERSHOES



- WARM INSIDE FABRIC
- STRATEGIC REINFORCEMENT
- WINDPROOF PANELS
- MADE IN EU

100%PL

CODE 164ACOS

COLOR ● 00PE\_Black

SIZES S 35 - 39 / M 40 - 44 / L 45 - 48

PRICE € 60

## THERMO OVERSHOES



- WINDPROOF PANELS
- WARM FABRIC
- VIBRAM® GRIP SOLE MATERIAL
- MADE IN EU

86%PL - 14%EA

CODE 16WACOS

COLOR ● 00PE\_Black

SIZES S 35 - 39 / M 40 - 44 / L 45 - 48

PRICE € 65



00PE\_BLACK







00PE\_BLACK

01PE\_WHITE

# MERINO WINTER SOCKS



- DRY FAST & COMFORT
- SNUG FIT FOR SUPPORT
- REINFORCED TOE & HEEL
- MADE IN ITALY

65%WO - 20%PA - 15%EA

CODE 17WPSMS

COLOR ● 00PE\_Black  
● 01PE\_White

SIZES S 35 - 39 / M 40 - 44 / L 45 - 48

PRICE € 18



00PE\_BLACK

01PE\_WHITE

# MERINO SOCKS FLAG



- DRY FAST & COMFORT
- SNUG FIT FOR SUPPORT
- REINFORCED TOE & HEEL
- MADE IN ITALY

60%WO - 30%EA - 5%PP - 5%PA

CODE 17WMSFL

COLOR ● 00PE\_Black  
● 01PE\_White

SIZES S 35 - 39 / M 40 - 44 / L 45 - 48

PRICE € 18



00PE\_BLACK

01PE\_WHITE

07PE\_BLUE

# MERINO WINTER SOCKS POIS



- DRY FAST & COMFORT
- SNUG FIT FOR SUPPORT
- REINFORCED TOE & HEEL
- MADE IN ITALY

65%WO - 20%PA - 15%EA

CODE 17WPSMP

COLOR ● 00PE\_Black ● 07PE\_Blue  
● 01PE\_White

SIZES S 35 - 39 / M 40 - 44 / L 45 - 48

PRICE € 18



00PE\_BLACK

01PE\_WHITE

07PE\_BLUE

# BRITISH SOCKS



- DRY FAST & COMFORT
- SNUG FIT FOR SUPPORT
- REINFORCED TOE & HEEL
- MADE IN ITALY

85%PA - 15%EA

CODE 18SSJLT

COLOR ● 00PE\_Black ● 07PE\_Blue  
● 01PE\_White

SIZES S 35 - 39 / M 40 - 44 / L 45 - 48

PRICE € 16



## PRO SOCKS PLAIN



- DRY FAST & COMFORT
- SNUG FIT FOR SUPPORT
- REINFORCED TOE & HEEL
- MADE IN ITALY

60%WO - 20%PA - 15%EA

CODE 164PSPL

COLOR ● 00PE\_Black ● 07PE\_Blue  
 ● 01PE\_White ● 06PE\_Red

SIZES S 35 - 39 / M 40 - 44 / L 45 - 48

PRICE € 16



00PE\_BLACK 01PE\_WHITE 06PE\_RED 07PE\_BLUE



## PRO SOCKS BIG STRIPE



- DRY FAST & COMFORT
- SNUG FIT FOR SUPPORT
- REINFORCED TOE & HEEL
- MADE IN ITALY

20%PP - 13%VI - 13%CO - 53%PA - 1%EA

CODE 164PSBS

COLOR ● 00PE\_Black ● 07PE\_Blue  
 ● 06PE\_Red

SIZES S 35 - 39 / M 40 - 44 / L 45 - 48

PRICE € 16



00PE\_BLACK 06PE\_RED 07PE\_BLUE



## REFLECTIVE SOCKS ONE STRIPE



- REFLECTIVE
- DRY FAST & COMFORT
- SNUG FIT FOR SUPPORT
- REINFORCED TOE & HEEL
- MADE IN ITALY

55%WO - 30%EA - 5%PP - 5%PA

CODE 17WMS1S

COLOR ● 00PE\_Black ● 07PE\_Blue  
 ● 13PE\_Bordeaux

SIZES S 35 - 39 / M 40 - 44 / L 45 - 48

PRICE € 24



00PE\_BLACK 07PE\_BLUE 13PE\_BORDEAUX



## REFLECTIVE SOCKS THREE STRIPES



- REFLECTIVE
- DRY FAST & COMFORT
- SNUG FIT FOR SUPPORT
- REINFORCED TOE & HEEL
- MADE IN ITALY

55%WO - 30%EA - 5%PP - 5%PA

CODE 17WMS3S

COLOR ● 00PE\_Black ● 07PE\_Blue  
 ● 13PE\_Bordeaux

SIZES S 35 - 39 / M 40 - 44 / L 45 - 48

PRICE € 24



00PE\_BLACK 07PE\_BLUE 13PE\_BORDEAUX



07PE\_BLUE



15PE\_YELLOW 06PE\_RED 01PE\_WHITE 02PE\_GREY 12PE\_ORANGE

# HEIKO SOCKS



- DRY FAST & COMFORT
- SNUG FIT FOR SUPPORT
- REINFORCED TOE & HEEL
- MADE IN ITALY

65%WO - 20%PA - 15%EA

**CODE** 184SSHK  
**COLOR** ● 12PE\_Orange ● 15PE\_Yellow ● 01PE\_White  
 ● 02PE\_Grey ● 07PE\_Blue ● 06PE\_Red  
**SIZES** S 35 - 39 / M 40 - 44 / L 45 - 48  
**PRICE** € 13



800 ML

00PE\_BLACK

# MIZU WATERBOTTLE 800 ML



- DRY FAST & COMFORT
- SNUG FIT FOR SUPPORT
- REINFORCED TOE & HEEL
- MADE BY ELITE®

100%PE

**CODE** 164ACWB  
**COLOR** ● 00PE\_Black  
**SIZES** UNIQUE  
**PRICE** € 9



99PE\_MULTICOLOR



600 ML

00PE\_BLACK

# TEAM WATERBOTTLE 600 ML



- DRY FAST & COMFORT
- SNUG FIT FOR SUPPORT
- REINFORCED TOE & HEEL
- MADE BY ELITE®

100%PE

**CODE** 174AWB6  
**COLOR** 99PE\_Multicolor  
 ● 00PE\_Black  
**SIZES** UNIQUE  
**PRICE** € 9

designed in japan / made in italy



# JLT / CONDOR TEAM COLLECTION

☀️ SPRING/SUMMER   ❄️ FALL/WINTER

**PEdAL ED**



## JLT JERSEY



- 109 GRAMS
- ULTRA LIGHTWEIGHT AND BREATHABLE
- AERO CUT AND SEAMLESS SHOULDER FOR AERODYNAMICS
- COMPRESSION FIT FOR PERFORMANCE
- ASYMETRIC THREE REAR POCKETS FOR ADDITIONAL STORAGE
- MESH SIDE AND BACK PANELS FOR ADDITIONAL BREATHABILITY
- MADE IN ITALY

CODE 17SJSJL

COLOR ● 07PE\_Blue

SIZES XXS / XS / S / M / L / XL / XXL

PRICE € 135



## JLT BIBSHORT



- PANEL CONSTRUCTION FOR THE BEST FIT
- LIGHT AND HIGH-WICKING LYCRA® FABRIC UV PROTECTION
- OVAL BACK SUPPORT PROVIDES STABILITY
- MESH BACK PANELS ENHANCE BREATHABILITY
- FLAT SEAMS MOVE SMOOTHLY AGAINST YOUR SKIN FOR SUPPORT AND COMFORT
- BACTERIOSTATIC PAD BY ELASTIC INTERFACE®
- SLIM FIT FOR PERFORMANCE
- MADE IN ITALY

CODE 17SSPJL

COLOR ● 00PE\_Black

SIZES XXS / XS / S / M / L / XL / XXL

PRICE € 140



## JLT GILET



- WIND RESISTANT FABRIC FOR CHALLENGING CONDITIONS
- ULTRALIGHT AND PACKABLE
- STRETCH FABRIC FOR COMFORT
- ELASTICATED WAIST AND ARMHOLES
- REFLECTIVE PEDALED LOGO ON REAR
- SLIM FIT FOR PERFORMANCE
- MADE IN ITALY

CODE 174VEJL

COLOR ● 07PE\_Blue

SIZES XXS / XS / S / M / L / XL / XXL

PRICE € 95



## JLT CAP



- LIGHTWEIGHT AND DRY FAST
- ELASTIC HEADBAND PROVIDE A SNUG, COMFORTABLE FIT
- REGULAR FIT FOR COMFORT
- TEAM LOGO ON THE FRONT
- MADE IN ITALY

CODE 17SCAJL

COLOR ● 07PE\_Blue

SIZES UNIQUE

PRICE € 18

designed in japan / made in italy



☀️ SPRING/SUMMER ❄️ FALL/WINTER

**PEdAL ED**



05PE\_NAVY 13PE\_BORDEAUX 14PE\_BROWN 27PE\_PETROL

## SADDLE PACKABLE JACKET



- WATER RESISTANT
- WINDPROOF
- LIGHTWEIGHT & PACKABLE
- MADE IN ITALY

53%PA - 47%CO

CODE 164JKSD  
 COLOR ● 05PE\_Navy ● 27PE\_Petrol  
 ● 14PE\_Brown ● 13PE\_Bordeaux  
 SIZES XS / S / M / L / XL  
 PRICE € 230



00PE\_BLACK 07PE\_BLUE

## DISCOVERY SHELL JACKET



- WATERPROOF (10.000MM W/C)
- THERMO REGULATING & BREATHABLE
- STRETCH SOFTSHELL MATERIAL
- MADE IN ITALY

86%PA - 14%EA

CODE 154JKDS  
 COLOR ● 00PE\_Black ● 07PE\_Blue  
 SIZES S / M / L / XL  
 PRICE € 220



00PE\_BLACK 02PE\_GREY 03PE\_MILITARY G. 07PE\_BLUE 27PE\_PETROL

## ATTAKAI WOOL JACKET



- WOOL BLEND
- SHOULDER PROTECTION
- 2 BACK POCKET
- MADE IN ITALY

56%WO - 30%CO - 14%PA

CODE 16WJKWJ  
 COLOR ● 02PE\_Grey ● 07PE\_Blue ● 27PE\_Petrol  
 ● 03PE\_Military Green ● 00PE\_Black  
 SIZES XS / S / M / L / XL / XXL  
 PRICE € 160



07PE\_BLUE

## SHIRO URBAN JACKET



NEW



- WATERPROOF (10.000MM W/C)
- TAPED SEAMS
- BREATHABLE
- REFLECTIVE DETAILS
- 4 WATERPROOF VALUE POCKETS
- MADE IN ITALY

100%PES / 100%PU MEMBRANE

CODE 184JKSH  
 COLOR ● 07PE\_Blue  
 SIZES XS / S / M / L / XL / XXL  
 PRICE € 480



05PE\_NAVY



00PE\_BLACK 02PE\_GREY 03PE\_MIL\_GREEN 04PE\_BEIGE 07PE\_BLUE 13PE\_BORDEAUX

## TAGI MERINO PULLOVER



- FINE MERINO
- BREATHABLE
- ODOR CONTROL
- THERMO REGULATION
- MADE IN ITALY

100%WO

CODE 16WJSTA

COLOR ● 00PE\_Black ● 13PE\_Bordeaux ● 03PE\_Mil.Green  
● 02PE\_Grey ● 07PE\_Blue ● 04PE\_Beige ● 05PE\_Navy

SIZES XS / S / M / L / XL / XXL

PRICE € 160



00PE\_BLACK 02PE\_GREY 07PE\_BLUE

## KONCHA COTTON JACKET



- YKK ZIP SYSTEM
- SHOULDER PROTECTION
- 2 BACK POCKET
- MADE IN ITALY

90%CO - 10%PA

CODE 174JKKO

COLOR ● 00PE\_Black ● 07PE\_Blue  
● 02PE\_Grey

SIZES XS / S / M / L / XL / XXL

PRICE € 150



00PE\_BLACK 01PE\_WHITE 05PE\_NAVY

## GARAGE LINEN SHIRT



- LIGHTWEIGHT AND COMFORTABLE
- EASY-CARE QUICK-DRYING LINEN BODY
- CHEST POCKET FOR VALUABLES
- BACKSIDE STRETCH COTTON PANEL LETS YOU MOVE NATURALLY
- DROPPED BACK HEM ENHANCES COVERAGE WHILE RIDING
- UNDERARM INSETS FOR ENHANCED RANGE OF MOTION
- REGULAR FIT FOR COMFORT
- MADE IN ITALY

75%LI - 25%CO

CODE 15WSHGS

COLOR ● 00PE\_Black ● 05PE\_Navy  
● 01PE\_White

SIZES XS / S / M / L / XL

PRICE € 135



34PE\_PINK 12PE\_ORANGE 36PE\_LIME

## OSAKA RIDING POLO



- BACKSIDE ZIPPED POCKET
- BREATHABLE
- REGULAR FIT FOR RELAXED COMFORT
- MADE IN ITALY

100%CO

CODE 18SJSOP

COLOR ● 12PE\_Orange ● 36PE\_Lime  
● 34PE\_Pink

SIZES XS / S / M / L / XL

PRICE € 80





00PE\_BLACK 02PE\_GREY 05PE\_NAVY 13PE\_BORDEAUX

## TOKYO POLO LONG



- FINE COTTON
- BREATHABLE
- COMFORT FIT
- DRY FAST
- MADE IN ITALY

100%CO

CODE 17WJSPL

COLOR ● 00PE\_Black ● 05PE\_Navy  
● 02PE\_Grey ● 13PE\_Bordeaux

SIZES XS / S / M / L / XL

PRICE € 90



02PE\_GREY 05PE\_NAVY 13PE\_BORDEAUX

## TOKYO POLO



- FINE COTTON
- BREATHABLE
- COMFORT FIT
- DRY FAST
- MADE IN ITALY

100%CO

CODE 16SJSRP

COLOR ● 05PE\_Navy ● 13PE\_Bordeaux  
● 02PE\_Grey

SIZES S / M / L / XL

PRICE € 78



00PE\_BLACK 01PE\_WHITE 13PE\_BORDEAUX

## LOGO TEE



- CUT LONGER IN THE BACK
- COLOURED WITH NATURAL DYE
- RELAXED FIT
- MADE IN ITALY

100%CO

CODE 15WTSLO

COLOR ● 00PE\_Black ● 13PE\_Bordeaux  
● 01PE\_White

SIZES XXS / XS / S / M / L / XL / XXL

PRICE € 49



00PE\_BLACK 17PE\_CORAL RED 13PE\_BORDEAUX

## IKI MERINO T-SHIRT



- ULTRALIGHT WOOL
- BACK CUT FOR VENTILATION
- REFLECTIVE DETAILS
- MADE IN ITALY

67%WO - 22%PA - 11%EA

CODE 184TSIK

COLOR ● 00PE\_Black ● 13PE\_Bordeaux  
● 17PE\_Coral Red

SIZES XS / S / M / L / XL

PRICE € 70



09PE\_DENIM BLUE

## REFLECTIVE DENIM



- REFLECTIVE DETAILS
- BREATHABLE
- STRETCH FABRIC
- MADE IN JAPAN

97% COTTON - 3% ELASTANE

CODE 154LPRD

COLOR ● 09PE\_Denim Blue

SIZES 30 / 32 / 34 / 36 / 38

PRICE € 150



03PE\_MILITARY GREEN

04PE\_BEIGE

05PE\_NAVY

## CYCLING CHINOS



- COMFORT FIT & STRETCH FABRIC
- REFLECTIVE DETAILS
- CHAIN PROTECTION
- MADE IN ITALY

98%CO - 2%EA

CODE 164LPCC

COLOR ● 04PE\_Beige ● 05PE\_Navy

● 03PE\_Military Green

SIZES 28 / 30 / 32 / 34 / 36 / 38

PRICE € 99



00PE\_BLACK

37PE\_LIGHT GREEN

09PE\_DENIM BLUE

## CYCLING CHINOS SHORTS



- COMFORT FIT
- STRETCH FABRIC
- REFLECTIVE DETAILS
- MADE IN ITALY

98%CO - 2%EA

CODE 18SSPCC

COLOR ● 37PE\_Light Green ● 00PE\_Black

● 09PE\_Denim blue

SIZES 28 / 30 / 32 / 34 / 36 / 38

PRICE € 85



00PE\_BLACK



03PE\_MILITARY GREEN



06PE\_RED



00PE\_BLACK



06PE\_RED



07PE\_BLUE

## DARIO SOCKS SOLID



- DRY FAST & COMFORT
- SNUG FIT FOR SUPPORT
- REINFORCED TOE & HEEL
- MADE IN ITALY

20%PP DRYARN - 13%LENPUR - 53%PA - 13%CO - 1%EA

CODE 164WSON

COLOR ● 00PE\_Black ● 03PE\_Military Green  
● 06PE\_Red

SIZES S 35 - 39 / M 40 - 44 / L 45 - 48

PRICE € 15

## DARIO SOCKS DOT



- DRY FAST & COMFORT
- SNUG FIT FOR SUPPORT
- REINFORCED TOE & HEEL
- MADE IN ITALY

20%PP DRYARN - 13%LENPUR - 53%PA - 13%CO - 1%EA

CODE 164WSDO

COLOR ● 00PE\_Black ● 07PE\_Blue  
● 06PE\_Red

SIZES S 35 - 39 / M 40 - 44 / L 45 - 48

PRICE € 15



00PE\_BLACK



01PE\_WHITE



00PE\_BLACK



01PE\_WHITE CORDA



03PE\_MILITARY GREEN



14PE\_BROWN

## DARIO SOCKS FLAG



- DRY FAST & COMFORT
- SNUG FIT FOR SUPPORT
- REINFORCED TOE & HEEL
- MADE IN ITALY

20%PP DRYARN - 13%LENPUR - 53%PA - 13%CO - 1%EA

CODE 164WSFL

COLOR ● 00PE\_Black  
● 01PE\_White

SIZES S 35 - 39 / M 40 - 44 / L 45 - 48

PRICE € 15

## ELASTICA BELT



- STRETCH & ADJUSTABLE
- BROOKS SADDLE LEATHER INSERT
- REFLECTIVE DETAILS
- MADE IN ITALY

20%LT - 60%PO - 20%EL

CODE 154BEEL

COLOR ● 00PE\_Black ● 01PE\_White Corda  
● 14PE\_Brown ● 03PE\_Military Green

SIZES 100 cm / 120 cm

PRICE € 79



00PE\_BLACK 11PE\_GREEN 13PE\_BORDEAUX 14PE\_BROWN

## MIDO BOOTS



- WATER RESISTANT & BREATHABLE
- REFLECTIVE DETAILS
- ADDITIONAL 2 EXTRA LACES WITH REFLECTIVE
- MADE IN ITALY BY DIEMME

LEATHER AND RUBBER

CODE 15WSOWS  
 COLOR ● 00PE\_Black ● 13PE\_Bordeaux  
 ● 14PE\_Brown ● 11PE\_Green  
 SIZES 39 / 40 / 41 / 42 / 43 / 44 / 45  
 PRICE € 260



07PE\_BLUE/SUADE 03PE\_MIL. GREEN/SUADE

## MIDO BOOTS



- WATER RESISTANT
- BREATHABLE
- REFLECTIVE DETAILS
- 2 EXTRA LACES
- MADE IN ITALY BY DIEMME

LEATHER AND RUBBER

CODE 17WSOWS  
 COLOR ● 07PE\_Blue ● 03PE\_Military Green  
 SIZES 39 / 40 / 41 / 42 / 43 / 44 / 45  
 PRICE € 260



INTERNODE / 164ACBI



TENDRILL / 164ACBT



NODE / 164ACBN



CLUSTER 13 / 164ACBC

## BIKE PACKING BAGS



- CONSTRUCTION HELPS KEEP YOU DRY AND COMFORTABLE
- ARCH BRIDGE FOR A SUPPORTIVE, COMPRESSION FIT
- SNUG, COMPRESSION FIT FOR SUPPORT AND COMFORT
- INSTEP MESH PANELS FOR VENTILATION
- REINFORCED TOE AND HEEL FOR DURABILITY IN HIGH-WEAR AREAS
- LOW-FRICTION CONSTRUCTION FOR REDUCED ABRASION OVER THE HEEL AND TOES
- SLIM FIT FOR PERFORMANCE
- MADE IN ITALY

76%CO - 11% PU - 6%AC - 7%PA

MODEL	CODE	COLOR	SIZE	MEASURE	PRICE
INTERNODE	164ACBI	● 09PE_Denim	M	46/52 cm x 12 cm - volumes 4 liter	€ 105
CLUSTER 13	164ACBC	● 09PE_Denim	U	15x18x19 cm - volume 13 liters	€ 145
TENDRILL	164ACBT	● 09PE_Denim	U	diameter 18 cm - length 35 to 65 cm volume 17 liters	€ 115
NODE	164ACBN	● 09PE_Denim	U	length 24 cm - height 12, 5 cm width 6,5 cm	€ 55

designed in japan / made in italy



# WOMEN'S COLLECTION

 SPRING/SUMMER  FALL/WINTER

**PEdAL ED**



**NEW**

## HANE LIGHTWEIGHT JERSEY

- REGULAR FIT
- DRY FAST
- REFLECTIVE DETAILS

- ULTRA LIGHTWEIGHT
- REFLECTIVE DETAILS
- MADE IN ITALY

74%PL - 26%EA



00PE\_BLACK 10PE\_PURPLE 01PE\_WHITE

**CODE** W84JSHL  
**COLOR** ● 00PE\_Black ● 01PE\_White  
 ● 10PE\_Purple  
**SIZES** XXS / XS / S / M / L / XL  
**PRICE** € 150



**NEW**

## KAWA ESSENTIAL JERSEY

- REGULAR FIT
- DRY FAST
- REFLECTIVE DETAILS

- UV PROTECTION FABRIC
- BREATHABLE
- DRY FAST
- STRETCH FABRIC
- MADE IN ITALY

73%PA - 27%EA



05PE\_NAVY 17PE\_CORAL RED 39PE\_TURQUOISE

**CODE** W84JSKE  
**COLOR** ● 05PE\_Navy ● 39PE\_Turquoise  
 ● 17PE\_Coral Red  
**SIZES** XXS / XS / S / M / L / XL  
**PRICE** € 125



**NEW**

## HADA MERINO BASELAYER

- THERMO REGULATION
- DRY FAST

- MERINO WOOL
- BREATHABLE
- THERMO REGULATION
- MADE IN ITALY

67%WOO - 22%PA - 11%EA



00PE\_BLACK 17PE\_CORAL RED 10PE\_PURPLE

**CODE** W84JSMS  
**COLOR** ● 00PE\_Black ● 17PE\_Coral Red  
 ● 10PE\_Purple  
**SIZES** XXS / XS / S / M / L / XL  
**PRICE** € 60



**NEW**

## WOMEN ULTRALIGHT BSL

- DRY FAST

- DRY FAST
- BREATHABLE
- MADE IN ITALY

89%PP - 11%EA

**CODE** W8SJSUS  
**COLOR** ● 00PE\_Black  
**SIZES** XXS / XS / S / M / L / XL  
**PRICE** € 48

00PE\_BLACK



00PE\_BLACK



01PE\_WHITE

**NEW** **WOMAN VESPER VEST** 

- WINDPROOF
- REFLECTIVE DETAILS
- LIGHTWEIGHT GARMENT
- PACKABLE
- MADE IN ITALY

74%PL - 26%EA

**CODE** W8SVEVS  
**COLOR** ● 00PE\_Black  
 ● 01PE\_White  
**SIZES** XXS / XS / S / M / L / XL  
**PRICE** € 95



00PE\_BLACK



01PE\_WHITE

**NEW** **WOMAN VESPER JACKET**  

- WINDPROOF
- SLIMFIT FOR PERFORMANCE
- REFLECTIVE DETAILS
- LIGHTWEIGHT GARMENT
- PACKABLE
- MADE IN ITALY

73%PA - 27%EA

**CODE** W8WJKVS  
**COLOR** ● 00PE\_Black  
 ● 01PE\_White  
**SIZES** XXS / XS / S / M / L / XL  
**PRICE** € 108



00PE\_BLACK

**NEW** **TSUKI BIBSHORT** 

- UV PROTECTION FABRIC
- LASERCUT AND TAPE SEAMS
- BREATHABLE
- DRY FAST
- CYTECH® PADDING
- STRETCH FABRIC
- MADE IN ITALY

67%WOO - 22%PA - 11%EA

**CODE** W84BBTS  
**COLOR** ● 00PE\_Black  
**SIZES** XXS / XS / S / M / L / XL  
**PRICE** € 180



00PE\_BLACK

**NEW** **SHIZEN SHORTS** 

- UV PROTECTION FABRIC
- BREATHABLE
- DRY FAST
- CYTECH® PADDING
- STRETCH FABRIC
- MADE IN ITALY

89%PP - 11%EA

**CODE** W84BBSH  
**COLOR** ● 00PE\_Black  
**SIZES** XXS / XS / S / M / L / XL  
**PRICE** € 155



00PE\_BLACK 01PE\_WHITE 10PE\_PURPLE 17PE\_CORAL RED 05PE\_NAVY 39PE\_TURQUOISE

**NEW** **YUREI REGULAR SOCKS** ☀️

☑️ DRY FAST

- DRY FAST & COMFORT
- PERMANENT ANTIMICROBIAL PROPERTIES
- MADE IN ITALY

85%PA - 15%EL

**CODE** W84SRUY  
**COLOR** ● 00PE\_Black ● 10PE\_Purple ● 17PE\_Coral Red  
 ● 01PE\_White ● 05PE\_Navy ● 39PE\_Turquoise  
**SIZES** S 35 - 38 / M 39 - 42  
**PRICE** € 19



02PE\_GREY

**NEW** **WOMAN CYCLING CAP** ☀️

☑️ REGULAR FIT ☑️ DRY FAST

- COMFORT FIT & LIGHTWEIGHT
- MADE IN ITALY

100% POLYESTER

**CODE** W84CASC  
**COLOR** ● 02PE\_Grey  
**SIZES** UNIQUE  
**PRICE** € 20



00PE\_BLACK 01PE\_WHITE

**NEW** **YUREI SHORT SOCKS** ☀️

☑️ DRY FAST

- DRY FAST & COMFORT
- PERMANENT ANTIMICROBIAL PROPERTIES
- MADE IN ITALY

85%PA - 15%EL

**CODE** W8SSSYU  
**COLOR** ● 00PE\_Black  
 ● 01PE\_White  
**SIZES** S 35 - 38 / M 39 - 42  
**PRICE** € 14









# SADDLES

# FLEX + ROTATE

Since the introduction of Spine Concept in 2008 — fi'zi:k in collaboration with pro cyclists and the University of Colorado have made extensive studies to better understand the biomechanics of cycling in relation to comfort and performance. Introducing Spine Concept EVO an evolution in connectivity between rider and machine.

Seit der Einführung des Spine Concept in 2008 hat fi'zi:k gemeinsam mit professionellen Fahrern und der Universität in Colorado umfangreiche Studien betrieben, um noch mehr über die biomechanischen Abläufe während des Fahrens in Bezug auf Komfort und Performance zu verstehen. Herausgekommen ist das Spine Concept EVO, eine Evolution im Zusammenspiel von Fahrer und Maschine.

SPINE  
CONCEPT  
E V O

**FLEX + ROTATE.** Spine Flexibility and Pelvic Rotation are inextricably linked to saddle comfort and determine which saddle best fits you.

**FLEXIBILITÄT + ROTATION.** Flexibilität der Wirbelsäule und Rotationsfähigkeit des Beckens sind ausschlaggebend für Sitzkomfort und wesentliche Faktoren welcher Sattel am besten zu dir passt.



## SNAKE

High body flexibility and no pelvic rotation whilst pedalling. You need a flat saddle.  
Hohe Flexibilität im Körper und wenig Rotation im Becken beim pedalieren. Du benötigst einen möglichst flachen Sattel.

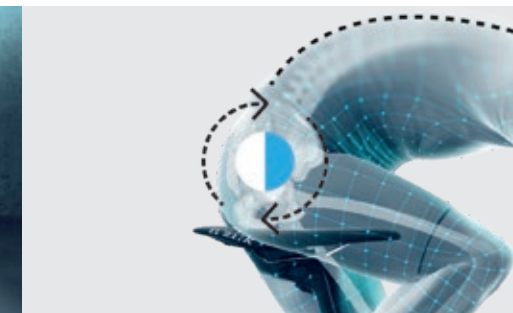

## BULL

Low body flexibility and high pelvic rotation whilst pedalling. You need a waved saddle.  
Geringe Flexibilität im Körper und viel Rotation im Becken beim pedalieren. Du benötigst einen geschwungenen Sattel.



## CHAMELEON

Medium body flexibility and low pelvic rotation whilst pedalling. You need an in-between saddle.  
Mittlere Flexibilität im Körper und wenig Rotation im Becken beim pedalieren. Du benötigst einen "in-between" Sattel.

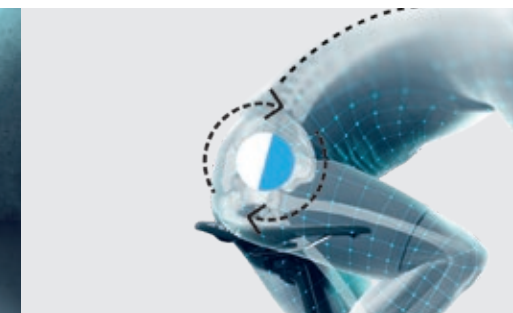

To calculate your size visit [www.fizik.com/spineconceptvo](http://www.fizik.com/spineconceptvo)  
 um deine Größe zu ermitteln gehe auf [www.fizik.com/spineconceptvo](http://www.fizik.com/spineconceptvo)

# WEIGHT + SPEED

**WEIGHT + TWO SPEED** . Your body weight and power output determine your saddle size: **Regular** or **Large**.

**GEWICHT + GESCHWINDIGKEIT**. "Anhand deines Körpergewichts und deiner Kraft wird deine Sattelgröße ermittelt: **Regular** oder **Large**."

80 kg

Your body weight / dein Körpergewicht

20 km/h

Your average speed on a flat road / deine Durchschnittsgeschwindigkeit in der Ebene

79 w / 33.9 kg

Power output - Weight on saddle / Leistung - Gewicht auf dem Sattel

**LARGE**

Your suggested saddle size / Deine empfohlene Sattel Größe

# TWO SIZES

TWO SIZES / ZWEI GRÖßEN



132 mm  
Arione Regular



142 mm  
Arione Large



142 mm  
Aliante Regular



152 mm  
Aliante Large



140 mm  
Antares Regular



152 mm  
Antares Large

# FIND YOUR SIZE

**FIND YOUR SIZE.** Select your body weight and average speed to determine your power output and suggested saddle size.

**Finde deine Größe.** Trage dein Gewicht und deine durchschnittliche Geschwindigkeit ein, um deine abgegebene Leistung und deine empfohlene Sattelgröße zu ermitteln.



Together with the **Spine Concept EVO** display, fi'zi:k have developed a dedicated Spine Concept EVO App to support and assist you with in-store sales. How to download and use it? Simply visit the iTunes App Store (iOS devices) or from the Google Play Store (Android devices), search for the keywords: **spine concept evo and/or fi'zi:k, and download.**

Passend zu dem **Spine Concept EVO** Display, hat fi'zi:k eine abgestimmte Spine Concept EVO App entwickelt, um bei in-Store Verkäufen unterstützend mitzuwirken. Wo diese zu finden ist? Besuche einfach den iTunes App Store (iOS Geräte) oder den Google Play Store (Android Geräte) und suche nach: **spine concept evo und/oder fi'zi:k, und drücke auf download.**

Suggested size is /die empfohlene Größe lautet: **Regular**  
 Suggested size is /die empfohlene Größe lautet: **Large**

Speed in km/h	20	21	22	23	24	25	26	27	28	29	30	31	32	33	34	35	36	37	38	39	40	41	42	43	44	45
Speed in mph	12.5	13	13.6	14.3	14.9	15.5	16	16.7	17.4	18	18.6	19.2	19.9	20.5	21	21.7	22.4	23	23.5	24	25	25.5	26	26.5	27.3	28
45 kg	64W 18.4kg	71W 18.2kg	78W 18.0kg	86W 17.7kg	95W 17.4kg	104W 17.1kg	114W 16.8kg	125W 16.4kg	137W 16.1kg	149W 15.7kg	162W 15.3kg	174W 14.8kg	190W 14.3kg	205W 13.8kg	222W 13.3kg	239W 12.8kg	257W 12.2kg	276W 11.6kg	296W 10.9kg	317W 10.2kg	339W 9.5kg	362W 8.8kg	387W 8.0kg	412W 7.1kg	438W 6.3kg	466W 5.4kg
50 kg	66W 20.6kg	74W 20.4kg	81W 20.1kg	89W 19.9kg	98W 19.6kg	108W 19.3kg	118W 19.0kg	129W 18.6kg	140W 18.2kg	153W 17.8kg	166W 17.4kg	180W 17.0kg	194W 16.5kg	210W 16.0kg	226W 15.4kg	244W 14.9kg	262W 14.3kg	281W 13.7kg	301W 13.0kg	323W 12.3kg	345W 11.6kg	368W 10.9kg	392W 10.1kg	418W 9.2kg	444W 8.4kg	472W 7.5kg
55 kg	69W 22.8kg	76W 22.6kg	84W 22.3kg	93W 22.1kg	102W 21.8kg	111W 21.4kg	122W 21.1kg	133W 20.8kg	144W 20.4kg	157W 20.0kg	170W 19.5kg	184W 19.1kg	199W 18.6kg	214W 18.1kg	231W 17.6kg	248W 17.0kg	267W 16.4kg	286W 15.8kg	306W 15.1kg	328W 14.4kg	350W 13.7kg	374W 12.9kg	398W 12.2kg	424W 11.3kg	450W 10.5kg	478W 9.6kg
60 kg	72W 25.0kg	79W 24.8kg	87W 24.5kg	96W 24.2kg	105W 23.9kg	115W 23.6kg	125W 23.3kg	136W 22.9kg	148W 22.5kg	161W 22.1kg	174W 21.7kg	188W 21.2kg	203W 20.7kg	219W 20.2kg	236W 19.7kg	253W 19.1kg	272W 18.5kg	291W 17.9kg	312W 17.2kg	333W 16.5kg	356W 15.8kg	379W 15.0kg	404W 14.2kg	430W 13.4kg	456W 12.5kg	485W 11.6kg
65 kg	75W 27.2kg	82W 26.9kg	90W 26.7kg	99W 26.4kg	108W 26.1kg	118W 25.8kg	129W 25.4kg	140W 25.1kg	152W 24.7kg	165W 24.3kg	178W 23.8kg	192W 23.4kg	207W 22.9kg	223W 22.4kg	240W 21.8kg	258W 21.2kg	277W 20.6kg	296W 20.0kg	317W 19.3kg	338W 18.6kg	361W 17.9kg	385W 17.1kg	410W 16.3kg	435W 15.5kg	462W 14.6kg	491W 13.7kg
70 kg	77W 29.4kg	85W 29.1kg	93W 28.9kg	102W 28.6kg	111W 28.3kg	121W 28.0kg	132W 27.6kg	144W 27.2kg	156W 26.8kg	169W 26.4kg	182W 26.0kg	197W 25.5kg	212W 25.0kg	228W 24.5kg	245W 24.0kg	263W 23.4kg	282W 22.8kg	301W 22.1kg	322W 21.5kg	344W 20.7kg	367W 20.0kg	390W 19.2kg	415W 18.4kg	441W 17.6kg	468W 16.7kg	497W 15.8kg
75 kg	80W 31.6kg	88W 31.3kg	96W 31.0kg	105W 30.8kg	115W 30.4kg	125W 30.1kg	136W 29.8kg	147W 29.4kg	159W 29.0kg	172W 28.6kg	186W 28.1kg	201W 27.7kg	216W 27.2kg	232W 26.6kg	250W 26.1kg	268W 25.5kg	286W 24.9kg	306W 24.2kg	327W 23.5kg	349W 22.9kg	372W 22.1kg	396W 21.3kg	421W 20.5kg	447W 19.7kg	474W 18.8kg	503W 17.9kg
80 kg	83W 33.8kg	91W 33.5kg	99W 33.2kg	108W 32.9kg	118W 32.6kg	128W 32.3kg	139W 31.9kg	151W 31.5kg	163W 31.1kg	176W 30.7kg	190W 30.3kg	205W 29.8kg	221W 29.3kg	237W 28.8kg	254W 28.2kg	272W 27.6kg	291W 27.0kg	311W 26.4kg	332W 25.7kg	354W 25.0kg	377W 24.2kg	402W 23.4kg	427W 22.6kg	453W 21.8kg	480W 20.9kg	509W 19.9kg
85 kg	85W 35.9kg	94W 35.7kg	102W 35.4kg	111W 35.1kg	121W 34.8kg	132W 34.5kg	143W 34.1kg	155W 33.7kg	167W 33.3kg	180W 32.9kg	194W 32.4kg	209W 31.9kg	225W 31.4kg	241W 30.9kg	259W 30.3kg	277W 29.7kg	296W 29.1kg	316W 28.5kg	338W 27.8kg	360W 27.1kg	383W 26.3kg	407W 25.5kg	432W 24.7kg	459W 23.9kg	486W 23.0kg	515W 22.0kg
90 kg	88W 38.1kg	96W 37.9kg	105W 37.6kg	115W 37.3kg	124W 37.0kg	135W 36.6kg	146W 36.3kg	158W 35.9kg	171W 35.5kg	184W 35.0kg	199W 34.6kg	213W 34.1kg	229W 33.6kg	246W 33.0kg	263W 32.5kg	282W 31.9kg	301W 31.2kg	321W 30.6kg	343W 29.9kg	365W 29.2kg	388W 28.4kg	413W 27.6kg	438W 26.8kg	465W 25.9kg	492W 25.0kg	521W 24.1kg
95 kg	91W 40.3kg	99W 40.1kg	108W 39.8kg	118W 39.5kg	128W 39.2kg	138W 38.8kg	150W 38.4kg	162W 38.0kg	175W 37.6kg	188W 37.2kg	203W 36.7kg	218W 36.2kg	234W 35.7kg	250W 35.2kg	268W 34.6kg	287W 34.0kg	306W 33.4kg	327W 32.7kg	348W 32.0kg	370W 31.3kg	394W 30.5kg	418W 29.7kg	444W 28.9kg	471W 28.0kg	498W 27.1kg	527W 26.2kg
100 kg	94W 42.5kg	102W 42.4kg	110W 42.1kg	119W 41.8kg	129W 41.5kg	139W 41.1kg	150W 40.7kg	162W 40.4kg	175W 39.9kg	188W 39.5kg	203W 39.0kg	218W 38.6kg	234W 38.0kg	250W 37.5kg	268W 36.9kg	287W 36.3kg	306W 35.7kg	327W 35.0kg	348W 34.3kg	370W 33.6kg	394W 32.9kg	418W 32.1kg	444W 31.2kg	471W 30.4kg	498W 29.5kg	527W 28.5kg
110 kg	99W 46.9kg	108W 46.6kg	117W 46.3kg	127W 46.0kg	137W 45.6kg	147W 45.3kg	158W 44.9kg	169W 44.5kg	181W 44.1kg	194W 43.6kg	208W 43.1kg	223W 42.6kg	239W 42.1kg	255W 41.6kg	272W 41.1kg	290W 40.4kg	308W 39.7kg	327W 39.0kg	346W 38.3kg	365W 37.6kg	384W 36.8kg	403W 36.0kg	422W 35.2kg	441W 34.3kg	460W 33.4kg	479W 32.4kg
120 kg	105W 51.3kg	114W 51.0kg	123W 50.7kg	133W 50.3kg	144W 50.0kg	155W 49.6kg	166W 49.2kg	178W 48.8kg	190W 48.4kg	203W 47.9kg	217W 47.4kg	232W 46.9kg	247W 46.4kg	263W 45.8kg	279W 45.2kg	295W 44.6kg	311W 43.9kg	327W 43.3kg	344W 42.5kg	360W 41.8kg	377W 41.0kg	394W 40.2kg	411W 39.4kg	428W 38.5kg	445W 37.5kg	462W 36.6kg

**SPINE CONCEPT EVO**

31.7 kg  
Bodyweight on saddle  
Rider 75 kg  
Power Output 1 w/kg

40%  
Bodyweight distribution  
Rider 75 kg  
Power Output 2 w/kg

15%  
Bodyweight distribution  
Rider 75 kg  
Power Output 3.5 w/kg

45%  
Bodyweight on saddle  
Rider 75 kg  
Power Output 5.5 w/kg

# SURFACE CHOICE

**Like with all saddles it's personal.**

And having the ability to choose their surface type is an option we feel all our consumers deserve.

**Ein Sattel ist etwas persönliches.**

Und wir finden dass unsere Kunden die Möglichkeit haben sollten, sich dabei eine Sitzfläche nach ihrem Geschmack aussuchen zu dürfen.

**SOLID**

Solid surface are pro peloton proven saddles engineered for race performance. This handmade construction provides a stiff interface tuned for optimal power transfer combined with a resilient foam cushioning for even distribution of body weight.

Eine, wie sie oftmals im Pro Peloton gefahren wird, geschlossene Sitzfläche, für Rennperformance entwickelt. Diese handgefertigte Konstruktion bietet eine steife Fläche abgestimmt auf eine optimale Kraftübertragung kombiniert mit einem elastischen Schaumpolster für eine gleichmäßige Verteilung des Körpergewichts.

**VERSUS EVO**

Versus Evo are saddles designed to complement nowadays versatile, efficient and all-purpose, all-road machines. The controlled elasticity of the shell and the progressive cushioning allow the rider to perform in comfort for longer and everywhere.

Die Versus Evo Sättel wurden designt um die modernen, vielseitigen, effizienten All-Road Maschinen zu ergänzen. Die kontrollierte Elastizität der Schale und die progressive Polsterung bieten dem Fahrer mehr Komfort um seine Performance über einen längeren Zeitraum abzurufen, egal wo.

**OPEN**

Open are race-bred saddles built with a central cutout for perineal pressure relief. This handmade construction provides a stiff interface tuned for maximum power transfer combined with a resilient foam cushioning and a cutaway design that relief pressure on soft tissue.

Open Sättel wurden in Rennen hervorgebracht. Der Cutout im Mittelteil sorgt dabei für Druckentlastung. Diese handgefertigte Konstruktion bietet eine steife Fläche für eine maximale Kraftübertragung kombiniert mit einem elastischen Polster und einem für Entlastung sorgendem Ausschnitt.



**Arione**  
Made for Snake



**Antares**  
Made for Chameleon



**Aliante**  
Made for Bull



**Arione 00**  
Made for Snake

length 298 | width 124 mm



code	EAN	color (main/trim)	rail	shell	tech	weight	SRP
7092SWSA19C65	8021890428127	Black/Anthracite	Carbon Braided 7x9 Mobius	Carbon double	Wing Flex	140 g	350 €

**Arione R1**  
Made for SnakeRegular | length 304 | width 126 mm  
Large | length 300 | width 140 mm

Regular

Large

code	EAN	color (main/trim)	rail	shell	tech	weight	SRP
76B5SWSA09C65	8021890443861	Black/Black	Carbon Braided 7x9	Composite Carbon co-injected Nylon	Wing Flex	165 g	199 €
76B0SWSA09E12	8021890443830	Black/Black	Carbon Braided 7x9	Composite Carbon co-injected Nylon	Wing Flex	175 g	199 €

**Arione R3**  
Made for SnakeRegular | length 304 | width 126 mm  
Large | length 300 | width 141 mm

Regular

Large

code	EAN	color (main/trim)	rail	shell	tech	weight	SRP
74B5SWSA09F04	8021890443816	Black/Black/White	k:iium	Composite Glass co-injected Nylon	Wing Flex	200 g	149 €
74B0SWSA09C65	8021890443786	Black/Black/White	k:iium	Composite Glass co-injected Nylon	Wing Flex	210 g	149 €

**Arione**  
Made for Snake

length 302 | width 131 mm



code	EAN	color (main/trim)	rail	shell	tech	weight	SRP
7014XSXD99640	8021890276308	Alcantara Black/Black	k:iium	Carbon Reinforced Nylon	Wing Flex	235 g	129 €

**Arione 00 Versus EVO** **NEW**  
Made for SnakeRegular | length 299 | width 130 mm  
Large | length 299 | width 140 mm

Regular

Large

code	EAN	color (main/trim)	rail	shell	tech	weight	SRP
77A4SOSA03A23	8021890469175	Black	Carbon Braided 7x9 Mobius	High Module Full Carbon	Wing Flex	166 g	350 €
77D4SOSA03A23	8021890469205	Black	Carbon Braided 7x9 Mobius	High Module Full Carbon	Wing Flex	169 g	350 €

**Arione R1 Versus EVO**  
Made for SnakeRegular | length 299 | width 130 mm  
Large | length 299 | width 139 mm

Regular

Large

code	EAN	color (main/trim)	rail	shell	tech	weight	SRP
70A4SOSA03A02	8021890455574	Black	Carbon Braided 7x9 Mobius	Carbon Reinforced Nylon	Wing Flex	185 g	210 €
70D4SOSA03A02	8021890455765	Black	Carbon Braided 7x9 Mobius	Carbon Reinforced Nylon	Wing Flex	189 g	210 €

**Arione R3 Versus EVO**  
Made for SnakeRegular | length 299 | width 129 mm  
Large | length 297 | width 140 mm

Regular

Large

code	EAN	color (main/trim)	rail	shell	tech	weight	SRP
70A4SOSA13041	8021890455581	Black	k:iium	Carbon Reinforced Nylon	Wing Flex	225 g	160 €
70D4SOSA13041	8021890455772	Black	k:iium	Carbon Reinforced Nylon	Wing Flex	229 g	160 €

ROAD



**Arione R1 Open**  
Made for Snake

Regular | lenght 300 | width 132 mm  
Large | lenght 298 | width 142 mm



code	EAN	color (main/trim)	rail	shell	tech	weight	SRP
70C0S A03A02	8021890455642	Black	Carbon Braided 7x9 Mobius	Carbon Reinforced Nylon	Wing Flex	199 g	179 €
70D0S A03A02	8021890455703	Black	Carbon Braided 7x9 Mobius	Carbon Reinforced Nylon	Wing Flex	205 g	179 €



**Arione R3 Open**  
Made for Snake



code	EAN	color (main/trim)	rail	shell	tech	weight	SRP
70C0S A13041	8021890455659	Black	k:i:um	Carbon Reinforced Nylon	Wing Flex	230 g	139 €
70D0S A13041	8021890455710	Black	k:i:um	Carbon Reinforced Nylon	Wing Flex	240 g	139 €
<b>NEW</b> 70C0S A13038	8021890460233	White Edition	k:i:um	Carbon Reinforced Nylon	Wing Flex	230 g	139 €
<b>NEW</b> 70D0S A13038	8021890460264	White Edition	k:i:um	Carbon Reinforced Nylon	Wing Flex	240 g	139 €







### Antares 00

Made for Chameleon

length 275 | width 140 mm



code	EAN	color (main/trim)	rail	shell	tech	weight	SRP
7091SWSA19C65	8021890428103	Black/Anthracite	Carbon Braided 7x9 Mobius	Carbon double	Wing Flex	140 g	350 €



### Antares R1

Made for Chameleon

Regular | length 275 | width 141 mm  
Large | length 275 | width 152 mm

code	EAN	color (main/trim)	rail	shell	tech	weight	SRP
7683SXSA69E12	8021890443878	Black/Black	Carbon Braided 7x9	Composite Carbon co-injected Nylon	Wing Flex	160 g	199 €
76B1SXSA09C65	8021890443847	Black/Black	Carbon Braided 7x9	Composite Carbon co-injected Nylon	Wing Flex	165 g	199 €



### Antares R3

Made for Chameleon



code	EAN	color (main/trim)	rail	shell	tech	weight	SRP
7483SXSB89H16	8021890443823	Black/Black	k:i:um	Composite Glass co-injected Nylon	Wing Flex	200 g	149 €
74B1SXSA09C65	8021890443793	Black/Black	k:i:um	Composite Glass co-injected Nylon	Wing Flex	205 g	149 €



### Antares 00 Versus EVO **NEW**

Made for Chameleon

Regular | length 274,5 | width 137,5 mm  
Large | length 274 | width 147 mm

code	EAN	color (main/trim)	rail	shell	tech	weight	SRP
77A5SOSA03A23	8021890469182	Black	Carbon Braided 7x9 Mobius	High Module Full Carbon	Wing Flex	153 g	350 €
77D5SOSA03A23	8021890469212	Black	Carbon Braided 7x9 Mobius	High Module Full Carbon	Wing Flex	159 g	350 €



### Antares R1 Versus EVO

Made for Chameleon

Regular | length 273 | width 139 mm  
Large | length 275 | width 149 mm

code	EAN	color (main/trim)	rail	shell	tech	weight	SRP
70A5SOSA03A02	8021890455598	Black	Carbon Braided 7x9 Mobius	Carbon Reinforced Nylon	Wing Flex	179 g	210 €
70D5SOSA03A02	8021890455789	Black	Carbon Braided 7x9 Mobius	Carbon Reinforced Nylon	Wing Flex	185 g	210 €



### Antares R3 Versus EVO

Made for Chameleon

Regular | length 274 | width 139 mm  
Large | length 274 | width 148 mm

code	EAN	color (main/trim)	rail	shell	tech	weight	SRP
70A5SOSA13041	8021890455604	Black	k:i:um	Carbon Reinforced Nylon	Wing Flex	215 g	160 €
70D5SOSA13041	8021890455796	Black	k:i:um	Carbon Reinforced Nylon	Wing Flex	220 g	160 €

ROAD



**Antares R1 Open**  
Made for Chameleon

Regular | lenght 276 | width 141 mm  
Large | lenght 276 | width 153 mm



code	EAN	color (main/trim)	rail	shell	tech	weight	SRP
70C1S A03A02	8021890455666	Black	Carbon Braided 7x9 Mobius	Carbon Reinforced Nylon	Wing Flex	185 g	179 €
70D1S A03A02	8021890455727	Black	Carbon Braided 7x9 Mobius	Carbon Reinforced Nylon	Wing Flex	190 g	179 €



**Antares R3 Open**  
Made for Chameleon

Regular | lenght 276 | width 142 mm  
Large | lenght 276 | width 153 mm



code	EAN	color (main/trim)	rail	shell	tech	weight	SRP
70C1S A13041	8021890455673	Black	k:i:um	Carbon Reinforced Nylon	Wing Flex	215 g	139 €
70D1S A13041	8021890455734	Black	k:i:um	Carbon Reinforced Nylon	Wing Flex	220 g	139 €
<b>NEW</b> 70C1S A13038	8021890460240	White Edition	k:i:um	Carbon Reinforced Nylon	Wing Flex	215 g	139 €
<b>NEW</b> 70D1S A13038	8021890460288	White Edition	k:i:um	Carbon Reinforced Nylon	Wing Flex	220 g	139 €



ROAD



**Aliante 00**  
Made for Bull

length 277 | width 134 mm



code	EAN	color (main/trim)	rail	shell	tech	weight	SRP
7093SWSA19C65	8021890428141	Black/Anthracite	Carbon Braided 7x9 Mobius	Carbon double	Wing Flex	165 g	350 €



**Aliante R1**  
Made for Bull

Regular | length 279 | width 138 mm  
Large | length 279 | width 154 mm



code	EAN	color (main/trim)	rail	shell	tech	weight	SRP
7680SWSA09F75	8021890411280	Black/Black	Carbon Braided 7x9	Composite Carbon co-injected Nylon	Twin Flex	175 g	199 €
76B2SWSA09F81	8021890443854	Black/Black	Carbon Braided 7x9	Composite Carbon co-injected Nylon	Twin Flex	180 g	199 €



**Aliante R3**  
Made for Bull

Regular | length 279 | width 138 mm  
Large | length 279 | width 155 mm



code	EAN	color (main/trim)	rail	shell	tech	weight	SRP
7480SWSA79F82	8021890444080	Black/Black	k:i:um	Composite Glass co-injected Nylon	Twin Flex	215 g	149 €
74B2SWSA09F75	8021890443809	Black/Black	k:i:um	Composite Glass co-injected Nylon	Twin Flex	220 g	149 €



**Aliante Gamma**  
Made for Bull

length 266 | width 141 mm



code	EAN	color (main/trim)	rail	shell	tech	weight	SRP
7018SWSA49A62	8021890348371	Black/White	k:i:um	Carbon Reinforced Nylon	Twin Flex	255 g	129 €

ROAD



**Aliante 00 Versus EVO** **NEW**  
Made for Bull

Regular | length 281,5 | width 135,5 mm  
Large | length 281,5 | width 150 mm



code	EAN	color (main/trim)	rail	shell	tech	weight	SRP
77A6SOSA03A23	8021890469199	Black	Carbon Braided 7x9 Mobius	High Module Full Carbon	Wing Flex	163 g	350 €
77D6SOSA03A23	8021890469229	Black	Carbon Braided 7x9 Mobius	High Module Full Carbon	Wing Flex	169 g	350 €



**Aliante R1 Versus EVO**  
Made for Bull

Regular | length 280 | width 139 mm  
Large | length 280 | width 169 mm



code	EAN	color (main/trim)	rail	shell	tech	weight	SRP
70A6SOSA03A02	8021890455611	Black	Carbon Braided 7x9 Mobius	Carbon Reinforced Nylon	Wing Flex	189 g	210 €
70D6SOSA03A02	8021890455802	Black	Carbon Braided 7x9 Mobius	Carbon Reinforced Nylon	Wing Flex	195 g	210 €



**Aliante R3 Versus EVO**  
Made for Bull

Regular | length 280 | width 139 mm  
Large | length 279 | width 153 mm



code	EAN	color (main/trim)	rail	shell	tech	weight	SRP
70A6SOSA13041	8021890455628	Black	k:i:um	Carbon Reinforced Nylon	Wing Flex	229 g	160 €
70D6SOSA13041	8021890455819	Black	k:i:um	Carbon Reinforced Nylon	Wing Flex	235 g	160 €

ROAD



**Aliante R1 Open**  
Made for Bull

Regular | lenght 276 | width 141 mm  
Large | lenght 275 | width 153 mm



code	EAN	color (main/trim)	rail	shell	tech	weight	SRP
70C2S A03A02	8021890455680	Black	Carbon Braided 7x9 Mobius	Carbon Reinforced Nylon	Wing Flex	199 g	179 €
70D2S A03A02	8021890455741	Black	Carbon Braided 7x9 Mobius	Carbon Reinforced Nylon	Wing Flex	205 g	179 €



**Aliante R3 Open**  
Made for Bull

Regular | lenght 278 | width 142 mm  
Large | lenght 278 | width 152 mm



code	EAN	color (main/trim)	rail	shell	tech	weight	SRP
70C2S A13041	8021890455697	Black	k:i:um	Carbon Reinforced Nylon	Wing Flex	235 g	139 €
70D2S A13041	8021890455758	Black	k:i:um	Carbon Reinforced Nylon	Wing Flex	245 g	139 €
<b>NEW</b> 70C2S A13038	8021890460257	White Edition	k:i:um	Carbon Reinforced Nylon	Wing Flex	235 g	139 €
<b>NEW</b> 70D2S A13038	8021890460301	White Edition	k:i:um	Carbon Reinforced Nylon	Wing Flex	245 g	139 €



## X-ROAD

### MONTE Made for Enduro

length 277 | width 143 mm



code	EAN	color (main/trim)	rail	shell	tech	weight	SRP
70A0SXCA29878	8021890443885	Black/Black Cordura	S-Alloy	Carbon Reinforced Nylon	Tail Flex	250 g	79 €

### Tundra M1 Made for Cross Country

length 287 | width 126 mm



code	EAN	color (main/trim)	rail	shell	tech	weight	SRP
7682SWSA09E12	8021890391568	Black/Black	Carbon Braided 7x9	Composite Carbon co-injected Nylon	Wing Flex	160 g	199 €

### Tundra M3 Made for Cross Country

length 286 | width 126 mm



code	EAN	color (main/trim)	rail	shell	tech	weight	SRP
7482SWSA69C65	8021890448132	Black/Grey	k:i:um	Composite Glass co-injected Nylon	Wing Flex	200 g	149 €

### Tundra M5 VS Made for Cross Country

length 287 | width 126 mm



code	EAN	color (main/trim)	rail	shell	tech	weight	SRP
7094SXCA29878	8021890443991	Black/Silver	S-Alloy	Carbon Reinforced Nylon	Wing Flex	235 g	99 €

## X-ROAD

### Gobi M1 Made for All Mountain and Marathon

length 286 | width 128 mm



code	EAN	color (main/trim)	rail	shell	tech	weight	SRP
7665SWSA09G02	8021890413802	Black/Black	Carbon Braided 7x9	Composite Carbon	Wing Flex, Tail Flex	170 g	199 €

### Gobi M3 Made for All Mountain and Marathon



code	EAN	color (main/trim)	rail	shell	tech	weight	SRP
7465SWSA39G04	8021890444073	Black/Grey	k:i:um	Composite Glass co-injected Nylon	Wing Flex, Tail Flex	200 g	149 €

### Gobi M5 VS Made for All Mountain and Marathon



code	EAN	color (main/trim)	rail	shell	tech	weight	SRP
7096SXCA29878	8021890444004	Black/Silver	S-Alloy	Carbon Reinforced Nylon	Wing Flex, Tail Flex	240 g	99 €

## TRANSIRO

### Transiro Mistica Carbon + CARRIAGE KIT



NEW

Regular | width 134 mm | width nose 55 mm  
Large | width 139 mm | width nose 65 mm



Regular



Large



code	EAN	color (main/trim)	rail	shell	tech	weight	SRP
70B6SWSA29H20	8021890468925	Black/White	Carbon Braided 7x9	Carbon Reinforced Nylon, extra grip cover	Nose less	205 g	250 €
70B7SWSA29H20	8021890468949	Black/White	Carbon Braided 7x9	Carbon Reinforced Nylon, extra grip cover	Nose less	215 g	250 €

### Transiro Mistica k:i:um + CARRIAGE KIT



NEW



Regular



Large



code	EAN	color (main/trim)	rail	shell	tech	weight	SRP
70B6SWSA39H19	8021890468932	Black/Black	k:i:um	Carbon Reinforced Nylon, extra grip cover	Nose less	235 g	179 €
70B7SWSA39H19	8021890468956	Black/Black	k:i:um	Carbon Reinforced Nylon, extra grip cover	Nose less	245 g	179 €



## WOMEN

### Luce R1

Made for Road

Regular | lenght 280 | width 145 mm  
Large | lenght 281 | width 155 mm



code	EAN	color (main/trim)	rail	shell	tech	weight	SRP
70B3SWSA39E12	8021890455994	Black	Carbon Braided 7x9	Carbon Reinforced Nylon	Ischial Flex	195 g	179 €
70B4SWSA39E12	8021890456014	Black	Carbon Braided 7x9	Carbon Reinforced Nylon	Ischial Flex	199 g	179 €

### Luce R5

Made for Road

Regular | lenght 281 | width 145 mm  
Large | lenght 281 | width 156 mm



code	EAN	color (main/trim)	rail	shell	tech	weight	SRP
70B3SWSA49C65	8021890456007	Black	S-Alloy	Carbon Reinforced Nylon	Ischial Flex	250 g	99 €
70B4SWSA49C65	8021890456021	Black	S-Alloy	Carbon Reinforced Nylon	Ischial Flex	255 g	99 €

### Luna X5

Made for MTB

Regular | lenght 281 | width 145 mm  
Large | lenght 281 | width 156 mm



code	EAN	color (main/trim)	rail	shell	tech	weight	SRP
70C7SWSA09604	8021890456038	Black	S-Alloy	Carbon Reinforced Nylon	Ischial Flex	255 g	99 €
70C8SWSA09604	8021890456045	Black	S-Alloy	Carbon Reinforced Nylon	Ischial Flex	260 g	99 €







SHOES

# INFINITO—R1

## PERFECT. PERFECTED.

The Infinito R1 shoe provides an adaptive, lightweight fit thanks to the innovative Dynamic Arch Support empowered by Volume Control.

PERFEKTION.PERFEKTIONIERT. Dank des innovativen Dynamic Arch Support bietet der leichtgewichtige Infinito R1 eine adaptive Passform, begünstigt durch Volume Control.

fi'zi:k

VOLUME:CONTROL

## ROAD

### Infinito R1 Movistar Team



code	EAN	size	color	outsole	insole	closure	upper material	SRP
R1INFIN18-MO43	Various	37-47	Movistar Light Blue	UD Vented Carbon	fi'zi:k Cycling Insole	Boa IP1-B	Micotex Laser Perforated	380 €

### Infinito R1 Knit



code	EAN	size	color	outsole	insole	closure	upper material	SRP
R1INFIN18-1060	Various	37-48	Black Knitted	UD Vented Carbon	fi'zi:k Cycling Insole	Boa IP1-B	Knitted	380 €
<b>NEW</b> R1INFIN18-7310	Various	40-46	Grey Knit/Black	UD Vented Carbon	fi'zi:k Cycling Insole	Boa IP1-B	Knitted	380 €
<b>NEW</b> R1INFIN18-4490	Various	40-46	Petroleum Blue Knit/ Yellow Fluo	UD Vented Carbon	fi'zi:k Cycling Insole	Boa IP1-B	Knitted	380 €

### Infinito R1



code	EAN	size	color	outsole	insole	closure	upper material	SRP
R1INFIN18-1010	Various	37-48	Black/Black	UD Vented Carbon	fi'zi:k Cycling Insole	Boa IP1-B	Micotex Laser Perforated	350 €
R1INFIN18-2010	Various	37-48	White/Black	UD Vented Carbon	fi'zi:k Cycling Insole	Boa IP1-B	Micotex Laser Perforated	350 €
R1INFIN18-3010	Various	37-48	Red/Black	UD Vented Carbon	fi'zi:k Cycling Insole	Boa IP1-B	Micotex Laser Perforated	350 €



## Aria R3



code	EAN	size	color	outsole	insole	closure	upper material	SRP
R3ARIA18-1010	Various	36-48	Black/Black	UD Carbon	fi'zi:k Cycling Insole	Boa IP1-B	Microtex Laser Perforated	275 €
R3ARIA18-2010	Various	36-48	White/Black	UD Carbon	fi'zi:k Cycling Insole	Boa IP1-B	Microtex Laser Perforated	275 €
R3ARIA18-1030	Various	36-48	Black/Red	UD Carbon	fi'zi:k Cycling Insole	Boa IP1-B	Microtex Laser Perforated	275 €
R3ARIA18-1090	Various	36-48	Black/Yellow Fluo	UD Carbon	fi'zi:k Cycling Insole	Boa IP1-B	Microtex Laser Perforated	275 €

## R4B



code	EAN	size	color	outsole	insole	closure	upper material	SRP
R4MCA-BC-1020	Various	36-48	Black/White	Carbon injected	fi'zi:k Cycling Insole	Boa IP1-A	Microtex Laser Perforated	200 €
R4MCA-BC-1030	Various	40-48	Black/Red	Carbon injected	fi'zi:k Cycling Insole	Boa IP1-A	Microtex Laser Perforated	200 €
R4MCA-BC-2010	Various	40-48	White/Black	Carbon injected	fi'zi:k Cycling Insole	Boa IP1-A	Microtex Laser Perforated	200 €
R4MCA-BC-4210	Various	36-48	Navy/Black	Carbon injected	fi'zi:k Cycling Insole	Boa IP1-A	Microtex Laser Perforated	200 €

R4B  
DONNA

code	EAN	size	color	outsole	insole	closure	upper material	SRP
R4WCA-BC-2052	Various	36-43	White/Emerald Green	Carbon injected	fi'zi:k Cycling Insole	Boa IP1-A	Microtex Laser Perforated	200 €

## Artica R5 Winter Road Shoes With Bootie / Winter Rennrad Schuhe mit Überschuh



code	EAN	size	color	outsole	insole	closure	upper material	SRP
R5ARTIC18-1010	Various	40-48	Black	Carbon Composite Ventilated	fi'zi:k Cycling Insole	Internal Speed Lacing system	Microtex Reinforced Shell	200 €

Tempo R5 Overcurve **NEW**

code	EAN	size	color	outsole	insole	closure	upper material	SRP
TPR5OCMI1-1010	Various	36-48	Black/Black	Carbon Reinforced Nylon	fi'zi:k Cycling Insole	Boa IP1-B	Microtex/Reflective Heel Cap	149 €
TPR5OCMI1-2010	Various	36-48	White/Black	Carbon Reinforced Nylon	fi'zi:k Cycling Insole	Boa IP1-B	Microtex/Reflective Heel Cap	149 €
TPR5OCMI1-1092	Various	36-42	Black/Pink Fluo	Carbon Reinforced Nylon	fi'zi:k Cycling Insole	Boa IP1-B	Microtex/Reflective Heel Cap	149 €
TPR5OCMI1-2030	Various	36-48	White/Red	Carbon Reinforced Nylon	fi'zi:k Cycling Insole	Boa IP1-B	Microtex/Reflective Heel Cap	149 €
TPR5OCMI1-1090	Various	36-48	Black/Yellow F.	Carbon Reinforced Nylon	fi'zi:k Cycling Insole	Boa IP1-B	Microtex/Reflective Heel Cap	149 €

Tempo R5 Powerstrap **NEW**

code	EAN	size	color	outsole	insole	closure	upper material	SRP
TPR5PSPU1-1010	Various	36-48	Black/Black	Carbon Reinforced Nylon	fi'zi:k Cycling Insole	Powerstrap Closure	PU upper Perforated	119 €
TPR5PSPU1-2010	Various	36-48	White/Black	Carbon Reinforced Nylon	fi'zi:k Cycling Insole	Powerstrap Closure	PU upper Perforated	119 €
TPR5PSPU1-9610	Various	36-48	Coral/Black	Carbon Reinforced Nylon	fi'zi:k Cycling Insole	Powerstrap Closure	PU upper Perforated	119 €

## X-ROAD

### Infinito X1



code	EAN	size	color	outsole	insole	closure	upper material	SRP
X1INFIN18-1010	Various	36-48	Black/Black	Uni Direction Full Carbon Outsole	fi'zi:k Cycling Insole	Boa IP1-B	Microtex Laser Perforated	350 €

### Vento X3 Overcurve **NEW**



code	EAN	size	color	outsole	insole	closure	upper material	SRP
VEX3OCMI1-1010	Various	36-48	Black/Black	Carbon Injected with TPU studs	fi'zi:k Cycling Insole	Single dial IP1-Boa	Microtex Laser Perforated with TPU reinforcement	219 €
VEX3OCMI1-2010	Various	36-48	White/Black	Carbon Injected with TPU studs	fi'zi:k Cycling Insole	Single dial IP1-Boa	Microtex Laser Perforated with TPU reinforcement	219 €
VEX3OCMI1-3010	Various	36-48	Red/Black	Carbon Injected with TPU studs	fi'zi:k Cycling Insole	Single dial IP1-Boa	Microtex Laser Perforated with TPU reinforcement	219 €

### Artica X5 Winter MTB Shoes With Bootie / Artica X5 Winter MTB Schuhe mit Überschuh



code	EAN	size	color	outsole	insole	closure	upper material	SRP
X5ARTIC18-1010	Various	40-48	Black	Carbon Composite Ventilated / Rubber Grip	fi'zi:k Cycling Insole	Internal Speed Lacing system	Microtex Reinforced Shell	200 €

## X-ROAD

### Terra X5



code	EAN	size	color	outsole	insole	closure	upper material	SRP
X5TERRA18-1010	Various	36-48	Black/Black	Carbon Reinforced Nylon/ Rubber Grip	fi'zi:k Cycling Insole	Boa L6	Microtex Laser Perforated	159 €
X5TERRA18-1030	Various	36-48	Black/Red	Carbon Reinforced Nylon/ Rubber Grip	fi'zi:k Cycling Insole	Boa L6	Microtex Laser Perforated	159 €
X5TERRA18-7090	Various	36-48	Grey/Yellow Fluo	Carbon Reinforced Nylon/ Rubber Grip	fi'zi:k Cycling Insole	Boa L6	Microtex Laser Perforated	159 €

### Terra X5 Suede



code	EAN	size	color	outsole	insole	closure	upper material	SRP
TEX5VCSU1-5391	Various	36-48	Suede Military Green/ Orange Fluo	Carbon Reinforced Nylon/ Rubber Grip	fi'zi:k Cycling Insole	Boa L6	Suede	175 €
<b>NEW</b> TEX5VCSU1-9756	Various	36-48	Dark Brown Suede/ Sage Green	Carbon Reinforced Nylon/ Rubber Grip	fi'zi:k Cycling Insole	Boa L6	Suede	175 €

### M6B



code	EAN	size	color	outsole	insole	closure	upper material	SRP
M6M-BC-1010	Various	36-48	Black/Black	Carbon Reinforced Nylon/ Rubber Grip	fi'zi:k Cycling Insole	Boa L5	Microtex/Nylon Mesh/ Reflective PU	119 €

## TRANSIRO

### Transiro R1 Infinito Knit **NEW**



code	EAN	size	color	outsole	insole	closure	upper material	SRP
TRR1INKN1-1020	Various	36-48	Black/ White	Uni-Directional Full Carbon Ventilated Outsole	fi'zi:k Cycling Insole	Boa IP1-B	Knitted Upper	380 €

### Transiro R3 Infinito **NEW**



code	EAN	size	color	outsole	insole	closure	upper material	SRP
TRR3INME1-1020	Various	36-48	Black/ White	Full carbon Outsole with Increased Ventilation	fi'zi:k Cycling Insole	Boa IP1 + Powerstrap Closure	Mesh PU Laminated Upper	249 €

### Transiro R4 Powerstrap **NEW**



code	EAN	size	color	outsole	insole	closure	upper material	SRP
TRR4PSMI1-1020	Various	36-48	Black/ White	Injected composite Carbon Outsole	fi'zi:k Cycling Insole	Powerstrap Closure	Mesh upper	119 €
TRR4PSMI1-1030	Various	36-48	Black/ Red	Injected composite Carbon Outsole	fi'zi:k Cycling Insole	Powerstrap Closure	Mesh upper	119 €



## Summer Racing Socks



code	EAN	size	color	description	SRP
FZSCSO 10	8058364011110	XS (36-40)	Black	Temperature control Q-Skin/Lycra Compression and Arch Support	16 €
FZSCSO 10	8058364011127	M (41-44)	Black	Temperature control Q-Skin/Lycra Compression and Arch Support	16 €
FZSCSO 10	8058364011134	XL (45-48)	Black	Temperature control Q-Skin/Lycra Compression and Arch Support	16 €
FZSCSO 20	8058364011363	XS (36-40)	White	Temperature control Q-Skin/Lycra Compression and Arch Support	16 €
FZSCSO 20	8058364011240	M (41-44)	White	Temperature control Q-Skin/Lycra Compression and Arch Support	16 €
FZSCSO 20	8058364011257	XL (45-48)	White	Temperature control Q-Skin/Lycra Compression and Arch Support	16 €
FZSCSO 1030	8058364011790	XS (36-40)	Black/Red	Temperature control Q-Skin/Lycra Compression and Arch Support	16 €
FZSCSO 1030	8058364011806	M (41-44)	Black/Red	Temperature control Q-Skin/Lycra Compression and Arch Support	16 €
FZSCSO 1030	8058364011813	XL (45-48)	Black/Red	Temperature control Q-Skin/Lycra Compression and Arch Support	16 €

## Winter Racing Socks



code	EAN	size	color	description	SRP
FZWCSO 10	8058364011110	XS (36-40)	Black	Temperature control Q-Skin/Lycra Compression and Arch Support	20 €
FZWCSO 10	8058364011127	M (41-44)	Black	Temperature control Q-Skin/Lycra Compression and Arch Support	20 €
FZWCSO 10	8058364011134	XL (45-48)	Black	Temperature control Q-Skin/Lycra Compression and Arch Support	20 €
FZWCSO 20	8058364011363	XS (36-40)	White	Temperature control Q-Skin/Lycra Compression and Arch Support	20 €
FZWCSO 20	8058364011240	M (41-44)	White	Temperature control Q-Skin/Lycra Compression and Arch Support	20 €
FZWCSO 20	8058364011257	XL (45-48)	White	Temperature control Q-Skin/Lycra Compression and Arch Support	20 €
FZWCSO 1030	8058364011851	XS (36-40)	Black/Red	Temperature control Q-Skin/Lycra Compression and Arch Support	20 €
FZWCSO 1030	8058364011882	M (41-44)	Black/Red	Temperature control Q-Skin/Lycra Compression and Arch Support	20 €
FZWCSO 1030	8058364011097	XL (45-48)	Black/Red	Temperature control Q-Skin/Lycra Compression and Arch Support	20 €

## Windproof Toe Cover



code	EAN	size	color	description	SRP
FZTCW 10	8058364011899	XS (36-40)	Black	PU Cloth Main Fabric/Microfiber Toe Cap & Puller/Bottom PU Reinforced	25 €
FZTCW 10	8058364011325	M (41-44)	Black	PU Cloth Main Fabric/Microfiber Toe Cap & Puller/Bottom PU Reinforced	25 €
FZTCW 10	8058364011349	XL /45-48)	Black	PU Cloth Main Fabric/Microfiber Toe Cap & Puller/Bottom PU Reinforced	25 €

## Waterproof Winter Overshoe



code	EAN	size	color	material	SRP
FZSCWP 1094	8058364011271	S (36-39)	Black Reflective	WP and Windproof Upper, Rubberized Bottom for Better Grip, Reflec. logo and Piping	59 €
FZSCWP 1094	8058364011288	M (40-43)	Black Reflective	WP and Windproof Upper, Rubberized Bottom for Better Grip, Reflec. logo and Piping	59 €
FZSCWP 1094	8058364011295	L (44-46)	Black Reflective	WP and Windproof Upper, Rubberized Bottom for Better Grip, Reflec. logo and Piping	59 €
FZSCWP 1094	8058364011301	XL (47-48)	Black Reflective	WP and Windproof Upper, Rubberized Bottom for Better Grip, Reflec. logo and Piping	59 €

## Shoes Spare Parts

CODE	SIZE	COLOR	DESCRIPTION	SRP
FZHSPR1-C 10	S (39-44,5)	Black	Heel Skid Plate (pair) R1B shoes	13 €
FZHSPR1-C 10	L (45-48)	Black	Heel Skid Plate (pair) R1B shoes	13 €
FZHSPR3-C 10	S (36-40,5)	Black	Heel Skid Plate (pair) R3B shoes	13 €
FZHSPR3-C 10	M (41-44,5)	Black	Heel Skid Plate (pair) R3B shoes	13 €
FZHSPR3-C 10	L (45-48)	Black	Heel Skid Plate (pair) R3B shoes	13 €

## Spare Parts/Kit BOA Shoes

CODE	COMPATIBILITY	COLOR	SRP
1000196 - 20	BOA R1 / right+left	White/Transparent	25 €
B1728 - 10	BOA R1 / right+left	Black	25 €
B1601 - 1012	BOA M3 - M5 / only left	Anthracite	16 €
B1602 - 1012	BOA M3 - M5 / only right	Anthracite	16 €
B1729 - 10	BOA M6 / right+left	Black	19 €
B1850 - 10	BOA M4 - TERRA X5 / right+left	Black	19 €

# LINK THE BIB SHORTS INTERFACE FOR EVERY TYPE OF RIDER

## SADDLE AND BIB SHORTS DESIGNED TOGETHER FOR THE VERY FIRST TIME.

LINK is available in three distinct cuts and chamois to match the riders types identified by fi'zik's Spine Concept EVO profiling riders perfectly to match with the three types of riders archetype: Snake, Bull and Chameleon.

## LINK DIE VERBINDENDE BIB SHORT FÜR JEDEN FAHRTYP. SATTEL UND BIB SHORT ZUM ERSTEN MAL MITEINANDER DESIGNT.

LINK ist in drei individuellen Schnitten und Polstern erhältlich, abgestimmt auf den jeweiligen Fahrtyp - welcher anhand fi'zik's Spine Concept Evo ermittelt wird - hierbei wird ein Profil erstellt, welches perfekt auf eines der drei Fahrer Modelle Snake, Bull und Chameleon passt.

APPAREL



**Link R1**  
Made for Snake

sizes available: S/M/L/XL/XXL



code	EAN	color	fit	materials	chamois	leg gripper	weight	SRP
LINKSNR1-10	various	Black/Red	Racing	Lightweight woven fabrics	Lightweight/Breathable 3D moulded seamless	Welded grip stripe/Seamless	155 g	275 €



**Link R1**  
Made for Chameleon

sizes available: S/M/L/XL/XXL



code	EAN	color	fit	materials	chamois	leg gripper	weight	SRP
LINKCHR1-10	Various	Black/Red	Racing	Lightweight woven fabrics	Lightweight/Breathable 3D moulded seamless	Welded grip stripe/Seamless	155 g	275 €



**Link R1**  
Made for Bull

sizes available: S/M/L/XL/XXL



code	EAN	color	fit	materials	chamois	leg gripper	weight	SRP
LINKBLR1-10	Various	Black/Red	Racing	Lightweight woven fabrics	Lightweight/Breathable 3D moulded seamless	Welded grip stripe/Seamless	155 g	275 €

APPAREL



**Link R3**  
Made for Snake

sizes available: S/M/L/XL/XXL



code	EAN	color	fit	materials	chamois	leg gripper	weight	SRP
LINKSNR3-10	Various	Black/Grey	Performance	Specifically developed polyamide and elasthan non-woven fabrics	lightweight/breathable high performance chamois	silicon printed elastic	189 g	180 €



**Link R3**  
Made for Chameleon

sizes available: S/M/L/XL/XXL



code	EAN	color	fit	materials	chamois	leg gripper	weight	SRP
LINKCHR3-10	Various	Black/Grey	Performance	Specifically developed polyamide and elasthan non-woven fabrics	lightweight/breathable high performance chamois	silicon printed elastic	189 g	180 €



**Link R3**  
Made for Bull

sizes available: S/M/L/XL/XXL



code	EAN	color	fit	materials	chamois	leg gripper	weight	SRP
LINKBLR3-10	Various	Black/Grey	Performance	Specifically developed polyamide and elasthan non-woven fabrics	lightweight/breathable high performance chamois	silicon printed elastic	189 g	180 €





# COMPONENTS

COMPONENTS



**Cyrano handlebar 00**  
Made for Snake

Body Material: Highmodulus Uni-Directional Carbon  
Finishing: Matt Black/Yellow 00 details



code	EAN	diameter	size (mm)	reach	drop	weight	SRP
114012R	8021890387394	31,8 (clamp) -24,8 (top)	400 center to center	80 mm	130 mm		350 €
114013R	8021890387400	31,8 (clamp) -28,8 (top)	420 center to center	85 mm	140 mm	175 g	350 €
114014R	8021890387417	31,8 (clamp) -28,8 (top)	440 center to center	85 mm	140 mm		350 €
114015R	8021890387424	31,8 (clamp) -28,8 (top)	460 center to center	85 mm	140 mm		350 €



**Cyrano handlebar 00**  
Made for Chameleon

Body Material: Highmodulus Uni-Directional Carbon  
Finishing: Matt Black/Yellow 00 details



code	EAN	diameter	size (mm)	reach	drop	weight	SRP
114007R	8021890387349	31,8 (clamp) -24,8 (top)	400 center to center	80 mm	130 mm		350 €
114008R	8021890387356	31,8 (clamp) -28,8 (top)	420 center to center	85 mm	135 mm	175 g	350 €
114009R	8021890387363	31,8 (clamp) -28,8 (top)	440 center to center	85 mm	135 mm		350 €
114010R	8021890387370	31,8 (clamp) -28,8 (top)	460 center to center	85 mm	135 mm		350 €



**Cyrano handlebar 00**  
Made for Bull

Body Material: Highmodulus Uni-Directional Carbon  
Finishing: Matt Black/Yellow 00 details



code	EAN	diameter	size (mm)	reach	drop	weight	SRP
114002R	8021890387295	31,8 (clamp) -24,8 (top)	400 center to center	75 mm	125 mm		350 €
114003R	8021890387301	31,8 (clamp) -28,8 (top)	420 center to center	80 mm	130 mm	175 g	350 €
114004R	8021890387318	31,8 (clamp) -28,8 (top)	440 center to center	80 mm	130 mm		350 €
114005R	8021890387325	31,8 (clamp) -28,8 (top)	460 center to center	80 mm	130 mm		350 €

COMPONENTS



**Cyrano handlebar R1**  
Made for Snake

Body Material: Uni-Directional Carbon  
Finishing: Glossy Carbon/Red R1 details



code	EAN	diameter	size (mm)	reach	drop	weight	SRP
114027R	8021890387547	31,8 (clamp) -24,8 (top)	400 center to center	80 mm	130 mm		250 €
114028R	8021890387554	31,8 (clamp) -28,8 (top)	420 center to center	85 mm	140 mm	205 g	250 €
114029R	8021890387561	31,8 (clamp) -28,8 (top)	440 center to center	85 mm	140 mm		250 €
114030R	8021890387578	31,8 (clamp) -28,8 (top)	460 center to center	85 mm	140 mm		250 €



**Cyrano handlebar R1**  
Made for Chameleon

Body Material: Uni-Directional Carbon  
Finishing: Glossy Carbon/Red R1 details



code	EAN	diameter	size (mm)	reach	drop	weight	SRP
114022R	8021890387493	31,8 (clamp) -24,8 (top)	400 center to center	80 mm	130 mm		250 €
114023R	8021890387509	31,8 (clamp) -28,8 (top)	420 center to center	85 mm	135 mm	205 g	250 €
114024R	8021890387516	31,8 (clamp) -28,8 (top)	440 center to center	85 mm	135 mm		250 €
114025R	8021890387523	31,8 (clamp) -28,8 (top)	460 center to center	85 mm	135 mm		250 €



**Cyrano handlebar R1**  
Made for Bull

Body Material: Uni-Directional Carbon  
Finishing: Glossy Carbon/Red R1 details



code	EAN	diameter	size (mm)	reach	drop	weight	SRP
114017R	8021890387448	31,8 (clamp) -24,8 (top)	400 center to center	75 mm	125 mm		250 €
114018R	8021890387455	31,8 (clamp) -28,8 (top)	420 center to center	80 mm	130 mm	205 g	250 €
114019R	8021890387462	31,8 (clamp) -28,8 (top)	440 center to center	80 mm	130 mm		250 €
114020R	8021890387479	31,8 (clamp) -28,8 (top)	460 center to center	80 mm	130 mm		250 €

COMPONENTS



**Cyrano handlebar R3**  
Made for Snake

Body Material: Aluminum Ergal  
Finishing: Matt Sandblasted Black/White R3 details



code	EAN	diameter	size (mm)	reach	drop	weight	SRP
114041R	8021890387684	31,8 (clamp) -24,8 (top)	380 center to center	75 mm	125 mm		99 €
114042R	8021890387691	31,8 (clamp) -24,8 (top)	400 center to center	80 mm	130 mm	245 g	99 €
114043R	8021890387707	31,8 (clamp) -28,8 (top)	420 center to center	85 mm	140 mm		99 €
114044R	8021890387714	31,8 (clamp) -28,8 (top)	440 center to center	85 mm	140 mm		99 €
114045R	8021890387721	31,8 (clamp) -28,8 (top)	460 center to center	85 mm	140 mm		99 €



**Cyrano handlebar R3**  
Made for Chameleon

Body Material: Aluminum Ergal  
Finishing: Matt Sandblasted Black/White R3 details



code	EAN	diameter	size (mm)	reach	drop	weight	SRP
114036R	8021890367639	31,8 (clamp) -24,8 (top)	380 center to center	80 mm	130 mm		99 €
114037R	8021890387646	31,8 (clamp) -24,8 (top)	400 center to center	80 mm	130 mm	245 g	99 €
114038R	8021890387653	31,8 (clamp) -28,8 (top)	420 center to center	85 mm	135 mm		99 €
114039R	8021890387660	31,8 (clamp) -28,8 (top)	440 center to center	85 mm	135 mm		99 €
114040R	8021890387677	31,8 (clamp) -28,8 (top)	460 center to center	85 mm	135 mm		99 €



**Cyrano handlebar R3**  
Made for Bull

Body Material: Aluminum Ergal  
Finishing: Matt Sandblasted Black/White R3 details



code	EAN	diameter	size (mm)	reach	drop	weight	SRP
114031R	8021890387585	31,8 (clamp) -24,8 (top)	380 center to center	75 mm	125 mm		99 €
114032R	8021890387592	31,8 (clamp) -24,8 (top)	400 center to center	75 mm	125 mm	245 g	99 €
114033R	8021890387608	31,8 (clamp) -28,8 (top)	420 center to center	80 mm	130 mm		99 €
114034R	8021890387615	31,8 (clamp) -28,8 (top)	440 center to center	80 mm	130 mm		99 €
114035R	8021890387622	31,8 (clamp) -28,8 (top)	460 center to center	80 mm	130 mm		99 €

COMPONENTS



**Cyrano handlebar R5**  
Made for Snake

Body Material: Aluminum Anticordal  
Finishing: Matt Sandblasted Black R5 details



code	EAN	diameter	size (mm)	reach	drop	weight	SRP
114057R	8021890439185	31,8 (clamp) -24,8 (top)	400 center to center	80 mm	130 mm		49 €
114058R	8021890439192	31,8 (clamp) -28,8 (top)	420 center to center	85 mm	140 mm	310 g	49 €
114059R	8021890439208	31,8 (clamp) -28,8 (top)	440 center to center	85 mm	140 mm		49 €



**Cyrano handlebar R5**  
Made for Chameleon

Body Material: Aluminum Anticordal  
Finishing: Matt Sandblasted Black R5 details



code	EAN	diameter	size (mm)	reach	drop	weight	SRP
114052R	8021890439154	31,8 (clamp) -24,8 (top)	400 center to center	80 mm	130 mm		49 €
114053R	8021890439161	31,8 (clamp) -28,8 (top)	420 center to center	85 mm	135 mm	310 g	49 €
114054R	8021890439178	31,8 (clamp) -28,8 (top)	440 center to center	85 mm	135 mm		49 €



**Cyrano handlebar R5**  
Made for Bull

Body Material: Aluminum Anticordal  
Finishing: Matt Sandblasted Black R5 details



code	EAN	diameter	size (mm)	reach	drop	weight	SRP
114047R	8021890439123	31,8 (clamp) -24,8 (top)	400 center to center	75 mm	125 mm		49 €
114048R	8021890439130	31,8 (clamp) -28,8 (top)	420 center to center	80 mm	130 mm	310 g	49 €
114049R	8021890439147	31,8 (clamp) -28,8 (top)	440 center to center	80 mm	130 mm		49 €



**Cyrano 00 Seatpost**

Body Material: Highmodulus Uni-Directional Carbon  
 Head Material: Aluminum-Ergal  
 Bolts: Titanium  
 Finishing: Matt Black/Yellow 00 details

code	EAN	diameter	size	seatback	weight	SRP
114177R	8021890411570	Cyrano Carbon Seatpost 27,2	330 mm	25 mm	175 g	250 €
114178R	8021890411594	Cyrano Carbon Seatpost 31,6	330 mm	25 mm	195 g	250 €

**Cyrano R3 Seatpost**

Body Material: Aluminum-Ergal  
 Head Material: Aluminum-Ergal  
 Bolts: Stainless steel  
 Finishing: Matt Sandblasted Black/Red R3 details

code	EAN	diameter	size	seatback	weight	SRP
114119R	8021890388995	27,2	330 mm	25 mm		99 €
114120R	8021890389008	27,2	400 mm	26 mm	215 g	99 €
114125R	8021890389039	31,6	330 mm	27 mm		99 €
114126R	8021890389046	31,6	400 mm	28 mm		99 €

**Cyrano R5 Seatpost**

Body Material: Aluminum-Ergal  
 Head Material: Aluminum-Ergal  
 Bolts: Stainless steel

code	EAN	diameter	size	seatback	weight	SRP
114131R	8021890439284	27,2	330 mm	25 mm		49 €
114132R	8021890439291	27,2	400 mm	26 mm	215 g	49 €
114137R	8021890439307	31,6	330 mm	27 mm		49 €
114138R	8021890439314	31,6	400 mm	28 mm		49 €



**Cyrano R1 stem**

Body Material: Aluminum-Ergal  
 Head Material: Aluminum-Anticorodal  
 Bolts: Titanium  
 Finishing: Matt Sandblasted Black/Red R1 details

code	EAN	diameter	size	angle	weight	SRP
114062R	8021890 387745	31,8 mm	70 mm	7 °		99 €
114063R	8021890387752	31,8 mm	80 mm	7 °	128 g	99 €
114064R	8021890387769	31,8 mm	90 mm	7 °		99 €
114065R	8021890387776	31,8 mm	100 mm	7 °		99 €
114066R	8021890387783	31,8 mm	110 mm	7 °		99 €
114067R	8021890387790	31,8 mm	120 mm	7 °		99 €
114068R	8021890387806	31,8 mm	130 mm	7 °		99 €
114072R	8021890387844	31,8 mm	80 mm	20 °		99 €
114073R	8021890387851	31,8 mm	90 mm	20 °		99 €
114074R	8021890387868	31,8 mm	100 mm	20 °		99 €
114075R	8021890387875	31,8 mm	110 mm	20 °		99 €
114076R	8021890387882	31,8 mm	120 mm	20 °		99 €
114077R	8021890387899	31,8 mm	130 mm	20 °		99 €

**Cyrano R5 stem**

Body Material: Aluminum-Anticorodal  
 Head Material: Aluminum-Anticorodal  
 Bolts: Stainless Steel

code	EAN	diameter	size	angle	weight	SRP
114099R	8021890439222	31,8 mm	80 mm	7 °		49 €
114100R	8021890439239	31,8 mm	90 mm	7 °	152 g	49 €
114101R	8021890439246	31,8 mm	100 mm	7 °		49 €
114102R	8021890439253	31,8 mm	110 mm	7 °		49 €
114103R	8021890439260	31,8 mm	120 mm	7 °		49 €
114104R	8021890439277	31,8 mm	130 mm	7 °		49 €



**Stem Bolt replacing kit**



**Seatpost 00 Bolt replacing kit**



**Seatpost R1/R3 Bolt replacing kit**



code	EAN	description	bolts	vis	SRP
114184R	8021890 423894	Stem bolt replacing kit	Titanium	Titanium	35 €
114192R	8021890 432049	Seatpost 00 bolt replacing kit	Titanium	Titanium	30 €
114191R	8021890 432032	Seatpost R1/R3 bolt replacing kit	Stainless steel	Acier inoxydable	20 €



# ACCESSORIES

### Vento Microtex Tacky



code	EAN	color	construction	touch	thickness	SRP
BT09 A00042	8021890466457	Black	Microtex	Tacky	2,0 mm	34,90 €
BT09 A00044	8021890466464	White	Microtex	Tacky	2,0 mm	34,90 €
BT09 A00012	8021890466440	Red	Microtex	Tacky	2,0 mm	34,90 €
BT09 A00047	8021890466488	Orange Fluo	Microtex	Tacky	2,0 mm	34,90 €
BT09 A00050	8021890466495	Pink Fluo	Microtex	Tacky	2,0 mm	34,90 €
BT09 A00046	8021890466471	Yellow Fluo	Microtex	Tacky	2,0 mm	34,90 €
BT09 A00051	8021890466501	Lilla Fluo	Microtex	Tacky	2,0 mm	34,90 €
BT09 A00009	8021890466433	Celeste	Microtex	Tacky	2,0 mm	34,90 €

### Vento Solocush Tacky



code	EAN	color	construction	touch	thickness	SRP
BT11 A00042	8021890466686	Black	Solocush	Tacky	2,7 mm	37,90 €
BT11 A00044	8021890466693	White	Solocush	Tacky	2,7 mm	37,90 €
BT11 A00055	8021890467034	Blue	Solocush	Tacky	2,7 mm	37,90 €
BT11 A00025	8021890466679	Green	Solocush	Tacky	2,7 mm	37,90 €
BT11 A00012	8021890466655	Red	Solocush	Tacky	2,7 mm	37,90 €
BT11 A00011	8021890466648	Pink	Solocush	Tacky	2,7 mm	37,90 €
BT11 A00014	8021890466662	Yellow	Solocush	Tacky	2,7 mm	37,90 €
BT11 A00047	8021890466716	Orange Fluo	Solocush	Tacky	2,7 mm	37,90 €
BT11 A00050	8021890466723	Pink Fluo	Solocush	Tacky	2,7 mm	37,90 €
BT11 A00046	8021890466709	Yellow Fluo	Solocush	Tacky	2,7 mm	37,90 €
BT11 A00051	8021890466730	Lilla Fluo	Solocush	Tacky	2,7 mm	37,90 €
BT11 A00009	8021890466631	Celeste	Solocush	Tacky	2,7 mm	37,90 €

### Terra Microtex Bondcush Tacky



code	EAN	color	construction	touch	thickness	SRP
BT12 A00002	8021890466747	Black	Microtex Bondcush	Tacky	3,0 mm	37,90 €
BT12 A00016	8021890466761	White	Microtex Bondcush	Tacky	3,0 mm	37,90 €
BT12 A00012	8021890466754	Red	Microtex Bondcush	Tacky	3,0 mm	37,90 €
BT12 A00052	8021890466778	Dark Blue	Microtex Bondcush	Tacky	3,0 mm	37,90 €
BT12 A00053	8021890466785	Green/Blue	Microtex Bondcush	Tacky	3,0 mm	37,90 €
BT12 A00054	8021890466792	Brown	Microtex Bondcush	Tacky	3,0 mm	37,90 €

### Tempo Microtex Classic



code	EAN	color	construction	touch	thickness	SRP
BT10 A00032	8021890466600	Black	Microtex	Classic	2,0 mm	19,90 €
BT10 A00010	8021890466549	White	Microtex	Classic	2,0 mm	19,90 €
BT10 A00055	8021890467027	Blue	Microtex	Classic	2,0 mm	19,90 €
BT10 A00025	8021890466594	Green	Microtex	Classic	2,0 mm	19,90 €
BT10 A00012	8021890466563	Red	Microtex	Classic	2,0 mm	19,90 €
BT10 A00011	8021890466556	Pink	Microtex	Classic	2,0 mm	19,90 €
BT10 A00014	8021890466570	Yellow	Microtex	Classic	2,0 mm	19,90 €
BT10 A00045	8021890466617	Orange	Microtex	Classic	2,0 mm	19,90 €
BT10 A00018	8021890466587	Honey	Microtex	Classic	2,0 mm	19,90 €
BT10 A00006	8021890466525	Silver	Microtex	Classic	2,0 mm	19,90 €
BT10 A00009	8021890466532	Celeste	Microtex	Classic	2,0 mm	19,90 €

### Tempo Microtex Bondcush Classic



code	EAN	color	construction	touch	thickness	SRP
BT13 A00032	8021890466891	Black	Microtex Bondcush	Classic	3,0 mm	24,90 €
BT13 A00010	8021890466839	White	Microtex Bondcush	Classic	3,0 mm	24,90 €
BT13 A00055	8021890467041	Blue	Microtex Bondcush	Classic	3,0 mm	24,90 €
BT13 A00025	8021890466884	Green	Microtex Bondcush	Classic	3,0 mm	24,90 €
BT13 A00012	8021890466853	Red	Microtex Bondcush	Classic	3,0 mm	24,90 €
BT13 A00011	8021890466846	Pink	Microtex Bondcush	Classic	3,0 mm	24,90 €
BT13 A00014	8021890466860	Yellow	Microtex Bondcush	Classic	3,0 mm	24,90 €
BT13 A00045	8021890466907	Orange	Microtex Bondcush	Classic	3,0 mm	24,90 €
BT13 A00018	8021890466877	Honey	Microtex Bondcush	Classic	3,0 mm	24,90 €
BT13 A00006	8021890466815	Silver	Microtex Bondcush	Classic	3,0 mm	24,90 €
BT13 A00009	8021890466822	Celeste	Microtex Bondcush	Classic	3,0 mm	24,90 €

### Tempo Microtex Bondcush Soft



code	EAN	color	construction	touch	thickness	SRP
BT14 A00002	8021890466914	Black	Microtex Bondcush	Soft	3,0 mm	24,90 €
BT14 A00025	8021890467003	Green	Microtex Bondcush	Soft	3,0 mm	24,90 €
BT14 A00012	8021890466969	Red	Microtex Bondcush	Soft	3,0 mm	24,90 €
BT14 A00014	8021890466976	Yellow	Microtex Bondcush	Soft	3,0 mm	24,90 €
BT14 A00045	8021890467010	Orange	Microtex Bondcush	Soft	3,0 mm	24,90 €

## ACCESSORIES

### Kli:k Bag



code	EAN	size	color	description	SRP
FB05S00A0X004	8021890427298	S	Anthracite	Cordura Shell / WP Zip, Internal Pocket / Reflective Piping	19,90 €
FB05M00A0X004	8021890427403	M	Anthracite	Reflective logo / ICS clip	24,90 €

### Lin:k Bag



code	EAN	size	color	description	SRP
FB06S00A0X004	8021890427311	S	Anthracite	Cordura Shell / WP Zip Internal Pocket / Reflective Piping	17,90 €
FB06M00A0X004	8021890427304	M	Anthracite	Reflective logo / Velcro straps	22,90 €

### 00 Saddle Bag



code	EAN	size	color	description	SRP
FB0700 A031111	8021890428486	One Size	Black	Thermo-Formed Classic and Gummy Microtex / TPR Closure System Padded Inside / 00 Details	40 €

### Lumo L1 / Lumo L5



code	EAN	color	description	SRP
BLF3 A00000	8021890427199	Black	LUMO L1: 4 red modes / white courtesy light USB rechargeable / ICS and seatpost compatible	35 €
BLF4 A00000	8021890427205	Black	LUMO L5: 4 red modes / USB rechargeable ICS and seatpost compatible	24,90 €



SeatPost Rings



code	EAN	color	material	SRP
FZKR A30003	8021890363978	White, Black, Yellow, Red, Green, Seed Blue, Dark Blue	Kit of 42 Silicon Rings, mixed colours and sizes	6 € cad.
FZKR A7S007	8021890393036	White	Silicon Ring 27,2 mm	6 €
FZKR A8S009	8021890393043	Black	Silicon Ring 27,2 mm	6 €
FZKR A9S003	8021890393050	Red	Silicon Ring 27,2 mm	6 €
FZKR B0S007	8021890393067	White	Silicon Ring 30,9 - 31 mm	6 €
FZKR B1S009	8021890393074	Black	Silicon Ring 30,9 - 31 mm	6 €
FZKR B2S003	8021890393081	Red	Silicon Ring 30,9 - 31 mm	6 €

Kit Bar:Gel + Tape



Bar:Gel



Performance Road Bar:Gel

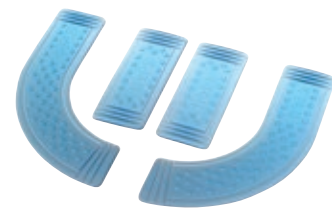

code	EAN	description	SRP
BG01 A00002	8021890225108	Black Microtex Bar Tape + Bar Gel	33,90 €
BG02 A00003	8021890235756	4 Pieces of Gel (2 curved + 2 straight)	20 €
BG06 A00000	8021890367518	4 Pieces of Medical TechnoGel (2 curved + 2 straight)	24,90 €

Tri Gel:Pad



code	EAN	description	SRP
BG04 A03900	8021890264565	Technogel Pad Designed for Profile F19/F22 Armrest	35 €
BG05 A03900	8021890264589	Technogel Pad Designed for Vision Armrest	35 €

Aliante Scuff Guards Kit



code	EAN	description	SRP
FZKS H00000	8021890425607	3 sets of scuff guards and 12 spare bolts / White, Black, Red	19,90 €
FZKS H10000	8021890425614	3 sets of scuff guards and 12 spare bolts / Green, Anthracite, Blue	19,90 €

Transiro Mistica Carriage Kit



code	EAN	description	SRP
FZKS J20000	8021890431769	Integral aluminum carriage kit, with 4 bolts	30 €



**Spine Concept Versus Evo Saddle Display**



<b>code</b>	FZKS L00000
<b>EAN</b>	8021890457233
<b>dimension</b>	180x50x50 cm
<b>description</b>	New Spine Concept Versus Evo Display + 12 Versus Evo Saddles

**Spine Concept Evo Open 2018 Saddle Display**



<b>code</b>	FZKS L10000
<b>EAN</b>	8021890457240
<b>dimension</b>	170x70x15 cm
<b>description</b>	New Spine Concept Open Display + 12 Open Saddles

**Spine Concept Evo Full Update Kit**

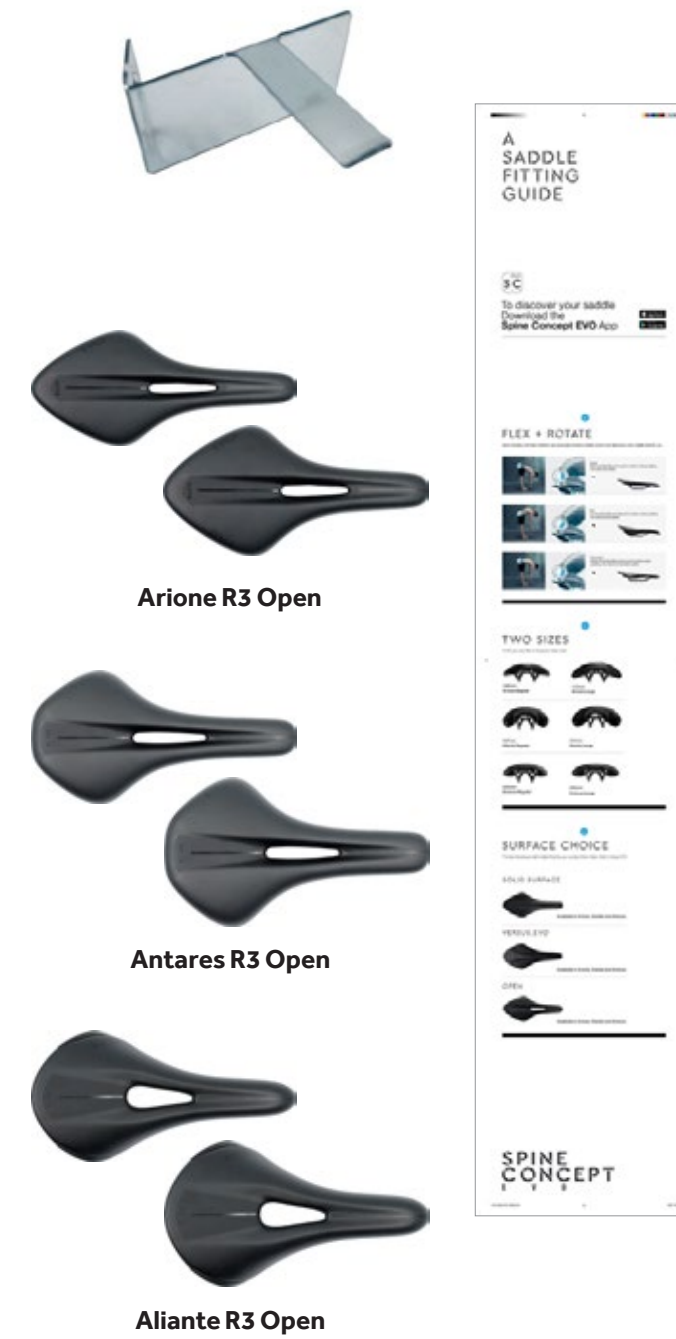







<b>code</b>	FZKS L50000
<b>EAN</b>	8021890460196
<b>dimension</b>	-
<b>description</b>	New Board + New Hooks + 6 R3 Open Saddles (3 Regular + 3 Large)

**Shoes Shelf NEW**



<b>code</b>	FZME 10
<b>EAN</b>	8058364043326
<b>dimension</b>	w 280 / h 65 / d 110 mm
<b>description</b>	Shelf Shoes Black
<b>SRP</b>	6 €

**New Open Test Kit**

Regular			
	ARIONE	ANTARES	ALIANTE
Large			
<b>code</b>	<b>EAN</b>	<b>description</b>	
FZKS L30000	8021890459701	6 R3 Open Test Saddles (3 Regular + 3 Large)	

**New Versus Evo Test Kit**

Regular			
	ARIONE	ANTARES	ALIANTE
Large			
<b>code</b>	<b>EAN</b>	<b>description</b>	
FZKS L40000	8021890459718	6 R3 Versus Evo Test Saddles (3 Regular + 3 Large)	

**Solid Surface Test Kit**

ARIONE		ANTARES		ALIANTE	
					
Regular	Large	Regular	Large	Regular	Large
<b>code</b>	<b>EAN</b>	<b>description</b>			
FZKS K20000	8021890448187	3 R3 Solid Test Saddles Regular (Arione, Antares, Aliante)			
FZKS K30000	8021890448194	3 R3 Solid Test Saddles Large (Arione, Antares, Aliante)			

**Transiro Mistica Test Kit**

			
Regular	Large	Regular	Large
<b>code</b>	<b>EAN</b>	<b>description</b>	
FZKS K50000	8021890448682	TRANSIRO MISTICA TEST KIT: 1 Mistica k:i:um Regular Test+ 1 Mistica k:i:um Large Test	
FZKS K70000	8021890448705	LUCE TEST KIT: 1 Luce R5 Regular Test + 1 Luce R5 Large Test	

**Luce Test Kit**

**Bar tape Selector  
+ 48 Bar tapes**



<b>code</b>	FZKW B10000
<b>EAN</b>	8021890468697
<b>dimension</b>	w 260 / h 400 / d 300 mm
<b>description</b>	2 Wheels Bar tape Display + 48 fi'zi:k Bar tapes

**Vento Microtex Tacky / 2,0 mm**



**Vento Solocush Tacky / 2,7 mm**



**Terra Microtex Bondcush Tacky / 3,0 mm**



**Tempo Microtex Classic / 2,0 mm**



**Tempo Microtex Bondcush Classic / 3,0 mm**



**Tempo Microtex Bondcush Soft / 3,0 mm**







## PRODUCTS OF OUR ENVIRONMENT | PRODUKTE UNSERER UMGEBUNG

---

We seek adventure and the freedom it provides.  
We find solitude deep within the mountain range and revel in the camaraderie of a post ride brew.  
We are forged in the challenge of competition and savor the sweet taste of victory.

Wir streben nach Abenteuer und der damit verbundenen Freiheit. Wir finden die Einsamkeit in den Weiten der Berge  
und feiern diese gemeinschaftlich bei einer Tasse frisch aufgebrühten Kaffee.  
Wir sind getrieben von der Herausforderung des Wettkampfs und genießen den süßen Geschmack des Sieges.

---

**WE ENGINEER MOUNTAIN BIKE COMPONENTS THAT DELIVER SUPERIOR FUNCTION THROUGH DISRUPTIVE DESIGN.  
WIR ENTWICKELN MOUNTAINBIKE KOMPONENTEN WELCHE ÜBERRAGENDE FUNKTION IM EIGENTSTÄNDIGEN DESIGN BIETEN.**

 crankbrothers

# A REVOLUTION IN TERMS OF PERFORMANCE AND RELIABILITY

New models, advanced technologies and high-end components  
are combined in our pedals line.

EINE REVOLUTION IN SACHEN PERFORMANCE UND ZUVERLÄSSIGKEIT

Neue Modelle, verbesserte Technologie und High-End Komponenten,  
zusammengefasst in unserer Pedal Palette



## PREMIUM INTERNAL COMPONENTS | PREMIUM BAUTEILE

LONGEVITY, DURABILITY AND PERFORMANCE | LANGLEBIGKEIT, HALTBARKEIT UND PERFORMANCE

### ENDURO CARTRIDGE BEARING | ENDURO WÄRLZLAGER

#### DOUBLE LIP INTERNAL SEAL EXTERNAL SEAL

- prevents water and debris from entering the pedal
- lab tested and ride proven in extreme conditions
- prevents contamination and extends life of pedal

#### DOUBLE LIP, INNERE UND ÄUSSERE DICHTUNG

- verhindert dass Wasser und Staub ins Pedalinnere eindringen
- im Labor und unter reellen Bedingungen in extremen Situationen getestet
- verhindert Verschmutzung und verlängert die Funktionsfähigkeit des Pedals



### IGUS LL-GLIDE BEARING | IGUS LL-GLEITLAGER

#### PREMIUM INBOARD BEARING

- exclusive formulation for Crankbrothers
- 8x better performance in igus lab testing
- up to 74x better performance in our most aggressive in-house lab testing
- performs in the most adverse condition

#### PREMIUM INBOARD LAGER

- exklusiv für Crankbrothers hergestellt
- 8x bessere Performance im Igus Labor Test
- bis zu 74x bessere Performance in unseren härtesten In-House Labor Tests
- funktioniert auch unter widrigsten Bedingungen



### DOUBLE SEAL SYSTEM | DOPPEL DICHTUNGS SYSTEM

#### DOUBLE LIP INTERNAL SEAL EXTERNAL SEAL

- prevents water and debris from entering the pedal
- lab tested and ride proven in extreme conditions
- prevents contamination and extends life of pedal

#### DOUBLE LIP, INNERE UND ÄUSSERE DICHTUNG

- verhindert dass Wasser und Staub ins Pedalinnere eindringen
- im Labor und unter reellen Bedingungen in extremen Situationen getestet
- verhindert Verschmutzung und verlängert die Funktionsfähigkeit des Pedals



internal seal double-lip  
interne Dichtung mit Doppellippe

external seal  
externe Dichtung

## 3D APPROACH: LENGTH AND WIDTH | 3D ANSATZ: LÄNGE & BREITE

OPTIMAL SURFACE AREA | OPTIMALE AUFSTANDSFLÄCHE

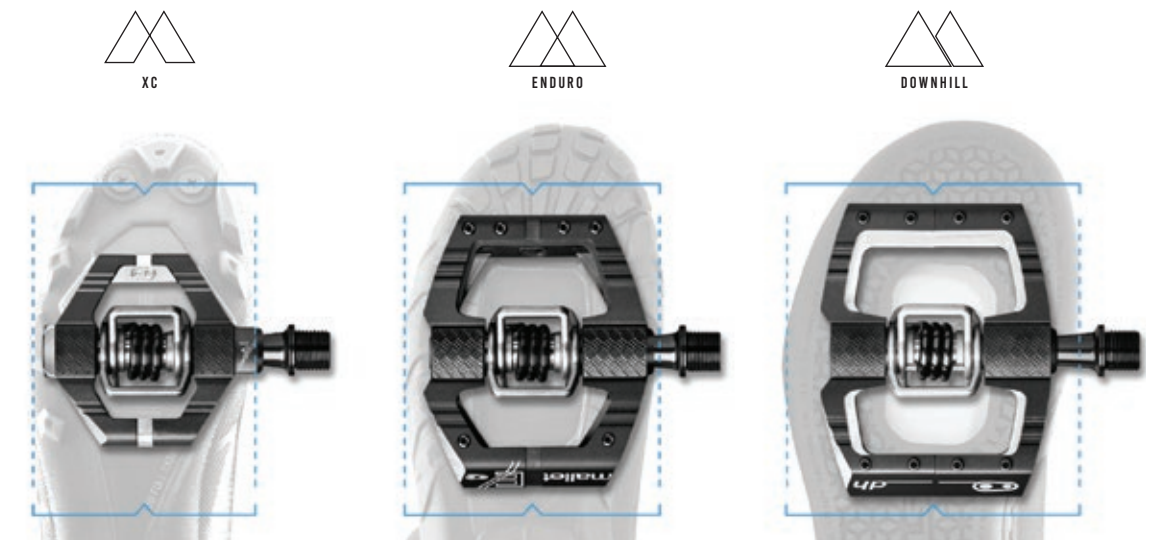

CANDY 7

90-105 mm SHOE WIDTH

MALLET E

105-110 mm SHOE WIDTH

MALLET DH

100+mm SHOE WIDTH

- Based on research of shoe outsole surface areas
- Optimized pedal surface area for all riding disciplines
- Maximizes grip, support, and interface with pedal
- Long spindle on relevant models

- Basierend auf Recherche verschiedener Schuhsohlenoberflächen
- Optimierte Pedal Aufstandsfläche für die jeweilige Disziplin
- Maximierter Grip, Support und bessere Verbindung mit dem Pedal
- Breitere Achse je nach Modell

## 3D APPROACH: TREAD DEPTH | 3D ANSATZ: PROFIL TIEFE

OPTIMIZING INTERFACE BETWEEN PEDAL AND SHOE | OPTIMIERTE VERBINDUNG ZWISCHEN PEDAL UND SCHUH

### TRACTION PAD TECHNOLOGY | TRACTION PAD TECHNOLOGIE

- Interchangeable polyurethane pads allows tuning of the pedal/shoe interface
- Optimizes cleat engagement
- Optimizes shoe tread contact with pedal body
- Customizable to get the perfect interface for any shoe

- Anpassen der Verbindung zwischen Pedal und Schuh dank austauschbarer Polyurethan Pads
- Optimiertes Einklinken der Cleats
- Verbessertes Halt zwischen Schuhprofil und dem Pedalkörper
- Anpassbar um die perfekte Verbindung für jeden Schuh zu finden

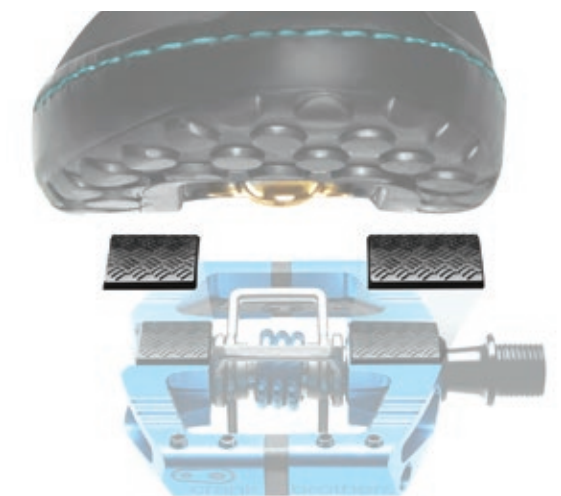

# THE MALLET COLLECTION



## MALLET DH 11



black/gold

code	16096
weight	445 g
price	€ 350

## MALLET DH RACE



red

black

red/blue/black

code	16095	16094	16248
weight	479 g	479 g	479 g
price	€ 169	€ 169	€ 169

// LIMITED EDITION

SUPER BRUNI MALLET DH 11  
// LIMITED EDITION



# THE MALLET COLLECTION



## MALLET E 11

## MALLET E



	black/gold	black	blue
code	16093	15990	15991
weight	385 g	419 g	419 g
price	€ 350	€ 169	€ 169

## MALLET E LS (LONG SPINDLE)



	blue/black	silver/black
code	16080	16247
weight	424 g	424 g
price	€ 169	€ 169

# THE MALLET COLLECTION



## MALLET E LS // LIMITED EDITION



	silver/black	red/red	green/black
code	16204	16202	16203
weight	424 g	424 g	424 g
price	€ 169	€ 169	€ 169

## MALLET 3

## MALLET 2



	black/raw/blue	red/raw/red	silver/raw/black	green/raw/black
code	15988	15989	15986	15987
weight	499 g	499 g	508 g	508 g
price	€ 139	€ 139	€ 100	€ 100



# THE CANDY COLLECTION

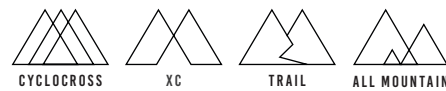

## CANDY 11

## CANDY 7

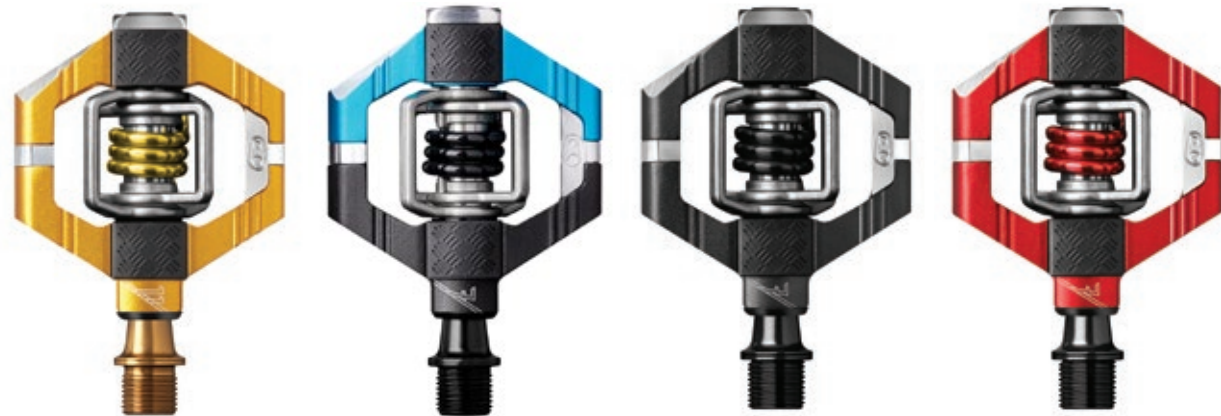

	gold	electric blue/black	black	red
code	15984	16178	15981	15982
weight	230 g	320 g	320 g	320 g
price	€ 450	€ 169	€ 169	€ 169

## CANDY 3



	black	slate blue	dark red
code	16175	16176	16177
weight	340 g	340 g	340 g
price	€ 139	€ 139	€ 139



# THE CANDY COLLECTION

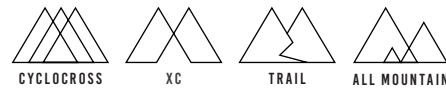

## CANDY 2



	dark grey	green
code	16173	16174
weight	355 g	355 g
price	€ 100	€ 100

## CANDY 1



	black	red	blue	pink
code	16169	16170	16171	16172
weight	294 g	294 g	294 g	294 g
price	€ 60	€ 60	€ 60	€ 60

# THE EGGBEATER COLLECTION

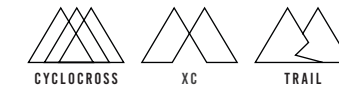

## EGGBEATER 11

## EGGBEATER 3

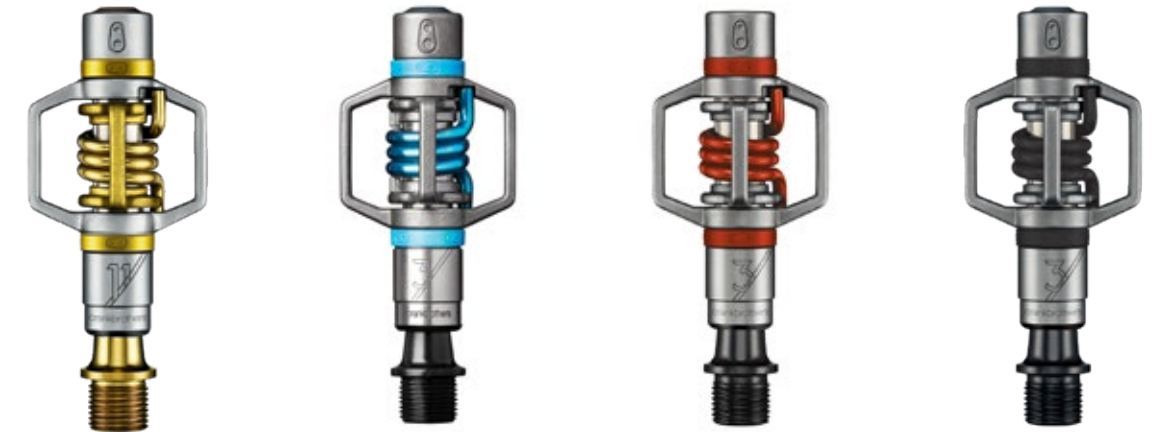

	gold	light blue/electric blue	red	black
code	11495	16098	15319	15859
weight	179 g	280 g	280 g	280 g
price	€ 450	€ 139	€ 139	€ 139

## EGGBEATER 2

## EGGBEATER 1



	black	black/green	silver/black	silver/red
code	15317	15985	14791	14792
weight	285 g	285 g	290 g	290 g
price	€ 100	€ 100	€ 60	€ 60

## FIND YOUR PERFECT SIZE | FINDE DEINE IDEALE GRÖSSE

WE ANALYZED OUTSOLE PROFILES FROM THE TOP MOUNTAIN BIKE SHOE BRANDS AND DISCOVERED TWO DISTINCT SURFACE AREAS TO OPTIMIZE THE SHOE/PEDAL INTERFACE FOR THE ENTIRE RANGE OF SHOE SIZES

WIR HABEN DIE SOHLENPROFILE DER TOP MOUNTAINBIKESCHUH HERSTELLER ANALYSIERT UND SIND DADURCH AUF ZWEI WESENTLICHE PEDALKÖRPERGRÖSSEN GESTOSSEN MIT DENEN WIR EINEN BESSEREN HALT ZWISCHEN SCHUH UND PEDAL FÜR ALLE SCHUHGRÖSSEN ERMÖGLICHEN KÖNNEN

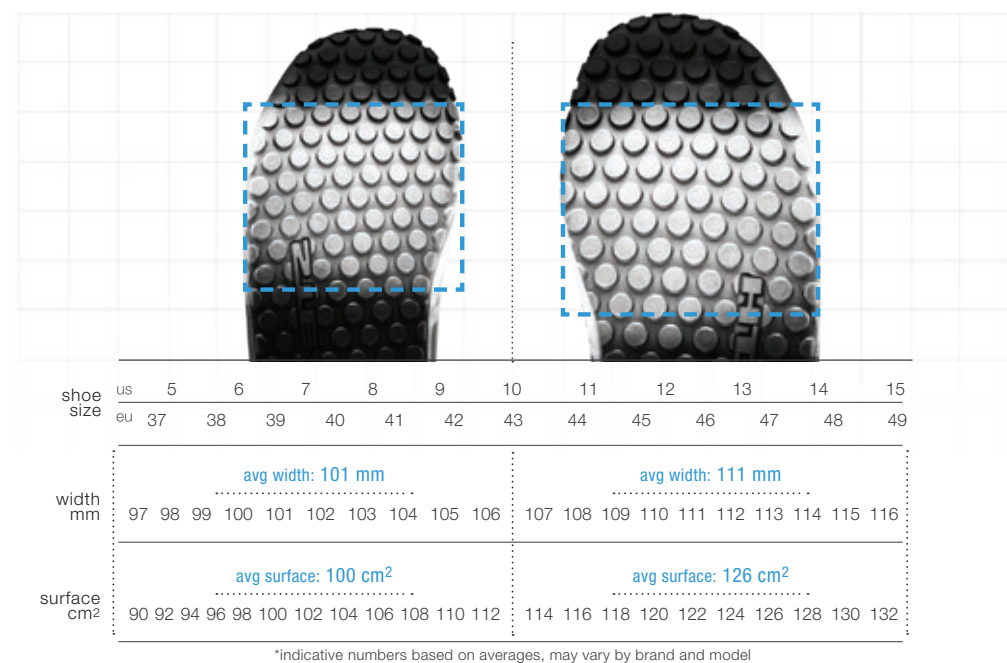

### OPTIMAL SURFACE AREA

- Based on research of shoe sizes & outsoles surfaces
- Two distinct sizes with optimal surface areas for different shoe size ranges
- Maximizes grip, support, and interface with pedal
- Minimizes necessary weight and rock-strikes

- Basierend auf der Recherche von Schuhgrößen & Sohlen Oberflächen
- Zwei unterschiedliche Größen mit optimaler Fläche für die verschiedenen Schuhgrößen
- Maximierter Grip, Support und bessere Verbindung mit dem Pedal
- Minimiertes Gewicht und Risiko von "rock strikes"

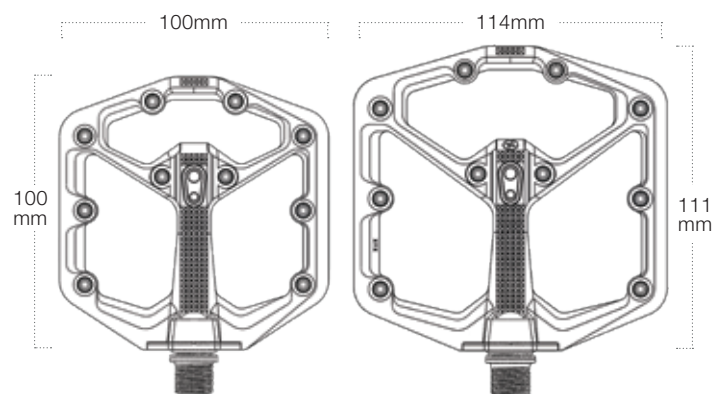

### MINIMUM PROFILE / MAXIMUM CONCAVITY | MINIMALES PROFIL / MAXIMALE KONKAVE

- Minimal profile, 11-13mm
- Thinner profile than the competition
- Reduces weight and rock strikes
- Concave platform cups the foot for secure foothold and better grip
- More concave than the competition

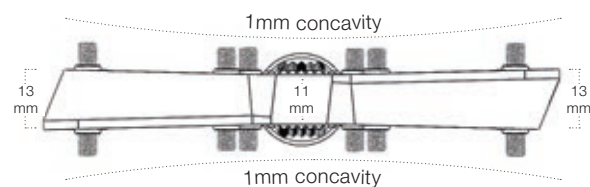

- Minimales Profil, 11-13mm
- Dünneres Profil als die Mitbewerber
- Reduziertes Gewicht und Gefahr von "rock strikes"
- Konkave Standfläche bettet den Fuß für sicheren Halt und besseren Grip
- Mehr Konkave als bei Mitbewerbern

## THE STAMP COLLECTION



### STAMP 11

### STAMP 7



	large black	small black	large black	small black	large red	small red
code	16165	16166	16002	16004	16003	16005
weight	325 g	299 g	375 g	345 g	375 g	345 g
price	€ 300	€ 300	€ 150	€ 150	€ 150	€ 150

### STAMP 3



	large black	small black	large blue	small blue	large Danny Macaskill	small Danny Macaskill
code	16102	16104	16103	16105	16213	16214
weight	455 g	399 g	455 g	399 g	455 g	399 g
price	€ 100	€ 100	€ 100	€ 100	€ 100	€ 100



# THE STAMP COLLECTION



## STAMP 2



// LIMITED EDITION

	large black	small black	large raw	small raw	large red	small red
code	16107	16109	16106	16108	16207	16208
weight	470 g	415 g	470 g	415 g	470 g	415 g
price	€ 80	€ 80	€ 80	€ 80	€ 80	€ 80

## STAMP 1

NEW



	large black	small black	large red	small red	large blue	small blue
code	16267	16270	16268	16271	16269	16272
weight	329 g	299 g	329 g	299 g	329 g	299 g
price	€ 50	€ 50	€ 50	€ 50	€ 50	€ 50

# THE 5050 COLLECTION



## 5050



	black/black
code	16219
weight	480 g
price	€ 60

# THE DOUBLE SHOT COLLECTION



## DOUBLE SHOT 3



flat side

clip side

flat side

clip side

	black	red/black
code	16111	16110
weight	403 g	403 g
price	€ 129	€ 129

# THE DOUBLE SHOT COLLECTION



## DOUBLE SHOT 2



	black/raw/blue	orange/black/orange	blue/black/black
code	16006	16007	16077
weight	395 g	395 g	395 g
price	€ 90	€ 90	€ 90

## DOUBLE SHOT 1

NEW



	black/black	red/black	blue/black
code	16179	16180	16181
weight	331 g	331 g	331 g
price	€ 60	€ 60	€ 60

# ACCESSORIES

### STANDARD RELEASE 60° FLOAT CLEAT



gold

RELEASE: 15°    FLOAT: 60°

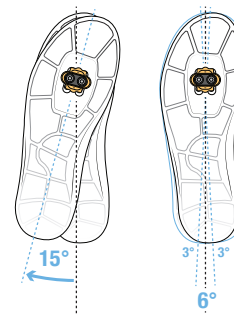

### STANDARD RELEASE 0° FLOAT CLEAT



silver

RELEASE: 15°    FLOAT: 0°

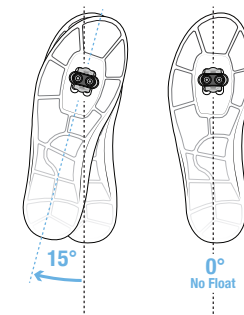

### EASY RELEASE 60° FLOAT CLEAT



rose

RELEASE: 10°    FLOAT: 60°

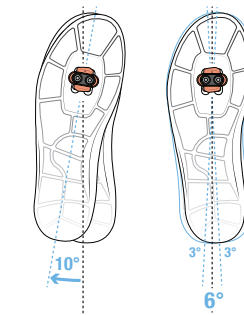

### EASY RELEASE 0° FLOAT CLEAT



bronze

RELEASE: 10°    FLOAT: 0°

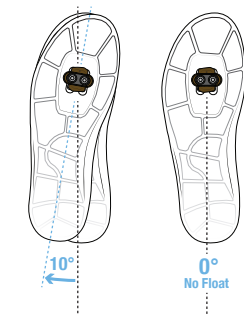

### CLEAT ACCESSORIES

accessory	code	weight	price
standard release cleat - 6° / 15°	10060	30g per pr	€ 24,50
standard release zero float cleat - 0° / 15°	15338	30g per pr	€ 24,50
3-hole cleat kit	15289	86g per pr	€ 30,00
NEW easy release cleat - 6° / 10°	16275	30g per pr	€ 24,50
NEW easy release zero float cleat - 0° / 10°	16276	30g per pr	€ 24,50
shoe shields (pair)	10000	36g per pr	€ 10,00

### SPINDLE UPGRADE KITS

kit	code	price
long spindle upgrade kit	16067	€ 50,00
titanium spindle upgrade kit	16068	€ 150,00

### PEDAL REFRESH KITS

kit	code	price
2010-present	16051	€ 22,50
NEW candy 11 / eggbeater 11	16229	€ 22,50
NEW stamp 7/11	16273	€ 22,50
NEW double shot 2/3	16274	€ 22,50

### TRACTION PADS

accessory	code	price
eggbeater 2/3/11	13281	€ 10,00
candy 2/3 (2010-2016)	13282	€ 10,00
candy 2/3 (2017+)	16217	€ 10,00
candy 7/11	16057	€ 15,00
mallet E / ELS / E11	16058	€ 15,00

### MALLET / 5050 / STAMP PIN KITS

kit	code	price
8 mm pin kits	13891	€ 12,00
10 mm pin kit	13890	€ 12,00

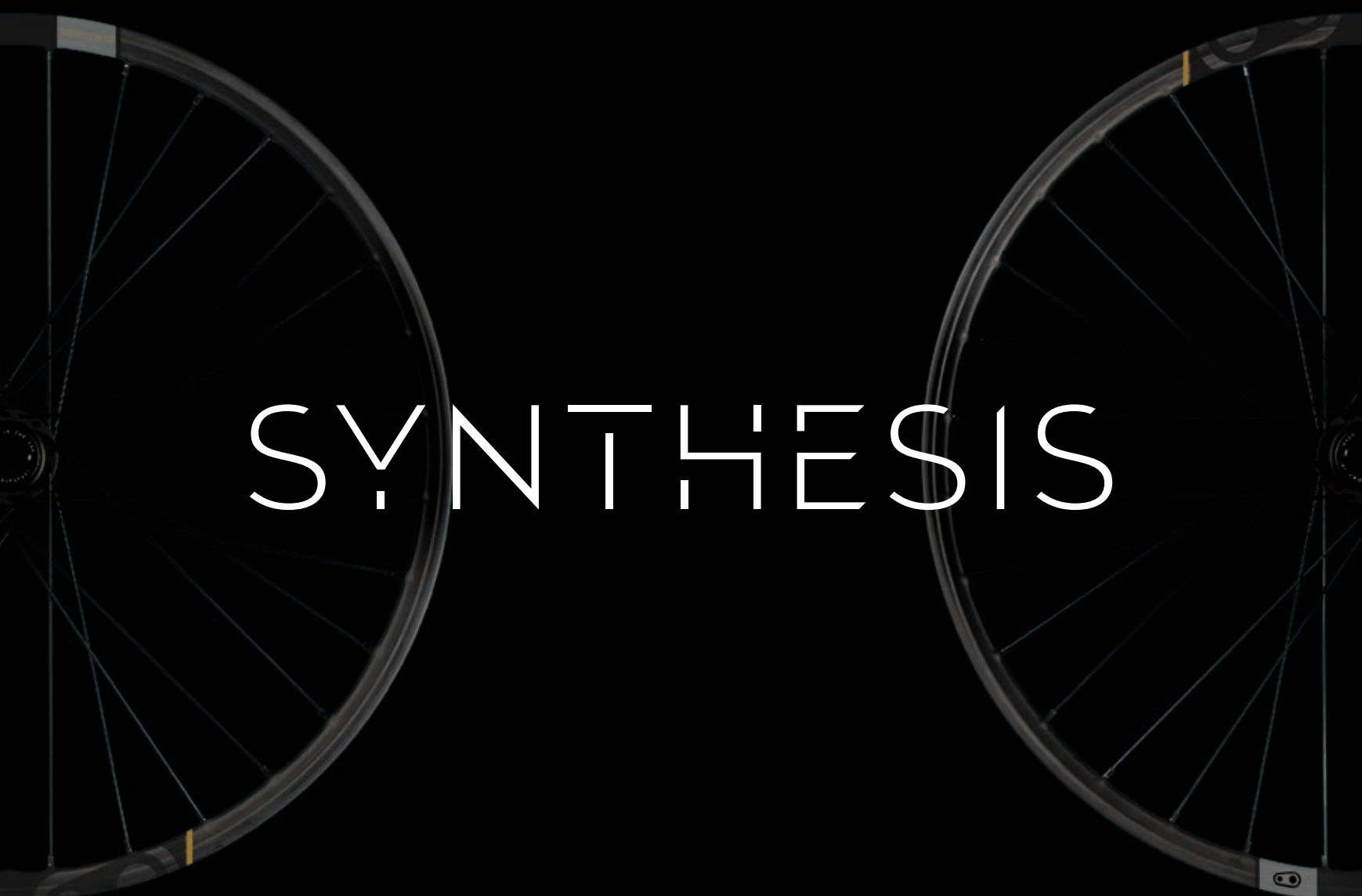

# SYNTHESIS

## TUNED CARBON WHEEL SYSTEM | TUNED CARBON WHEEL SYSTEM

### FRONT AND REAR SPECIFIC | VORDER-UND HINTERRAD SPEZIFISCH

#### FRONT MATRIX

- Reduced spoke count
- Lower spoke tension
- Lighter weight spoke
- Wider inner rim width
- Lighter rim
- Reduzierte Speichenanzahl
- Geringere Speichenspannung
- Leichtere Speichen
- Breiteres Felgeninnenmaß
- Leichtere Felge

#### REAR MATRIX

- Higher spoke count
- Higher spoke tension
- Increased weight spoke
- Narrower inner rim width
- Tougher rim
- Höhere Speichenanzahl
- Höhere Speichenspannung
- Schwerere Speichen
- Schmaleres Felgeninnenmaß
- Robustere Felge

### COMPLIANT FRONT WHEEL | NACHGIEBIGES VORDERRAD CONTROL IN TURNS | KONTROLLE IN KURVEN

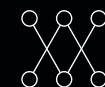

#### OPTIMIZE HANDLING VERBESSERTES HANDLING

- Reduce trail chatter
- Reduced rider fatigue
- Deflects and absorbs energy
- Reduziertes "trail chatter"
- Reduziert ermüden des Fahrers
- Nimmt Energie auf und leitet diese um

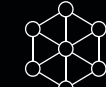

#### MAINTAIN CONTACT PATCH

- Improved grip
- Improved turning at speed
- Keeps tire connected to trail
- Verbesserter Grip
- Verbessertes Kurvenverhalten
- Hält die Verbindung zwischen Reifen und Trail

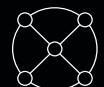

#### WIDER INNER RIM WIDTH BREITERES FELGENINNENMAß

- Increase tire volume for better contact
- Round tire profile to enhance turning
- Support wider tire profile in front
- Verbessert das Reifenvolumen für mehr Kontaktfläche
- Runderes Reifenprofil für einfacheres Kurvenfahren
- Unterstützt breitere Reifenprofile in der Front

### STIFF REAR WHEEL | STEIFES HINTERRAD STABILITY AND TRACKING AT SPEED | STABILITÄT UND SPURTREUE BEI GESCHWINDIGKEIT

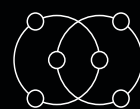

#### DIRECTIONAL / RADIAL LOADS SUPPORTED CORRECTLY DIREKTIONALE / RADIALE BELASTUNGEN RICHTIG UNTERSTÜTZT

- Responsiveness
- Maintain speed and momentum
- Stability
- Support peak loads
- Anchor riders center of gravity
- Reaktionsfreudig
- Geschwindigkeit und Momentum werden beibehalten
- Stabilität
- Support peak loads
- Festigt den Fahrerswerpunkt

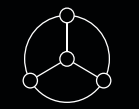

#### NARROWER INNER RIM WIDTH SCHMALERES FELGENINNENMAß

- Reduce contact patch
- Improve rolling resistance
- Dharpen tire profiles edge for grip
- Reduzierte Kontaktfläche
- Geringerer Rollwiderstand
- Verstärkt das äußere Reifenprofil für mehr Grip

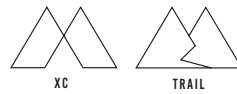

# SYNTHESIS XCT

NEW

PRECISE HANDLING AT FULL SPEED | PRÄZISES HANDLING AUCH BEI VOLLGAS

## SYNTHESIS XCT 11

HUB CRANKBROTHERS PROJECT 321

ENGAGEMENT 2.5° QUIET ENGAGEMENT / MAGNETIC PAWLS

SPOKES AERO CX RAY / CX SPRINT

## SYNTHESIS XCT

HUB CRANKBROTHERS STANDARD

ENGAGEMENT 17°

SPOKES DLIGHT / RACE



### FRONT WHEEL

SPOKE COUNT: 28 INNER RIM WIDTH: 26.5

### REAR WHEEL

SPOKE COUNT: 32 INNER RIM WIDTH: 24.5

### FRONT WHEEL

SPOKE COUNT: 28 INNER RIM WIDTH: 26.5

### REAR WHEEL

SPOKE COUNT: 32 INNER RIM WIDTH: 24.5

	synthesis XCT 11 : 29"	synthesis XCT 11 : 29"	synthesis XCT : 29"	synthesis XCT : 29"
code	16299	16300	16301	16302
driver body	xd	shimano	xd	shimano
weight	1473g	1490g	1557g	1557g
diameter	29"	29"	29"	29"
hub	boost	boost	boost	boost
front axle	110x15mm	110x15mm	110x15mm	110x15mm
rear axle	148x12mm	148x12mm	148x12mm	148x12mm
rim	carbon premium	carbon premium	carbon	carbon
price	€ 2400	€ 2400	€ 1699	€ 1699



# SYNTHESIS E

NEW

CONTROL & STABILITY FOR ENDURO RIDING | KONTROLLE & STABILITÄT FÜRS ENDURO FAHREN

## SYNTHESIS E 11

HUB CRANKBROTHERS PROJECT 321

ENGAGEMENT 2.5° QUIET ENGAGEMENT / MAGNETIC PAWLS

SPOKES AERO CX RAY / CX SPRINT

## SYNTHESIS E

HUB CRANKBROTHERS STANDARD

ENGAGEMENT 17°

SPOKES DLIGHT / RACE



### FRONT WHEEL

SPOKE COUNT: 28 INNER RIM WIDTH: 31.5

### REAR WHEEL

SPOKE COUNT: 32 INNER RIM WIDTH: 29.5

### FRONT WHEEL

SPOKE COUNT: 28 INNER RIM WIDTH: 31.5

### REAR WHEEL

SPOKE COUNT: 32 INNER RIM WIDTH: 29.5

	synthesis E 11 : 27.5"	synthesis E 11 : 27.5"	synthesis E 11 : 29"	synthesis E 11 : 29"	synthesis E : 27.5"	synthesis E : 27.5"	synthesis E : 29"	synthesis E : 29"
code	16285	16286	16289	16290	16287	16288	16291	16292
driver body	xd	shimano	xd	shimano	xd	shimano	xd	shimano
weight	1764g	1785g	1829g	1829g	1848g	1848g	1908g	1908g
diameter	27.5"	27.5"	29"	29"	27.5"	27.5"	29"	29"
hub	boost	boost	boost	boost	boost	boost	boost	boost
front axle	110x15mm	110x15mm	110x15mm	110x15mm	110x15mm	110x15mm	110x15mm	110x15mm
rear axle	148x12mm	148x12mm	148x12mm	148x12mm	148x12mm	148x12mm	148x12mm	148x12mm
rim	carbon premium	carbon premium	carbon premium	carbon premium	carbon	carbon	carbon	carbon
price	€ 2400	€ 2400	€ 2400	€ 2400	€ 1699	€ 1699	€ 1699	€ 1699

WHEELSETS



# SYNTHESIS DH 11

NEW

OPTIMIZED TO EXCEED LIMITS | OPTIMIERT UM LIMITS ZU ÜBERSCHREITEN

## SYNTHESIS DH 11

HUB CRANKBROTHERS PROJECT 321

ENGAGEMENT 2.5° QUIET ENGAGEMENT / MAGNETIC PAWLS

SPOKES AERO CX RAY / CX SPRINT



FRONT WHEEL

SPOKE COUNT: 32  
INNER RIM WIDTH: 31.5



REAR WHEEL

SPOKE COUNT: 32  
INNER RIM WIDTH: 31.5

	synthesis DH 11 : 27.5"	synthesis DH 11 : 27.5"	synthesis DH 11 : 27.5"	synthesis DH 11 : 27.5"	synthesis DH 11 : 29"	synthesis DH 11 : 29"
code	16293	16294	16295	16296	16297	16298
driver body	xd	shimano	xd	shimano	xd	shimano
weight	1955g	1955g	1955g	1955g	2049g	2049g
diameter	27.5"	27.5"	27.5"	27.5"	29"	29"
hub	boost	boost	standard	standard	boost	boost
front axle	110x15mm	110x15mm	110x20mm	110x20mm	110x15mm	110x15mm
rear axle	148x12mm	148x12mm	150x12mm	150x12mm	148x12mm	148x12mm
rim	carbon premium	carbon premium	carbon premium	carbon premium	carbon premium	carbon premium
price	€ 2400	€ 2400	€ 2400	€ 2400	€ 2400	€ 2400





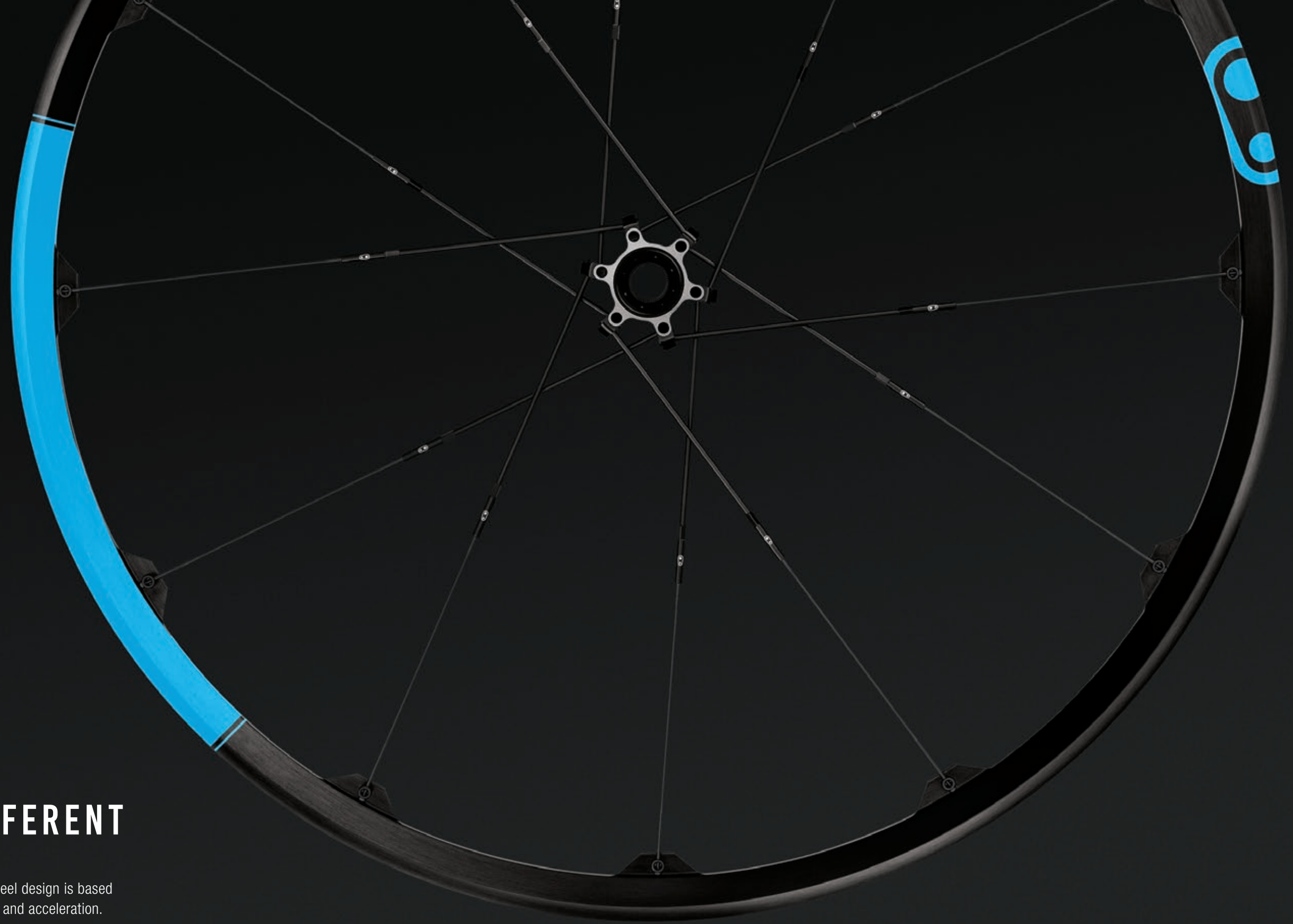

## MASSIVELY DIFFERENT

Simple and beautiful, our unique alloy wheel design is based around principles of strength, stiffness, and acceleration.

---

### WESENTLICH ANDERS

Einfach und schön, unser einzigartiges Aluminium Laufrad Design basiert auf den Grundlagen von Stabilität, Steifigkeit und Beschleunigung.

**FASTER TO ACCELERATE / DECELERATE  
SCHNELLERES BESCHLEUNIGEN / ABBREMSEN**

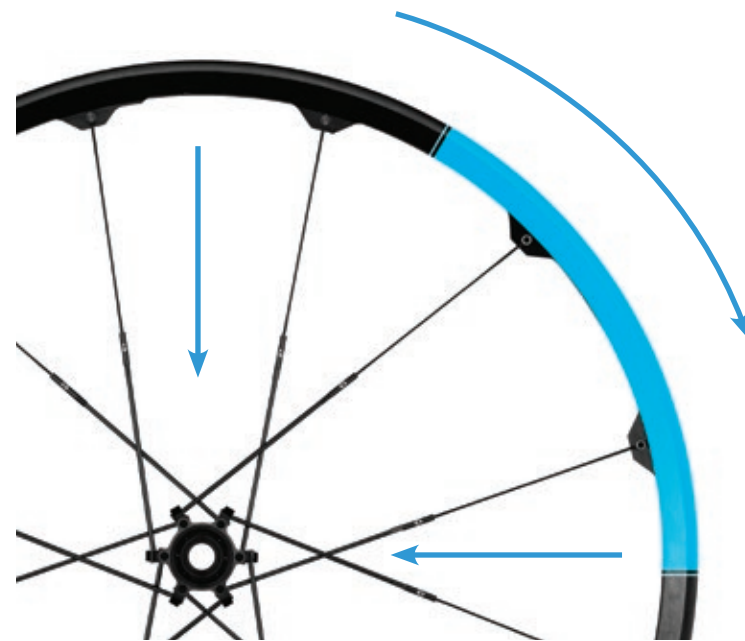

**LOW ROTATIONAL INERTIA**

Unique wheel design distributes mass closer to the hub for faster acceleration and deceleration.

**TUBELESS READY**

Hole-less rims: stronger and no rim tape required for tubeless setup.

**NIEDRIGE ROTATIONSTRÄGHEIT**

Das einzigartige Laufrad Design verteilt die Masse näher zum Nabenkörper für ein schnelleres Beschleunigen und Abbremsen.

**TUBELESS READY**

Lochlose Felge: stabiler und es wird kein Felgenband benötigt für ein Tubeless Setup.

**STRONGER AND STIFFER | STABILER UND STEIFER**

**TWINPAIR SPOKE TECHNOLOG**

Designed using the strongest shape in construction, the triangle, to maximize strength and stiffness.

**BEAUTIFULLY SIMPLE**

Single spoke length: easy to true and replaceable without removing tire.

**TWINPAIR SPEICHEN TECHNOLOGIE**

Designed mit der stabilsten Form im Aufbau, dem Dreieck, für ein Maximum an Haltbarkeit und Steifigkeit.

**WUNDERBAR EINFACH**

Einheitliche Speichenlänge: einfaches zentrieren und austauschbar ohne den Reifen zu entfernen.



**WIDER RIM PROFILE | BREITERES FELGEN PROFIL**

WIDER RIM PROFILE FOR A BETTER TRACTION | BREITERES FELGEN PROFIL FÜR EINE VERBESSERTE TRAKTION



**RIM WIDTH**

The perfect balance of width and weight allows maximum traction for a wide range of tire widths.

**OPTIMAL TIRE PROFILES**

Increased air volume for better cushioning, maximum tread contact improves traction for braking, climbing and cornering.

**FELGENBREITE**

Die perfekte Balance zwischen Breite und Gewicht ermöglicht eine maximale Traktion für eine große Auswahl an Reifenbreiten.

**OPTIMALES REIFENPROFIL**

Erhöhtes Luftvolumen für eine bessere Dämpfung. Maximaler Stollen Kontakt für eine verbesserte Traktion beim Bremsen, Klettern und in Kurven.

**IMPROVED HUB | VERBESSERTE NABE**

REDUCED WEIGHT, FASTER ASSEMBLY | GEWICHTSREDUZIERT, SCHNELLERE MONTAGE

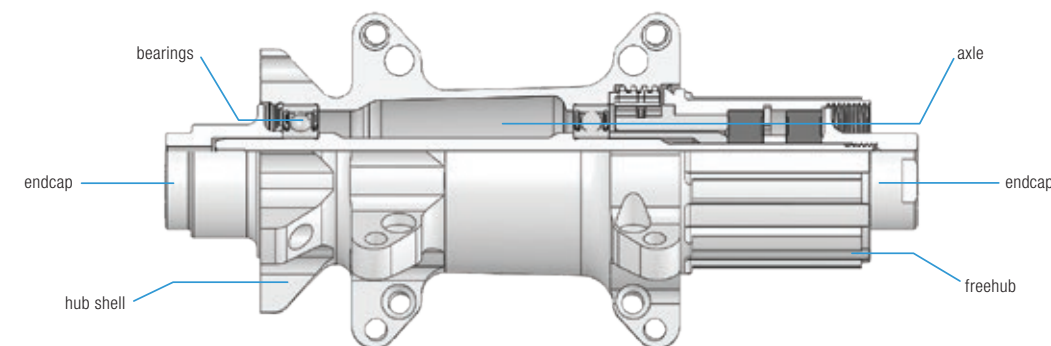

**REDUCED WEIGHT**

Significant weight modifications through material reductions in key areas including bearings, endcaps, hub shell, freehub and axle.

**GEWICHTSREDUZIERT**

Signifikante Gewichtsreduzierung durch Wegnahme von Material an den Schlüsselstellen wie z.B. Lagern, Endkappen, Nabenkörper, Freilauf und Achsen.

## LITHIUM

BUILT FOR E-MTB

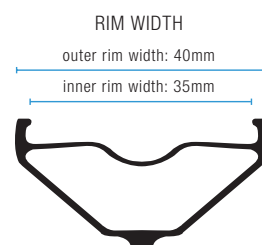

NEW

## LITHIUM 27.5+



ELECTRIC

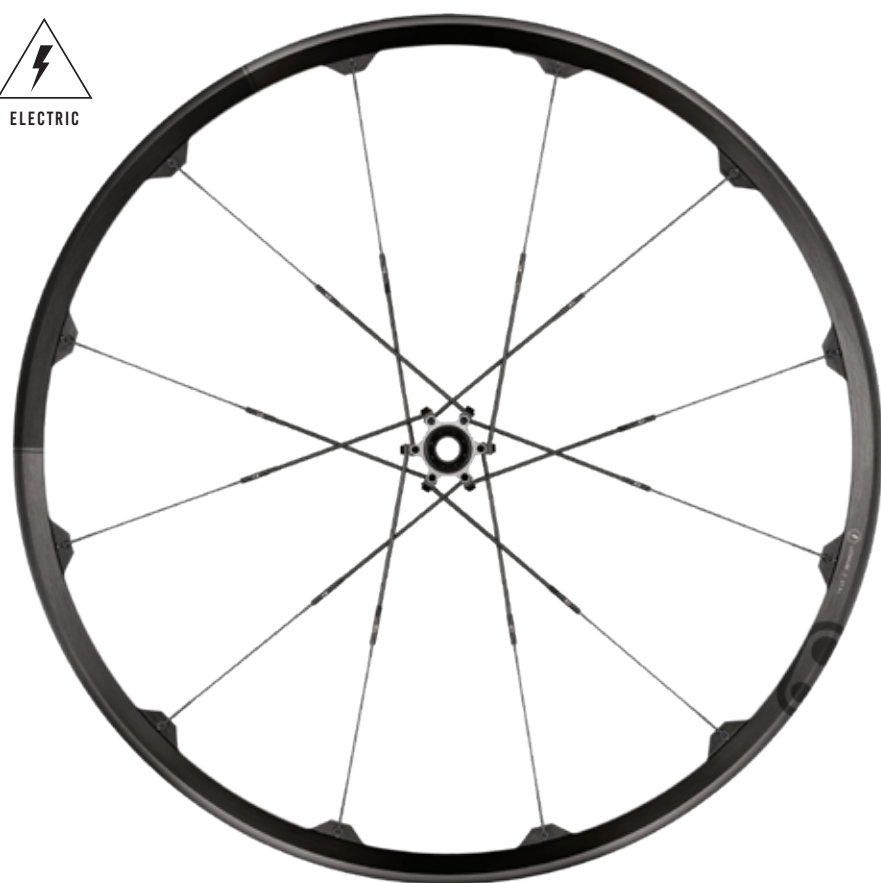

## KEY FEATURES:

- 2.0 straight gauge spokes
- 35mm inner / 40mm outer rim width
- reinforced rim profile
- steel free-hub body
- boost front/rear
- tubeless ready
- 2 year warranty

## HAUPTMERKMALE:

- stabilere Speichen – 2.0 straight gauge
- breiteres Felgen Profil (35mm innen/40mm außen)
- Freilauf und Achse aus Stahl
- twin pair Speichen Technologie
- verstärktes Felgen Profil
- tubeless ready
- 2 Jahre Garantie

## BENEFITS OF E-BIKE SPECIFIC WHEELS | VORTEILE VON E-BIKE SPEZIFISCHEN LAUFRÄDERN

WHEN COMPARED TO STANDARD MOUNTAIN BIKES, AN E-BIKE'S WEIGHT INCREASES & POWER INCREASES, WHICH REQUIRES A STRONGER AND MORE ROBUST WHEEL SYSTEM.

VERGLICHEN ZU EINEM STANDARD MTB, BESITZT EIN E-BIKE DEUTLICH MEHR GEWICHT UND AUCH POWER, WAS EIN STABILERES UND ROBUSTERES LAUFRAD SYSTEM ERFORDERT.

	lithium 27.5 +
code	16249
color	gloss black/black
weight	2085 g
diameter	27.5"
front axle	15x110 mm
rear axle	148x12 mm
price	€ 779

## COBALT 3

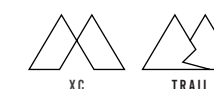

RIM WIDTH  
outer rim width: 27.5mm  
inner rim width: 23mm



## COBALT 3, ALUMINUM

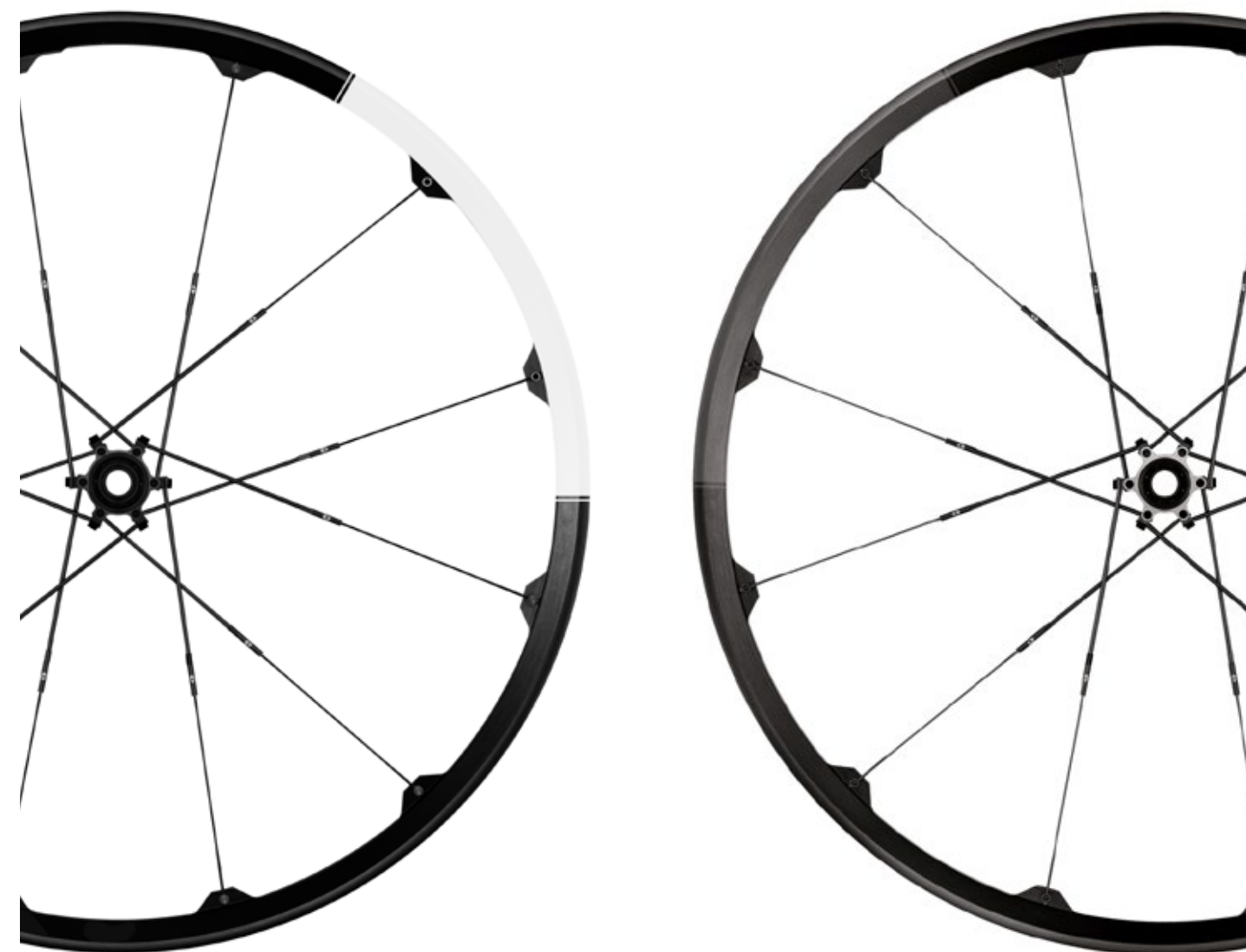

	cobalt 3 : 29"	cobalt 3 boost : 29"	cobalt 3 boost : 27.5"	cobalt 3 : 29"	cobalt 3 boost : 29"	cobalt 3 : 27.5"
code	16127	16129	16130	16155	16156	16157
color	black/white	black/white	black/white	matt black/black	matt black/black	matt black/black
weight	1735 g	1735 g	1650 g	1735 g	1735 g	1650 g
diameter	29"	29"	27.5"	29"	29"	27.5"
front axle	15x100 mm	15x110 mm	15x110 mm	15x100 mm	15x110 mm	15x110 mm
rear axle	142x12 mm	148x12 mm	148x12 mm	142x12 mm	148x12 mm	148x12 mm
price	€ 779	€ 779	€ 779	€ 779	€ 779	€ 779

# COBALT 2

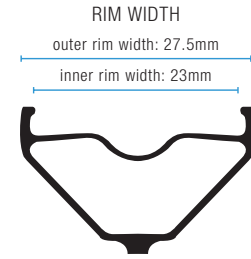
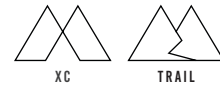

## COBALT 2, ALUMINUM



	cobalt 2 : 29"	cobalt 2 boost : 29"	cobalt 2 boost : 27.5"
code	16140	16141	16142
color	black/grey	black/grey	black/grey
weight	1790 g	1790 g	1710 g
diameter	29"	29"	27.5"
front axle	15x100 mm	15x110 mm	15x110 mm
rear axle	142x12 mm	148x12 mm	148x12 mm
price	€ 579	€ 579	€ 579

# COBALT 1

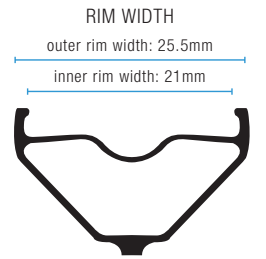
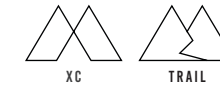

## COBALT 1, ALUMINUM



	cobalt 1 : 29"	cobalt 1 : 27.5"
code	15876	15875
color	flat black	flat black
weight	1975 g	1900 g
diameter	29"	27.5"
front axle	15x100 mm	15x100 mm
rear axle	142x12 mm	142x12 mm
price	€ 399	€ 399

# IODINE 3

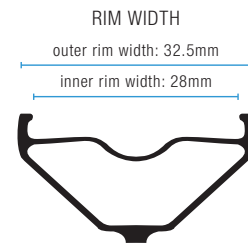

## IODINE 3, ALUMINUM



	iodine 3 boost : 29"	iodine 3 : 27.5"	iodine 3 boost : 27.5"
code	16137	16136	16138
color	black/silver	black/silver	black/silver
weight	1830 g	1760 g	1760 g
diameter	29"	27.5"	27.5"
front axle	15x110 mm	15x100 mm	15x110 mm
rear axle	148x12 mm	142x12 mm	148x12 mm
price	€ 779	€ 779	€ 779

# IODINE 2

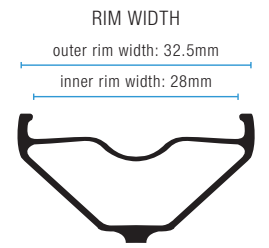

## IODINE 2, ALUMINUM



	iodine 2 boost : 29"	iodine 2 : 27.5"	iodine 2 boost : 27.5"
code	16143	16144	16145
color	black/grey	black/grey	black/grey
weight	1900 g	1830 g	1830 g
diameter	29"	27.5"	27.5"
front axle	15x110 mm	15x100 mm	15x110 mm
rear axle	148x12 mm	142x12 mm	148x12 mm
price	€ 579	€ 579	€ 579

# OPIUM



DOWNHILL

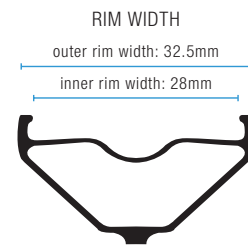

## OPIUM DH, ALUMINUM



	opium : 29"	opium : 27.5"
code	16196	16190
color	black/red	black/red
weight	2175 g	2075 g
diameter	29"	27.5"
front axle	20x110 mm	20x110 mm
rear axle	150x12 mm	150x12 mm
price	€ 779	€ 779

# ZINC 3



CYCLOCROSS

XC

TRAIL

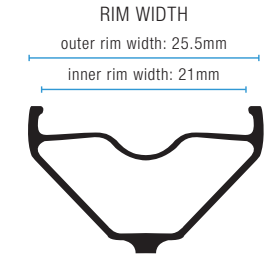

## ZINC 3, ALUMINUM



	zinc 3 : 29"
code	16139
color	black/white
weight	1645 g
diameter	29"
front axle	15x100 mm
rear axle	142x12 mm
price	€ 779

### WHEELSETS ACCESSORIES\*

wheel kit	XC driver body for level 2, 3 & 11 (from range 2017)	Front adaptors for Cobalt, Iodine, Zinc			Rear adaptors for Cobalt, Iodine level 3/11	
		9 mm	15 mm	100X12 mm (+ axle kit)	135X10 mm	142X12 mm
codice	15538	99202	99203	99162	99204	99205
prezzo	€ 100	€ 20	€ 20	€ 20	€ 20	€ 20

\* refer to price list for more options // weitere Optionen können der Preisliste entnommen werden



## HIGHLINE DROPPER SEATPOST | HIGHLINE DROPPER SATTELSTÜTZE

Premium Trelleborg sealing, exclusive igus bearings and keys, Jagwire cable, and a self contained hydraulic cartridge deliver industry leading quality and reliability. New for 2018: shorter insertion lengths and the addition of 150mm & 170mm travel options.

Die premium Trelleborg Dichtung, exklusive Igus Lager und Buchsen, Jagwire Kabelzüge und eine in sich geschlossene, hydraulische Kartusche bieten eine in der Industrie führende Qualität und Zuverlässigkeit. Neu für 2018: kürzere Einbaulänge und ergänzt um die Option 150mm & 170mm Federweg.

- infinite travel adjustment
- Diameter: 30.9, 31.6mm
- 47mm minimum stack height
- Internal routing
- Quick-connect mechanism for ease of cable installation
- Two-bolt quick release head for easy saddle installation
- Jagwire® elite ultra-slick cable and lex-sl housing
- Self contained hydraulic cartridge
- Igus® LL-glide bearing and keys
- Trelleborg® seal
- 3 year warranty

- Stufenlos Höhenverstellbar
- Durchmesser: 30.9, 31.6mm
- 47mm minimum stack height
- Interne Kabelführung
- Quick-connect für einfache Kabel Installation
- Two-bolt quick release für einfache Sattel Montage
- Jagwire® elite ultra-slick Kabel und Lex-sl Zughülle
- Geschlossene, hydraulische Kartusche
- Igus® LL- Gleitlager und Buchsen
- Trelleborg® Dichtung
- 3 Jahre Garantie



NEW NEW NEW NEW

code	16163	16164	16008	16009	16241	16240	16243	16242
color	black	black	black	black	black	black	black	black
weight	510g*	520g*	550g*	560g*	585g*	595g*	615g*	625g*
diameter	30,9 mm	31,6 mm	30,9 mm	31,6 mm	30,9 mm	31,6 mm	30,9 mm	31,6 mm
length	325 mm	325 mm	370 mm	370 mm	425 mm	425 mm	465 mm	465 mm
travel	100 mm	100 mm	125 mm	125 mm	150 mm	150 mm	170 mm	170 mm
price	€ 350	€ 350	€ 350	€ 350	€ 350	€ 350	€ 350	€ 350

\*Weight includes post, remote and cable. Housing adds 25-60g based on length.

\*Die Gewichtsangabe umfasst Stütze, Schalthebel und Schaltzug. Je nach Länge der Außenhülle kommen 25-60g hinzu.

## WORLD'S MOST ERGONOMIC REMOTE | DER WELTWEIT ERGONOMISCHSTE REMOTE HEBEL

The highline remote features a unique spherical adjustment, with near-infinite rotation and tilt customization options, for perfect cockpit ergonomics.

Dank des einmaligen Kugelkopf Designs bietet der Highline Remote Hebel nahezu unbegrenzte Möglichkeiten in der Anpassung, um somit eine perfekte Ergonomie am Cockpit zu erhalten.

- Pivot remote lever allows optimal ergonomic placement
- Ergonomic spherical adjustment: 360° rotation / 22° tilt
- Single bolt hinge locking system
- Universal mounting system: top / bottom / left / right

- Remote Hebel kann bestmöglich ergonomisch angebracht werden
- Ergonomisch anpassbarer Kugelkopf: 360° Rotation / 22° Neigung
- Single bolt Gelenkverbindung
- Universelles Befestigungs System: oben / unten / links / rechts



### HIGHLINE TRACTION TABS

Customize your grip / Available in a variety of colors  
Customize deinen Griff / Verfügbar in einer Vielzahl an Farben



	HIGHLINE remote only	HIGHLINE stickers kit
code	16066	16150
color	black	mixed colours
price	€ 60	€ 8



# COBALT 11

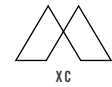

## COBALT 11 20 MM SETBACK

## COBALT 11 NO SETBACK



	27.2 mm - 400 mm	27.2 mm - 400 mm
code	15486	15485
color	black/gold	black/gold
price	€ 220	€ 220
	30.9 mm - 400 mm	30.9 mm - 400 mm
code	15490	15489
color	black/gold	black/gold
price	€ 220	€ 220
	31.6 mm - 400 mm	31.6 mm - 400 mm
code	15494	15493
color	black/gold	black/gold
price	€ 220	€ 220
weight	157 g (31.6 mm, no setback, 350 mm)	

# COBALT 3

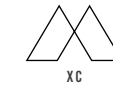

## COBALT 3 20 MM SETBACK

## COBALT 3 NO SETBACK



	27.2 mm - 400 mm	27.2 mm - 400 mm
code	15472	15471
color	black/red	black/red
price	€ 100	€ 100
	30.9 mm - 400 mm	30.9 mm - 400 mm
code	15474	15473
color	black/red	black/red
price	€ 100	€ 100
	31.6 mm - 400 mm	31.6 mm - 400 mm
code	15476	15475
color	black/red	black/red
price	€ 100	€ 100
weight	234 g (31.6 mm, no setback, 350 mm)	

# COBALT

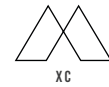

## COBALT 11, CARBON



	680 mm
code	14899
height	low rise (15 mm)
weight	160 g (680 mm low rise)
color	black polish
price	€ 160

## COBALT 3, ALUMINUM



	680 mm	700 mm	780 mm
code	14883	14897	14886
height	rise (8 mm)	rise (15 mm)	rise (8 mm)
weight	180 g (600 mm flat)	230 g (600 mm low rise)	180 g (600 mm flat)
color	black	black	black
price	€ 85	€ 85	€ 85

# IODINE



## IODINE 11, CARBON



	780 mm
code	14913
height	rise (31,8 mm)
weight	215 g
color	black
price	€ 160

## IODINE 3, ALUMINUM

## IODINE 2, ALUMINUM



	720 mm	780 mm
code	14908	15381
height	rise (31,8 mm)	rise (31,8 mm)
weight	290 g	360 g
color	black	black
price	€ 85	€ 50

## COBALT &amp; IODINE

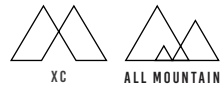

## COBALT



130 mm

code	15279
weight	65 g
color	silver
price	€ 25



130 mm

code	14918
weight	65 g
color	gold
price	€ 25



130 mm

code	14919
weight	65 g
color	red
price	€ 25

## IODINE



130mm

code	14920
weight	101 g
color	black
price	€ 25



# THIN, LIGHT, MINIMALIST

F-ing fantastic. Folding flat to fit almost anywhere, the new f-series tools feature ultra-fine finishing and up to fifteen fundamental tools fixed inside a magnetic case.

## DÜNN, LEICHT, MINIMALISTISCH

F...ing fantastisch. Flach gefaltet um beinahe überall hinein zu passen. Die neuen f-Series Werkzeuge besitzen ein ultra feines Finish und beherbergen bis zu 15 wichtige Werkzeuge, alles untergebracht in einem magnetischen Case.

# MULTI TOOLS

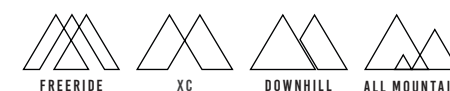

## F-SERIES



// LIMITED EDITION

	f15 SYNDICATE red case	f15	f10+	f10
code	16227	16092	16091	16090
weight	164 g	164 g	116 g	94 g
price	€ 43	€ 43	€ 35	€ 30

## B-SERIES



	b14	b8
code	14688	14687
weight	206 g	144 g
price	€ 28	€ 20

# MULTI TOOLS

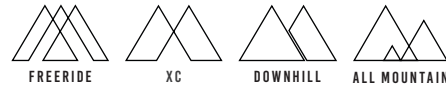

## M-SERIES



	m19 (includes tool flask)	m17	m10	m5
code	10758	10755	10750	10745
weight	175 g w/out flask	168 g	124 g	85 g
color	gold	gold	gold	gold
price	€ 34	€ 28	€ 20	€ 13



	m19 (includes tool flask)	m17	m10	m5
code	11465	10752	10747	10743
weight	175 g w/out flask	168 g	124 g	85 g
color	nickel	nickel	nickel	nickel
price	€ 34	€ 28	€ 20	€ 13

## Y16

## Y15

## Y12



	y16	y15	y12
code	15743	15938	15742
weight	260 g	224 g	166 g
color	silver	silver	silver
price	€ 50	€ 40	€ 30

# MULTI TOOLS - LEVERS

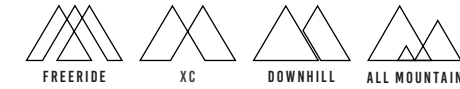

## SEATPOST RAIL KIT

	7x9 seatpost rail kit
code	13780
color	black
price	€ 30



## SPEEDIER LEVER

code	14499
weight	26 g
price	€ 6



## SPEEDIER LEVER POP

code	14532
price	€ 144 / € 6 cad.
code	14498
price	€ 144 / € 6 cad.



# THE WORKSHOP ESSENTIAL

Featuring a hidden hose, magnetic head and removable burst tank, our klic floor pumps are the perfect shop or home addition for effortless tubeless setup and pinpoint accuracy.

## IN DER WERKSTATT UNENTBEHRLICH

Versteckter Schlauch, magnetischer Pumpenkopf und abnehmbarer Burst Tank, unsere klic Standpumpen sind die perfekte Ergänzung in jeder Werkstatt oder für zu Hause, für eine einfache tubeless Montage und punktgenauen Reifendruck.



## KLIC FLOOR PUMP | KLIC STANDPUMPE

- Magnetic hose attachment
- Hidden hose in the body of the floor pump
- Quick connect for gauge to be mounted to pump
- Hose is magnetically held inside the pump
- Tripod base for added stability
- Burst tank can hold 160 psi / 11 bar
- Universal head for presta/schrader
- Large, accurate digital or analog gauge
- Burst tank can be charged to install and inflate tubeless tires with ease
- Tank is removable for easy transport

- Magnetischer Schlauch Anschluss
- Versteckter Schlauch im Pumpenkörper
- Schnellverschluss um Manometer anzubringen
- Schlauch wird magnetisch im Pumpenkörper aufbewahrt
- Dreibein Standfuß für verbesserte Stabilität
- Burst Tank hält bis zu 160 psi / 11 bar
- Universeller Pumpenkopf für Presta/Schrader
- Großes, genaues digital oder analog Manometer
- Burst Tank kann aufgeladen werden, für einfaches montieren und befüllen von Tubeless Reifen
- Der Tank ist abnehmbar für einen einfachen Transport

### REMOVABLE BURST TANK ABNEHMBARER BURST TANK

Install and inflate tubeless tires with ease.

Tubeless Reifen mit Leichtigkeit montieren und befüllen.



### HIDDEN HOSE VERSTECKTER SCHLAUCH

Stores neatly away in the pump body when not in use.

Lässt sich bei Nichtgebrauch platzsparend im Pumpenkörper verstauen.



### MAGNETIC QUICK-CONNECT MAGNETISCHER SCHNELLVERSCHLUSS

Easy interface for hose and burst tank.

Einfache Verbindung von Schlauch und Burst Tank.



## KLIC



NEW

pump w/digital gauge + canister



pump w/analog gauge + canister



only pump w/analog gauge

code	16197	16198	16200
weight	160 psi / 11 bar	160 psi / 11 bar	160 psi / 11 bar
price	€ 230	€ 200	€ 100

## STERLING FLOOR PUMP | STERLING STANDPUMPE

- Foot activated high pressure / high volume switch
- Lightweight alloy base for stability
- Corrosion resistant aluminum body and base
- Smart head: presta & schrader ready
- Bar / psi gauge

- High Pressure / High Volume einstellbar über Fußschalter
- Leichte, stabile Aluminium Standplatte
- Rostfreier Aluminiumkörper
- Smart head: Presta & Schrader ready
- Bar / psi Anzeige

## STERLING



silver

code	16168
weight	160 psi / 11 bar
head	universal presta / schrader
base	alloy
price	€ 70

## SAPPHIRE

NEW



silver

midnight black

code	16304	16303
weight	160 psi / 11 bar	160 psi / 11 bar
head	universal presta / schrader	universal presta / schrader
base	steel	steel
price	€ 50	€ 50

## GEM



black



green



red

code	16218	16206	16205
weight	160 psi / 11 bar	160 psi / 11 bar	160 psi / 11 bar
head	2 stage presta/schrader	2 stage presta/schrader	2 stage presta/schrader
base	steel	steel	steel
price	€ 50	€ 50	€ 50

## KLIC HAND PUMP | KLIC HANDPUMPE

- Hidden flexible hose inside (all models)
- Magnetic head with twisting collar to keep out dirt and debris
- Magnetic hose end to attach hose to head quickly and easily
- Presta and schrader ready
- Folding and locking handle on all models
- Gauge incorporated on select models
- CO2 adaptor incorporated into handle on select models
- All pumps come with frame mounting bracket
- 5 Year warranty

- Versteckter, flexibler Schlauch (in allen Modellen enthalten)
- Magnetischer, abgewinkelter Pumpenkopf beugt Verschmutzung vor
- Magnetisches Ende für einfache und schnelle Montage
- Presta und Schrader ready
- Falt- und arretierbarer Griff an allen Modellen
- Ausgewählte Modelle mit Manometer
- CO2 Adapter im Griff an ausgewählten Modellen
- Alle Pumpen werden mit einem Rahmenhalter ausgeliefert
- 5 Jahre Garantie

### PRESTA / SCHRADER READY

Unscrew and flip the head to switch between Presta and Schrader.

Durch einfaches umdrehen zwischen Presta & Schrader wechseln.



### TIRE PRESSURE GAUGE | REIFENDRUCK ANZEIGE

Highly accurate and easy to read gauge on select models.

Sehr akkurate und gut ablesbare Anzeige.

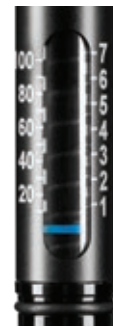

### MAGNETIC HEAD WITH TWISTING COLLAR MAGNETISCHER, ABGEWINKELTER PUMPENKOPF

Magnetic head with twisting collar to keep out dirt and debris. Magnetic hose end to attach hose to head quickly and easily.

Der magnetische, abgewinkelte Pumpenkopf beugt Verschmutzung vor. Magnetische Anschlüsse für einfache und schnelle Montage.



### HIDDEN, FLEXIBLE HOSE & LOCKING HANDLE W/ CO2 ADAPTER VERSTECKTER, FLEXIBLER SCHLAUCH

Folding handle unlocks to reveal hidden hose. magnetic head with twisting collar to keep out dirt and debris. CO2 head integrated on select models.

Verdeckter Schlauch unter dem Klappgriff. Magnetischer, abgewinkelter Pumpenkopf beugt Verschmutzung vor. Integrierter CO2 Anschluss an ausgewählten Modellen.



## THE KLIC HAND PUMP COLLECTION | THE KLIC HANDPUMPEN KOLLEKTION

### KLIC HP



	hp	hp gauge	hp w/co2	hp gauge w/co2 inflator
code	16112	16114	16216	16116
weight	115 g	142 g	142 g	170 g
color	silver/black	silver/black	silver/black	silver/black
price	€ 37	€ 47	€ 47	€ 57

### KLIC HV



	hv	hv gauge	hv w/co2	hv gauge w/co2 inflator
code	16113	16115	16215	16117
weight	124 g	150 g	142 g	186 g
color	silver/black	silver/black	silver/black	silver/black
price	€ 37	€ 47	€ 47	€ 57



## HAND PUMPS

### THE STERLING HAND PUMP COLLECTION | THE STERLING HANDPUMPEN KOLLEKTION

Premium pumps featuring a patented high volume / high pressure switch for easy inflation, with a smart head that automatically adjusts to schrader or presta. Available in two colors, with or without a gauge.

Diese premium Pumpen verfügen über ein patentiertes High Volume/High Pressure Wahlschalter, der ein einfaches Befüllen ermöglicht. Unser Smart Head Pumpenkopf wechselt automatisch zwischen Presta und Schrader Ventil. Verfügbar in zwei Farben, mit oder ohne Manometer.

#### STERLING GAUGE LONG



sterling lg

code	14679
weight	173 g
color	silver/black
price	€ 50

#### STERLING GAUGE SHORT



sterling sg

code	14677
weight	141 g
color	silver/black
price	€ 45

#### STERLING NO GAUGE LONG



sterling l

code	14678
weight	143 g
color	silver/black
price	€ 40

#### STERLING NO GAUGE SHORT



sterling s

code	14676
weight	116 g
color	silver/black
price	€ 35

Schrader / Presta convertible head and patented high pressure / high volume switch for easy inflation.

Schrader / Presta Pumpenkopf und patentierter High Pressure / High Volume Wahlschalter für einfaches Befüllen.

#### GEM L



green

code	14686
weight	155 g
price	€ 28



silver

code	14682
weight	155 g
price	€ 28



red

code	14684
weight	155 g
price	€ 28

#### GEM S



green

code	14685
weight	128 g
price	€ 22



silver

code	14681
weight	128 g
price	€ 22



red

code	14683
weight	128 g
price	€ 22

C02  
// NEW



#### C02

NEW



C02 16g cartridge

C02 25g cartridge

C02 16g bulk pack

C02 25g bulk pack

code	16230	16232	16233	16235
quantity	(2 units) w/inflator	(2 units) w/inflator	30 pieces	20 pieces
price	€ 16	€ 20	€ 90	€ 100



Continental 

AG2R LA  
MONDIALE

ROSTI

FACTOR

CONTINENTAL  
SPECIAL SERVICE COURSES

MAVIC

fizik

SRM POWER

COMPETITION  
MAVIC

## TECHNOLOGY MADE IN GERMANY



Continental, the only German manufacturer of tyres in Germany. "Handmade in Germany" denotes that the tyres are produced in our Korbach plant, mostly by hand and with a high proportion of manual labour from tyre design to the final quality control. For you this means offering your customers tyres with German technology - a tradition since 1871. Products made in Korbach are marked with the respective symbol on the following pages.



With our unique tread compound, which is produced only in Germany, we have revolutionised the sport of cycling. With the legendary BlackChili Compound we have answered the eternal question of the best balance of grip and rolling resistance for cycling. Regular test wins confirm the measurable and noticeable advantages for the cyclist, established in the laboratory and on the road. The latest polymers as well as specially developed carbon black particles and filler materials guarantee unique performance, be it on a road or a mountain bike, for time trialling or downhill. In contrast to conventional silica compounds: more mileage [+5 %]; improved rolling resistance by 26 % while grip is enhanced by 30 % at the same time; consistent handling characteristics from the first to the last kilometre.



The reference for puncture protection: Vectran™ is spun from liquid crystal-polymer. This way a thermoplastic, multiple-thread yarn is created. As a comparison: This partially crystalline fabric is more cut-resistant than aramide and its tensile strength is five- times higher than that of steel. A Vectran™ Breaker is lighter, more flexible and effective against cuts than a comparable nylon breaker. There is no detrimental effect on rolling resistance.



Developed especially for the mountain bike sector, this additional puncture protection layer which completely encircles both tyre beads makes our carcasses robust and impervious against damage and penetration from foreign objects. For maximum effect we combine ProTection with BlackChili Compound. The result: versatile, low weight and an attractive design. In addition, tyres made using this technology can also be used as Tubeless Ready.



With the PolyX Breaker™ we introduce technological know-how from automotive manufacturing to the bicycle tyre sector. Polyester has been used successfully in car tyres for years and has proven its worth. The extremely resilient polyester fibre is woven finely as a cross mesh. This way a high density of fabric is achieved which not only makes our breaker more robust against foreign objects, but also makes it particularly puncture resistant.



Light, fast, safe. Developed together with professional mountain bikers, the RaceSport carcass unites light-weight construction with noticeably improved puncture protection for the perfect competition choice. Light: contains a particularly fine, flexible nylon fabric with an elaborately produced protective rubber coating. Fast and reliable: World Cup quality, low rolling resistance and puncture protection. Combined with our legendary BlackChili Compound, the right combination for XC and Marathon racing. Technology: BlackChili Compound; ultra lightweight construction and 3/180 TPI carcass.

## TECHNOLOGIE MADE IN GERMANY



Continental, der einzige deutsche Fahrradreifenhersteller mit Produktion in Deutschland. "Handmade in Germany" – das heißt, dass die Reifen an unserem Standort Korbach maßgeblich in Handarbeit und mit einem hohen Anteil manueller Arbeitsschritte gefertigt werden. Vom Aufbau der Reifen bis zu ihrer abschließenden Qualitätskontrolle. Für Sie bedeutet das, Ihren Kunden Reifen mit deutscher Technik anbieten zu können – aus Tradition seit 1871. Produkte aus Korbach sind auf den folgenden Seiten mit dem entsprechenden Symbol gekennzeichnet.



Mit unserer einzigartigen, nur in Deutschland hergestellten Laufstreifenmischung haben wir die Radsportszene revolutioniert. Durch das legendäre BlackChili Compound konnten wir die ewige Frage, ob Grip oder Rollwiderstand nachhaltig beantworten. Regelmäßige Testsiege belegen die im Labor und auf der Straße mess- und spürbaren Vorteile für die Fahrer. Neueste Polymere sowie speziell entwickelte Rußpartikel und Füllstoffe garantieren eine einzigartige Performance – ob auf dem Rennrad oder Mountainbike, zum Zeitfahren oder Downhill.



Die Referenz im Pannenschutz – Vectran™ wird aus dem Flüssigkristallpolymer Vectra gesponnen. Dadurch entsteht ein thermoplastisches, mehrfaseriges Garn. Zum Vergleich: Dieses teilkristalline Gewebe ist schnittfester als Aramid und besitzt eine fünfmal höhere Zugfestigkeit als Stahl. Ein Vectran™ Breaker ist leichter, flexibler und schützt effektiver vor Schnitten als vergleichbare Nylon-Breaker. Der Rollwiderstand wird dabei nicht negativ beeinflusst.



Speziell für den Mountainbike-Bereich entwickelt, macht diese zusätzliche, rundum laufende Pannenschutzlage unsere Karkassen besonders widerstandsfähig und unempfindlich gegen Beschädigungen und das Eindringen von Fremdkörpern. Für maximalen Effekt kombinieren wir ProTection mit BlackChili Compound. Das Resultat: vielseitig einsetzbar, geringes Gewicht und ein attraktives Design. Darüber hinaus können Reifen mit dieser Technologie auch Tubeless Ready eingesetzt werden.



Mit dem PolyX Breaker® bringen wir PKW-Know-How ins Fahrradreifensegment: Polyester wird seit Jahren erfolgreich in Autoreifen eingesetzt und hat sich vielfach bewährt. Die extrem widerstandsfähige Polyesterfaser wird engmaschig über Kreuz gewebt. Dadurch wird eine sehr hohe Gewebedichte erreicht, die den Breaker nicht nur widerstandsfähig gegenüber Fremdkörpern, sondern besonders resistent gegen Durchstiche macht. Der Rollwiderstand wird auch durch den PolyX Breaker® nicht negativ beeinflusst.



Leicht, schnell, sicher. Zusammen mit Profi-Mountainbikern entwickelt, vereinen RaceSport-Karkassen konsequenten Leichtbau und gleichzeitig spürbar besseren Pannenschutz auf allerhöchstem Niveau – die perfekte Basis für den Wettkampf. Leicht: enthält ein besonders feines, flexibles Nylongewebe mit aufwendig hergestellter schützender Gummierung. Schnell und sicher: Rollwiderstand und Pannenschutz liegen auf Weltcupniveau zusammen mit unserem legendären BlackChili Compound die richtige Kombination für XC und Marathon Race. Technologie: BlackChili Compound; Extrem leichte Konstruktion und 3/180-TPI-Karkasse.

### Accuracy and passion

- › eleven out of twelve tyres produced in our Korbach plant are handmade
- › the tube is sewn directly onto the carcass with about 400 stitches
- › German technology from the tread compound mixture to completion
- › 100 % quality audit

### Advantages

- › light: lower weight than a clincher tyre
- › fast: high speeds due to reduced rolling resistance
- › fit: can be used with high tyre pressures
- › safe: in the event of a puncture, the tyre will not slide off the rim
- › action: perfect for competition. Ask the pros!

## ACCURACY AND PASSION

Only materials of the highest quality are used for making our tubular tyres. The individual elements are precisely combined and bonded. The most successful cyclists in the world put their faith in our work. Whether on the road or track, tubular tyres made by Continental have made their mark on competitions throughout the world.

**LEIDENSCHAFT UND PRÄZISION.** Für unsere Schlauchreifen kommen ausschließlich die hochwertigsten Materialien zum Einsatz. Die einzelnen Komponenten werden in Maßarbeit zusammengesetzt und miteinander verbunden. Dieser Arbeit vertrauen auch die erfolgreichsten Athleten der Welt. Ob auf der Straße oder auf der Bahn – Schlauchreifen von Continental prägen die Wettkämpfe weltweit.

### Schlauchreifen von Continental

- › elf von zwölf Reifen werden von Hand in unserem Werk in Korbach gefertigt
- › der Schlauch wird mit rund 400 Stichen direkt in die Karkasse eingenäht
- › deutsche Technik von der Mischung bis zur Fertigstellung
- › 100 % Qualitätsprüfung

### Vorteile

- › leicht: geringeres Gewicht als Clincher
- › schnell: hohe Geschwindigkeiten durch reduzierten Rollwiderstand
- › Sitz: auch hohe Reifendrücke fahrbar
- › sicher: im Fall einer Panne springt der Reifen nicht von der Felge
- › im Einsatz: perfekt für den Wettkampf





Our Tubeless Ready [TR] tyres can be used with tubes or sealant. Tyres and rims are designed in such a way that when used together they seal easily. For safety reasons only use wheels designed to be Tubeless Ready. TR tyres have an altogether lighter design. Their sidewalls are less permeable for air and are sealed with a special sealant, for example Conti RevoSealant.



Puncture protection and mileage are the strengths of Hardshell-ProTection. A wider PolyX Breaker™, the specialist against punctures, under the tread centre and shoulders provides for great reliability. The three-ply - each layer with 60 TPI - carcass covers the entire tyre and makes it a real bastion against urban detritus. The outer sidewalls of the tyre are reinforced with DuraSkin® fabric providing even more reliability due to the casing being so well protected. Hardshell tyres are the puncture-resistant flagship amongst racing tyres - produced exclusively in Germany.



Tyres with DuraSkin® sidewall protection can take a beating as they are designed for the most adverse conditions. In rough terrain on a cyclocross or a gravel bike, on commuter bikes where tyres scrape along curbs, on touring bikes as they cross continents encountering many different road qualities and on the race circuit where they prove themselves in endurance events such as the Paris-Roubaix. The high-quality polyamide fabric reliably protects the wall of the tyre. Tyres with DuraSkin® can be identified by the characteristic brown mesh sidewall.

### Quality Hierarchy Premium



#### Premium

- › our premium tyres - made for the highest performance
- › the latest technologies developed with the world's most successful athletes
- › handmade by experienced specialists in Korbach, Germany
- › the best materials for the highest quality and exceptional properties

#### Performance

- › Performance tyres for ambitious racers
- › sound materials and precise workmanship guarantee outstanding quality

#### Sport

- › excellent quality for sports level use



Know-how from motorcycle sport, specially adapted for bicycle racing to address the specific demands of front and rear wheels. Front: agile and direct. The narrower tyre provides reduced air resistance and improved steering characteristics. Rear: comfortable and dampening. With its slightly broader contact surface the tyre provides better traction.

Thanks to the compound mix being optimised for rolling resistance, stiction is reduced. The result: a pioneering front and rear wheel tyre system in which the tyres have been painstakingly matched with one another.



Tubeless Ready Reifen können mit und ohne Schlauch verwendet werden. Um den Reifen ohne Schlauch zu nutzen muss er mit einem speziellen Dichtmittel versiegelt werden. Die revolutionäre Tubeless Ready Wulst ermöglicht eine einfache und unkomplizierte Montage des Reifens. Alle Mountainbike-Reifen von Continental in den Ausführungen ProTection und Performance sind Tubeless Ready. Für optimale Ergebnisse bei der Abdichtung und im Einsatz empfehlen wir die Verwendung des neuen Continental RevoSealant Dichtmittels.



A functional rubber mixture which we utilise for our Performance tyre range. Traction and high mileage are characteristics of tyres made from this compound.



A puncture protection technology made of nylon fibres - protects similar to Kevlar but with low rolling resistance and reduced weight.



Low weight and maximum acceleration distinguishes this technology. Time trial specialists and track racers alike profit from its first-rate rolling characteristics.

## PASSION AND TRADITION

Competing, training camps, racing at the local circuit over the weekend or riding your short lap after work, cycling with a road bike is your passion and with every ride you are living a part of the sport's history. Following our own traditions, we manufacture our products in Korbach with German technology. We have many unique success stories which bear witness to this, such as the Grand Prix 4000 S II tyre.

**LEIDENSCHAFT UND TRADITION.** Im Wettkampf, im Trainingscamp, auf der Hausstrecke am Wochenende oder bei Ihrer kurzen Runde nach Feierabend - Rennradfahren ist Ihre Leidenschaft und mit jeder Ausfahrt leben Sie bewusst ein Stück Sportgeschichte. Im Wissen um unsere eigenen Traditionen fertigen wir unsere Produkte in Korbach mit deutscher Technik. Einzigartige Erfolgsgeschichten wie der Grand Prix 4000 S II zeugen davon.



Eine Pannenschutztechnologie aus Nylonfaser - schützt ähnlich wie Kevlar und dabei mit geringerem Rollwiderstand und wenig Gewicht.



Know-how aus dem Motorradsport, eigens übertragen auf den Rennradsport, um hier den speziellen Anforderungen für Vorder- und Hinterrad gerecht zu werden. Vorn: agil und direkt. Der schmalere Reifen sorgt für einen verringerten Luftwiderstand und ein verbessertes Lenkverhalten. Hinten: komfortabel und dämpfend. Hier mit einer etwas breiteren Aufstandsfläche sorgt der Reifen für verbesserte Traktion. Dank der rollwiderstandsoptimierten Mischung reduziert sich der Abrieb. Das Ergebnis: ein wegweisendes Vorder- und Hinterradreifensystem, bei dem die Reifen ideal aufeinander abgestimmt sind.



Auf Basis des aktivierten Silika Compounds wurde zielstrebig auf eine Mischungstechnologie im Performance-Segment hingearbeitet. Das Ergebnis unserer Korbacher Forschungs- und Entwicklungsabteilung brachte nach intensivem Entwicklungsaufwand eine neue Mischungstechnologie mit hervorragenden Grip- und Langlaufeigenschaften hervor. Die neue Gummimischung mit dem selbsterklärenden Namen „PureGrip“ reiht sich hinter unserem BlackChili Compound ein und wird in Performance-Produkten der Segmente Race und Mountainbike eingesetzt. Hier sorgt es für langanhaltende Traktion und hohe Laufleistung von Continental-Reifen, die exklusiv in der Produktionsstätte in Hefei (Asien) gefertigt werden.



Geringes Gewicht und maximale Beschleunigung zeichnen diese Technologie aus. Zeitfahr- und Bahnspezialisten profitieren von der erstklassigen Rolleigenschaft.



Reifen mit DuraSkin®-Seitenwandschutz müssen ordentlich einstecken können. Sie kommen unter den widrigsten Bedingungen zum Einsatz. Auf Messenger-Bikes rutschen die Reifen an Bordsteinen entlang, auf Reiserädern durchqueren sie Kontinente ohne durchzuscheuern, im Rennsport müssen sie Härteprüfungen wie Paris-Roubaix bestehen. Das hochwertige Polyamid-Gewebe schützt zuverlässig die Flanke des Reifens und wappnet den Reifen für das Äußerste. Aus der breiten Masse heben sich diese Reifen dank ihrer braunen Seitenwand hervor.

### Qualitätsstufen Premium



#### Premium

- › unsere Premium-Reifen - gefertigt, um Höchstleistungen abzurufen
- › neueste Technologien, zusammen entwickelt mit den erfolgreichsten Athleten der Welt
- › in Handarbeit hergestellt von erfahrenen Spezialisten in Korbach [Deutschland]
- › erlesene Materialien für höchste Qualität und herausragende Eigenschaften

#### Performance

- › Performance-Reifen für den ambitionierten Racer
- › solide Materialien und präzise Verarbeitung gewährleisten ausgezeichnete Qualität

#### Sport

- › exzellente Qualität für den sportlichen Einsatz



Überzeugender Pannenschutz und Langlebigkeit sind die Stärken des Hardshell ProTection. Der verbreiterte PolyXBreaker, der Spezialist gegen Platten, schützt sowohl unter der Lauffläche als auch an den Seitenwänden. Zusammen mit der dreilagigen Karkasse mit jeweils 60 TPI pro Lage wird der Reifen so zu einem wahren Bollwerk gegenüber externen Einflüssen. Reifen mit Hardshell ProTection bieten unverwundlichen Schutz - exklusiv handmade in Germany.

### Grand Prix Attack & Force III



**A real racing set that exerts its performance on the road when the hunt for seconds begins**

- > attack the competition: suitable for light weight wheels, highly aerodynamic, low weight
- > outstanding puncture protection with Vectran™, excellent handling characteristics thanks to BlackChili Compound
- > front and rear wheels in different sizes [23/25 mm] are matched to compliment one another

**Ein echtes Racing-Set, das seine Performance auf dem Asphalt dann voll entfaltet, wenn die Jagd auf Sekunden beginnt**

- > Angriff im Wettkampf: geeignet für leichtbau Laufräder, hoch aerodynamisch, geringes Gewicht
- > hervorragender Pannenschutz durch Vectran™, exzellente Fahreigenschaften dank BlackChili Compound
- > Vorder- und Hinterrad sind mit den unterschiedlichen Größen [23/25 mm] aufeinander abgestimmt und ergänzen sich ideal

### Grand Prix 4000 S II



**The leader in our racing range, just as at home on long rides as well as in competitions**

- > all-rounder on rides, whether on the cobblestones of Roubaix or on the mountain road up Mont Ventoux
- > outstanding puncture protection through Vectran™, excellent grip, high mileage and first class rolling thanks to BlackChili Compound
- > a high-performance tyre which regularly stands out in tyre tests

**Die ideale Mischung aus Komfort, Pannenschutz und Leichtlauf**

- > perfekter Allrounder für alle denkbaren Bedingungen
- > hervorragender Pannenschutz durch Vectran™ Pannenschutzeinlage
- > ausgezeichneter Grip, hohe Laufleistung und effizientes Abrollen dank BlackChili Compound

Jan Frodeno  
Winner Ironman Austria 2017



Sebastian Kienle  
Ironman European Champion 2017

### Grand Prix 4-Season



**Our all-year-round tyre and a reliable companion for those high mileage road cyclists.**

- > solid partner for training rides and in competition, come rain or shine
- > outstanding puncture protection, reliable tread with good grip and the highest mileage
- > a tyre with a superior durability ready for any season

**Robuster Ganzjahresreifen mit sorglosem Pannenschutz und souveräner Haltbarkeit.**

- > solider Touren und Trainingsbegleiter der weder Sonne noch Regen scheut
- > hervorragender Pannenschutz durch doppelte Vectran™ Pannenschutzeinlage
- > ausgezeichnete Grip und höchste Laufleistung gepaart mit robustem DuraSkin® Seitenschutz

### Grand Prix Supersonic



**The no compromise tyre purely for competition**

- > simple efficiency, time trial and cycling track specialists profit from its outstanding rolling characteristics
- > light without compromising rolling resistance, but without extra puncture protection, extremely thin treads
- > tyre purely for competitions with reduced mileage

**Beste Rollwiderstand bei geringstem Gewicht**

- > super dünner Laufstreifen, für höchste Effizienz
- > flexible 330 TPI Karkasse, kompromisslos leicht ohne zusätzlichen Pannenschutz
- > ausgezeichneter Grip und effizientes Abrollen dank BlackChili Compound, reiner Wettkampfreifen mit verringerter Laufleistung

model/code	etrt	dimension	color/sidewall	technology	weight g	bar	max. bar	price
<b>Grand Prix Attack &amp; Force III</b>								
0101440	22/24-622	700 x 23/25 C	black/black Skin foldable	Vectran Breaker	370	7,5	8,5	114,90 €
<b>Grand Prix Attack</b>								
0101303	22-622	700 x 22 C	black/black Skin foldable	Vectran Breaker	175	7,5	8,5	69,90 €
<b>Grand Prix Force</b>								
0101304	24-622	700 x 24 C	black/black Skin foldable	Vectran Breaker	195	7,5	8,5	69,90 €
<b>Grand Prix 4000 S II</b>								
0100935	23-571	650 x 23 C	black/black Skin foldable	Vectran Breaker	205	7,5	8,5	59,90 €
0100936	20-622	700 x 20 C	black/black Skin foldable	Vectran Breaker	185	9,0	11,0	59,90 €
0100937	23-622	700 x 23 C	black/black Skin foldable	Vectran Breaker	205	7,5	8,5	59,90 €
0100945	25-622	700 x 25 C	black/black Skin foldable	Vectran Breaker	225	6,5	8,5	59,90 €
0100947	28-622	700 x 28 C	black/black Skin foldable	Vectran Breaker	260	6,5	8,0	59,90 €
<b>Grand Prix 4-Season</b>								
0100173	23-622	700 x 23 C	black/DuraSkin foldable	Double Vectran Breaker	230	7,5	8,5	62,90 €
0100175	25-622	700 x 25 C	black/DuraSkin foldable	Double Vectran Breaker	240	6,5	8,5	62,90 €
0101105	28-622	700 x 28 C	black/DuraSkin foldable	Double Vectran Breaker	280	6,5	8,0	62,90 €
0101095	28-622	701 x 32 C	black/DuraSkin foldable	Double Vectran Breaker	320	6,5	8,0	62,90 €
<b>Grand Prix Supersonic</b>								
0101080	23-622	700 x 23 C	black/black Skin foldable	Supersonic	150	8,0	10,0	54,90 €

### Grand Prix TT



**Time Trials: our specialist for the race against the clock**

- > turns every triathlon and time trial bike into a fighting machine with an ultra-fast semi-slick tread
- > excellent grip and the ability to roll efficiently thanks to BlackChili Compound, reduced puncture protection
- > the tyre for competitions with optimised rolling resistance but limited mileage

**Rollwiderstandsoptimierter Wettkampfreifen mit begrenzter Laufleistung**

- > ultraschnelles Semislick Profil für den Kampf gegen die Uhr
- > hervorragender Pannenschutz durch Vectran™ Pannenschutzeinlage
- > ausgezeichneter Grip und effizientes Abrollen dank BlackChili Compound, reiner Wettkampfreifen mit verringerter Laufleistung

### Grand Prix



**Mountain top finish: a comfortable all-rounder that has been written into cycling history**

- > an all-rounder designed to be tough, made for sporty trips across demanding terrain
- > offers high puncture protection, comfort and good grip
- > with high mileage, available in many sizes

**Bergankunft: ein komfortabler Alleskönner, der Radsportgeschichte geschrieben hat**

- > ein Allrounder mit solidem Aufbau, gemacht für sportliche Ausfahrten in anspruchsvollem Terrain
- > bietet hohen Pannenschutz, Komfort und ordentlich Grip
- > mit besonders hoher Laufleistung und in vielen Größen verfügbar

### Grand Sport Race



**A pure racer and the ideal tyre for competitions and tours**

- > this all-rounder is ready for every challenge, even the biggest ones
- > reliable level of puncture protection thanks to NyTech Breaker insert, high mileage with PureGrip Compound
- > proven Continental racing tyre contour for responsive handling and secure grip

**Technologie von heute im Gewand von gestern**

- > das i-Tüpfelchen für Ihr Retro-Rennrad
- > mit BlackChili Compound und einem starken Breaker technisch auf dem neuesten Stand
- > kommt mit brauner Seitenwand und dem Originalprofil des Conti Sport von 1982
- Offizieller Unterstützer der L'Eroica-Serie 2017/2018

model/code	etrto	dimension	color/sidewall	technology	weight g	bar	max. bar	price
<b>Grand Prix TT</b>								
0100487	23-622	700 x 23 C	black/black Skin foldable	Vectran Breaker	180	7,5	8,5	69,90 €
<b>Grand Prix</b>								
0100506	23-622	700 x 23 C	black/black Skin foldable	PolyX Breaker	225	7,5	8,5	43,90 €
0100637	25-622	700 x 25 C	black/black Skin foldable	PolyX Breaker	245	7,5	8,5	43,90 €
0101109	28-622	700 x 28 C	black/black Skin foldable	PolyX Breaker	275	6,5	8,0	43,90 €
<b>Grand Sport Race</b>								
0150001	23-622	700 x 23 C	black-black Skin foldable	NyTech Breaker	230	7,5	8,5	36,90 €
0150027	25-622	700 x 25 C	black-black Skin foldable	NyTech Breaker	270	6,5	8,5	36,90 €
0150118	28-622	700 x 28 C	black-black Skin foldable	NyTech Breaker	330	5,5	8,0	36,90 €

### Ultra Sport II



**Modern tyre for those new to bicycle racing, available in many sizes and colours**

- > tyres for general road bike riding and competitions with outstanding value for money
- > PureGrip Compound gives lots of grip, very high mileage and efficient rolling characteristics
- > extensive options enable you to get the right tyre for your desired type of riding

**Moderner Einstiegsreifen für den Rennradsport, erhältlich in vielen Dimensionen und Farben**

- > Reifen für Touren und Wettkampf, mit einem hervorragenden Preis-Leistungs-Verhältnis
- > viel Grip, sehr hohe Laufleistung und effizientes Abrollen dank PureGrip Compound
- > umfassende Auswahl für die Feinabstimmung auf den jeweiligen Einsatzzweck



model/code	etrto	dimension	color/sidewall	technology	weight g	bar	max. bar	price
<b>Ultra Sport II</b>								
0150006	23-622	700 x 23 C	black/black Skin	Performance	310	7,5	8,5	20,90 €
0150003	23-622	700 x 23 C	black/black Skin foldable	Performance	240	7,5	8,5	26,90 €
0150009	25-622	700 x 25 C	black/black Skin	Performance	340	6,5	8,5	20,90 €
0150011	25-622	700 x 25 C	black/black Skin foldable	Performance	280	6,5	8,5	26,90 €
0150012	28-622	700 x 28 C	black/black Skin	Performance	410	5,5	8,0	20,90 €
0150014	28-622	700 x 28 C	black/black Skin foldable	Performance	340	5,5	8,0	26,90 €
<b>Ultra Sport II coloured</b>								
0150126	23-622	700 x 23 C	black/red foldable skin	Performance	250	7,5	8,5	26,90 €
0150128	23-622	700 x 23 C	black/orange foldable skin	Performance	250	7,5	8,5	26,90 €
0150129	23-622	700 x 23 C	black/blue foldable skin	Performance	250	7,5	8,5	26,90 €
0150130	23-622	700 x 23 C	black/green foldable skin	Performance	250	7,5	8,5	26,90 €
0150166	25-622	700 x 25 C	black/red foldable skin	Performance	290	6,5	8,5	26,90 €
0150170	25-622	700 x 25 C	black/orange foldable skin	Performance	290	6,5	8,5	26,90 €
0150173	25-622	700 x 25 C	black/blue foldable skin	Performance	290	6,5	8,5	26,90 €
0150174	25-622	700 x 25 C	black/green foldable skin	Performance	290	6,5	8,5	26,90 €
0150169	25-622	700 x 25 C	black/yellow foldable skin	Performance	290	6,5	8,5	26,90 €
0150177	25-622	700 x 25 C	black/pink foldable skin	Performance	290	6,5	8,5	26,90 €





Gatorskin

PolyX Breaker® DuraSkin®

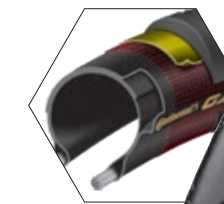

The reptile

- > the market leader amongst road bikers for puncture protection and great service life
- > the reptilian design sets the tone for eating up those miles
- > excellent puncture protection thanks to PolyX Breaker™ puncture protection insert
- > extremely long service life through wear-optimised tread compound

Fahr' doch, wo du willst: weltweit die unangefochtene Nummer eins bei Fixie-Fahrern, Messengern und Urban Bikern

- > der richtige Reifen, wenn es auf der Straße zur Sache geht
- > ordentlich was drauf: der PolyX Breaker™ schützt unter dem Laufstreifen, DuraSkin® macht die Seitenwand undurchlässig
- > die perfekte Wahl, wenn es um knallharte Performance im urbanen Gelände geht



Gator Hardshell

HARD SHELL PROTECTION

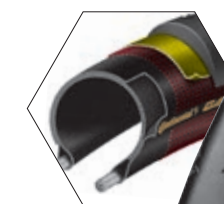

The armoured reptile

- > lends the everyday road rider that certain extra something and gets commuters to work reliably
- > the reptilian design sets the tone for eating up those miles
- > rugged puncture protection through Hardshell ProTecton
- > extremely long service life thanks to wear-optimised tread compound

Asphaltfieber: der pannensichere Dauerläufer für rauere Untergründe, offene Asphaltböden oder am Bordstein

- > gefragter Reifen für Touren und Wettkampf, der auch Pendler sicher zur Arbeit und zurück bringt
- > ausgestattet mit einer besonders harten Gummimischung und einem dicken Laufstreifen, die rundum laufende Hardshell-Lage schützt umfassend vor äußeren Einflüssen
- > ideal, wenn eine hohe Kilometerleistung und Langlebigkeit gefragt sind

model/code	etrto	dimension	color/sidewall	technology	weight g	bar	max. bar	price
<b>Gatorskin</b>								
0118538	23-622	700 x 23C	black/DuraSkin foldable	Race Quality	220	7,5	8,5	49,90 €
0100084	25-622	700 x 25C	black/DuraSkin foldable	Race Quality	240	6,5	8,5	49,90 €
0100641	28-622	700 x 28C	black/DuraSkin foldable	Race Quality	300	5,5	8,0	49,90 €
0100642	32-622	700 x 32C	black/DuraSkin foldable	Race Quality	350	6,0	7,0	49,90 €
<b>Gator Hardshell</b>								
0100311	23-622	700 x 23C	black/DuraSkin foldable Hardshell	Race Quality	250	7,5	8,5	62,90 €
0100313	25-622	700 x 25C	black/DuraSkin foldable Hardshell	Race Quality	270	6,5	8,5	62,90 €
0100639	28-622	700 x 28C	black/DuraSkin foldable Hardshell	Race Quality	375	5,5	8,0	62,90 €
0100640	32-622	700 x 32C	black/DuraSkin foldable Hardshell	Race Quality	375	6,0	7,0	62,90 €

### GP Attack & Force Tubular Comp



**The aerodynamic racing tubular set developed by professional racers**

- > light and fast, developed especially for the demanding requirements of hard, fast racing action
- > outstanding puncture protection through Vectran™, excellent handling characteristics thanks to BlackChili Compound
- > perfection with its high performance, combining low rolling resistance, high agility and comfort

**Tuning Rennset für agiles Handling und gripstarken Vortrieb**

- > aerodynamisches und agiles Vorderrad gepaart mit gripstarkem und komfortablem Hinterrad
- > hervorragender Pannenschutz durch Vectran™ Pannenschutzeinlage
- > ausgezeichneter Grip, hohe Laufleistung und effizientes Abrollen dank BlackChili Compound



### Competition



**It's time to race the classic for competition - not just for professionals**

- > robust all-rounder appearing at the sharp end in all the major cycle races around the world
- > a high-performance tread compound coupled with reliable puncture protection
- > agile and fast, adapts to the competition in all road conditions

**Die ideale Mischung aus Komfort, Pannenschutz und Leichtlauf**

- > perfekter Allrounder mit ProTour bewährtem Aufbau
- > hervorragender Pannenschutz durch Vectran™ Pannenschutzeinlage
- > ausgezeichneter Grip, hohe Laufleistung und effizientes Abrollen dank BlackChili Compound



### GP 4000 S II Tubular



**Our legendary clincher, available as tubular tyre: seamless manufacturing design with grip - speed and great handling as an enduring all-rounder**

- > this all-rounder tubular tyre is particularly suited for those longer rides
- > it has outstanding puncture protection and a rubber compound which ensures good grip
- > special carcass design ensures a perfect fit on the rim

**Die ideale Mischung aus Komfort, Pannenschutz und Leichtlauf**

- > perfekter Allrounder für alle denkbaren Bedingungen
- > hervorragender Pannenschutz durch Vectran™ Pannenschutzeinlage
- > ausgezeichneter Grip, hohe Laufleistung und effizientes Abrollen dank BlackChili Compound



### Sprinter



**If the aim is winning points then this nimble Sprinter is the right tyre for you**

- > efficient tyres for criteriums or triathlon where the tyres' characteristics will shine through
- > proven puncture protection through the SafetySystem Breaker
- > neutral slick profile for a direct feel with the road. Full speed ahead!

**Der effiziente Wettkampfreifen, der bei Kriterien und Triathlons seine Stärken auspielt**

- > neutrales Slickprofil für direktes Straßenfeeling und pfeilschnelles Vorankommen
- > bewährter Pannenschutz durch SafetySystem Pannenschutzeinlage
- > ausgezeichneter Grip, hohe Laufleistung und effizientes Abrollen dank BlackChili Compound



### Sprinter Gatorskin



**The sprinter in the group, designed for extended rides and training**

- > the roads of Flanders, Roubaix and San Remo are home to this tough tubular
- > durable and puncture protected carcass, ready for hundreds of kilometres even on bad roads
- > big volume ensures additional grip and improved rolling characteristics

**Langlebige und pannensichere Karkasse, gewappnet für unzählige Kilometer**

- > solider Touren und Trainingsbegleiter der auch schlechtesten Straßenbedingungen trotzt
- > bewährter Pannenschutz durch SafetySystem Pannenschutzeinlage
- > ausgesprochen lange Lebensdauer durch abrieboptimierte Laufstreifenmischung



Ag2r La Mondiale Pro Cycling Team



**Safety System**

Puncture and cut-proof, but still light and flexible, the tyre adapts better to the terrain. Provides particularly comfortable handling characteristics.

**Safety System**

Stich- und schnittfest, dabei besonders leicht und flexibel passt sich der Reifen dem Untergrund besser an. Bietet besonders komfortable Fahreigenschaften.

model/code	etrto	dimension	color/sidewall	technology	weight g	bar	max. bar	price
<b>Set GP Attack &amp; Force Tubular</b>								
0100748		28" x 22/24 mm	black/black Skin	Vectran Breaker	500	8,0	12,0	219,90 €
<b>GP Attack Tubular</b>								
0196231		28" x 22 mm	black/black Skin	Vectran Breaker	240	8,0	12,0	114,90 €
<b>GP Force Tubular</b>								
0196232		28" x 24 mm	black/black Skin	Vectran Breaker	260	8,0	12,0	114,90 €
<b>Competition</b>								
0196141		26" x 22 mm	black/black Skin	Vectran Breaker	250	8,0	12,0	114,90 €
0196140		28" x 19 mm	black/black Skin	Vectran Breaker	230	10,0	12,0	114,90 €
0196138		28" x 22 mm	black/black Skin	Vectran Breaker	260	8,0	12,0	114,90 €
0196189		28" x 25 mm	black/black Skin	Vectran Breaker	280	8,0	12,0	114,90 €
<b>GP 4000 S II Tubular</b>								
0196241		28" x 22 mm	black/black Skin	Vectran Breaker	270	8,0	12,0	119,90 €
<b>Sprinter</b>								
0196135		28" x 22 mm	black/black Skin	SafetySystem Breaker	275	8,0	12,0	65,90 €
0196244		28" x 25 mm	black/black Skin	SafetySystem Breaker	295	8,0	12,0	65,90 €
<b>Sprinter Gatorskin</b>								
0196136		28" x 22 mm	black/black Skin	SafetySystem Breaker	280	8,0	12,0	70,90 €
0196187		28" x 25 mm	black/black Skin	SafetySystem Breaker	300	8,0	12,0	70,90 €

### Podium TT



- Time Trials: for maximum acceleration in the race against the clock**
- > high level competition tub, using an ultra-fast mini diamond profile, perfect for triathlon and time trial specialists
  - > providing puncture protection at a low weight
  - > optimised for speed but with limited mileage
- Rollwiderstandsoptimierter Wettkampfreifen mit begrenzter Laufleistung**
- > ultraschnelles Minidiamant Profil für den Kampf gegen die Uhr
  - > hervorragender Pannenschutz durch Vectran™ Pannenschutzeinlage
  - > ausgezeichneter Grip und bester Rollwiderstand dank BlackChili Compound

### Giro



- For newcomers: the perfect companion for training and leisure rides**
- > a reliable all-round tyre, high quality for newcomers with high aspirations
  - > outstanding rolling characteristics and robust qualities that will make them last for many miles
  - > high mileage and excellent value for money
- Der perfekte Allround-Reifen in bekannter Continental Qualität**
- > bewährte Continental Rennreifenkontur für agiles Handling und sicheren Grip
  - > hervorragender Pannenschutz durch hochwertige zweilagige 80TPI Karkasse
  - > ausgesprochen lange Lebensdauer durch abrieboptimierte Laufstreifenmischung



model/code	etrto	dimension	color/sidewall	technology	weight g	bar	max. bar	price
<b>Podium TT</b>								
0196180		28" x 22 mm	black/black Skin	Vectran Breaker	225	11,0	12,0	119,90 €
0196243		28" x 25 mm	black/black Skin	Vectran Breaker	245	8,0	12,0	119,90 €
<b>Giro</b>								
0196017		28" x 22 mm	black/transparent Skin	Performance	300	8,0	10,0	34,90 €





Patrick Seabase  
Freecycler

### Race King CX



#### Our flow guarantee for challenging offroad riding

- > outstanding for use on smoother terrain such as forest tracks and hillside paths
- > technically manufactured with an optimal ratio of grip, ability to adapt to the terrain and low rolling resistance
- > breathtaking rides guaranteed!

#### Unser Flow-Garant für anspruchsvolle Fahrten im Gelände

- > hervorragend für den Einsatz auf festem Untergrund, wie Wald- und Feldwege
- > technisch mit optimalem Verhältnis aus Grip, Boden Anpassung und niedrigem Rollwiderstand gefertigt
- > atemberaubende Ausfahrten garantiert

### Speed King CX



#### A lust for speed, the faster it goes the better it performs

- > a tyre designed for racing over solid, dry or frozen terrain
- > a fast, scaly central tread design which also ensures a high level of puncture protection
- > suitable for the heat of competition and as a commuter/tourer
- > a carcass width of 32 mm complies with UCI rules

#### Ein Tuningreifen, der durch mehr Vortrieb andere Seiten aufzieht

- > renntauglicher Reifen für festen, trockenen oder gefrorenen Untergrund
- > mit schneller schuppenförmiger Mittellauffläche, die on top für extra Pannenschutz sorgt
- > für den Einsatz auf der Tour und im Wettkampf geeignet
- > die Karkasse mit 32 mm erfüllt das UCI-Reglement

### CycloXKing



#### The expert for touring and competition - at home on any terrain

- > a high performing all-rounder suitable for different terrain
- > smooth running and fast rolling from the evenly distributed central tread, a lot of grip in turns from the pronounced outer lugs
- > a carcass width of 32 mm complies with UCI rules

#### Der Experte für Tour und Wettkampf - auf jedem Terrain zu Hause

- > ein leistungsstarker Alleskönner, der sich auch auf den verschiedensten Untergründen zurechtfindet
- > laufruhiges und schnelles Profil durch gleichmäßige Mittelstollen, viel Kurvengrip durch überhöhte Außenstollen
- > die Karkasse mit 32 mm erfüllt das UCI-Reglement

model/code	etrto	dimension	color/sidewall	technology	weight g	bar	max. bar	price
<b>Race King CX</b>								
0150280	35-622	700 x 35 C	black/black Skin foldable	Sport	350	4,0	6,0	36,90 €
<b>Speed King CX</b>								
0150279	35-622	700 x 35 C	black/black Skin foldable	Sport	350	4,0	6,0	36,90 €
<b>CycloXKing</b>								
0150281	35-622	700 x 35 C	black/black Skin foldable	Sport	380	4,0	6,0	36,90 €

## PASSION AND FLOW

Biking without limits, savouring the trail and looking back on the ride with a beaming smile. For your perfect mountain biking experience, our tyres are continuously being developed. To achieve this we trust in only the most reliable materials and technologies. Perfect grip on any surface is our goal every time.

### LEIDENSCHAFT UND FLOW

Grenzenlos Biken, den Trail voll auskosten und hinterher zufrieden auf die Tour zurückschauen. Für das perfekte Fahrgefühl auf Ihrem Mountainbike entwickeln wir unsere Reifen kontinuierlich weiter. Hierfür setzen wir nur auf die zuverlässigsten Materialien und Technologien. Perfekter Grip auf jedem Untergrund ist uns gerade gut genug.



# TECHNOLOGIES MOUNTAIN BIKE

All new Mountainbike ProTectonApex and ProTecton tyres have been tested and approved for an extreme hubload of 95 kg [for 2.2 tyres] to 105 kg. Thus, they easily satisfy modern e-MTB requirements.

## TECHNOLOGIEN MOUNTAINBIKE

Alle neuen Mountainbike-ProTectonApex- und -Protection-Reifen sind mit sehr hohen Achslasten von 95 [2.2] bis 105 kg getestet und freigegeben worden. Somit stecken sie locker die Ansprüche moderner e-MTBs weg.

### ProTectonApex

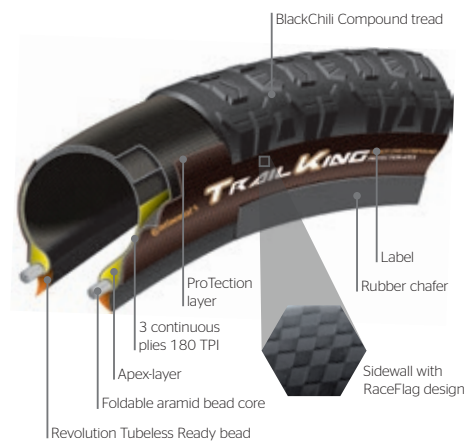

#### Challenges need to be mastered.

The ProTecton layer prevents cuts and punctures without any significant increase in weight. An extra Apex sidewall protects the tyre from impact punctures even at low pressures. BlackChili Compound gives added grip and for optimising weight, the tyre can be set up tubeless with Conti RevoSealant. Technology: BlackChili Compound; 3/180 TPI carcass; 50 x 40 TPI ProTecton weave; 13 mm Apex sidewall reinforcement

#### Schnelle, harte Abfahrten und kräfteaubende Anstiege.

Die ProTecton-Lage arbeitet sicher gegen Schnitte und Durchstiche, ohne das Gewicht übermäßig zu erhöhen. Eine zusätzliche Apex-Seitenwandstabilisierung schützt den Reifen auch bei geringem Reifendruck sicher vor Durchschlägen. BlackChili Compound macht den Reifen griffig und zur Gewichtsoptimierung besteht die Möglichkeit, den Reifen zusammen mit Conti RevoSealant Tubeless Ready zu fahren. Technologie: BlackChili Compound; 3/180-TPI-Karkasse; 50 x 40 TPI-ProTecton-Gewebe; 13 mm Apex-Seitenwandverstärkung.

### ProTecton

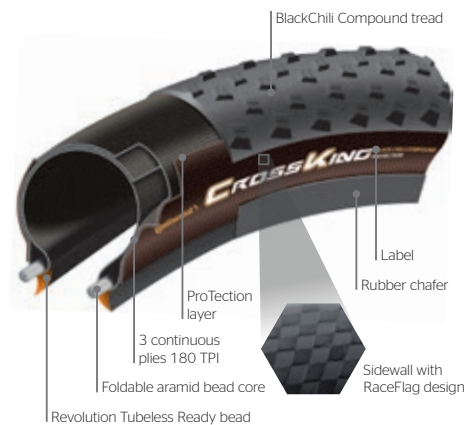

#### The hard way.

The ProTecton technology gives our tyres their perfect mix of fast rolling, grip and puncture protection. Four plies under the tread and three in the sidewalls make this possible. The whole tyre attains greater resilience and becomes less vulnerable to damage. Adheres well to the terrain, even on the toughest trails. BlackChili Compound ensures smooth rolling and the required grip. The revolutionary Tubeless Ready base enables the tyre to be mounted easily. Conti RevoSealant gives reliable sealing. Technology: BlackChili Compound; 3/180 TPI carcass; 50 x 40 TPI ProTecton weave.

#### Auf die harte Tour.

Die ProTecton-Technologie verleiht unseren Reifen ihre perfekte Mischung aus Leichtlauf, Grip und Pannenschutz. Bügelt sauber, selbst über die härtesten Trails. BlackChili Compound sorgt für den nötigen Leichtlauf und Grip. Der revolutionäre Tubeless-Ready-Fuß ermöglicht eine leichte und unkomplizierte Montage des Reifens. Conti Revo-Sealant dichtet zuverlässig ab. Technologie: BlackChili Compound; 3/180-TPI-Karkasse; 50 x 40 TPI-ProTecton-Gewebe.

### Apex



Successfully used in car tires for years, its transition for use in our bicycle tires was only a matter of time. Apex stabilises the tire in turns and is a technology that also makes sense for high-volume bicycle tires. A natural rubber profile, set between the carcass layers at the base of the tire. Improved stiffens of the sidewalls by minimising the twisting of the tire by the high transverse loads. Stiffer sidewalls that in turn, reduce the risk of punctures and impede the tire from slipping off the rim. It is destined for Downhill, Gravity Enduro and Freeride. Low pressure, enhanced grip is made possible without becoming too slack in corners. The risk of punctures decreases significantly.

Seit Jahren in Pkw-Reifen erfolgreich eingesetzt, stabilisiert der Apex den Reifen in Kurven. Eine Technologie, die auch bei großvolumigen Fahrradreifen sinnvoll ist. Der Apex ist ein Kautschuk-Profil, welches zwischen die Karkasslagen auf den Fuß des Reifens gesetzt wird. Er versteift die Seitenflanken des Reifens und minimiert dadurch die Verwindung des Reifens bei hohen Querbelastungen. Darüber hinaus reduzieren die versteiften Seitenflanken das Risiko eines Durchschlagschadens und verhindern, dass der Reifen von der Felge rutscht. Diese Eigenschaften prädestinieren den Apex für unsere Downhill- und Freeride-Reifen: Der Betriebsdruck kann zugunsten des Grips weiter reduziert werden, ohne dabei ein schwammiges Kurvenverhalten oder ein erhöhtes Durchschlagsrisiko in Kauf nehmen zu müssen.

### RaceSport

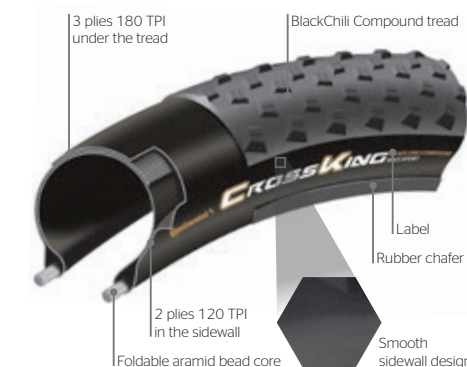

#### Light, fast, safe.

Developed together with professional mountain bikers, the RaceSport carcass unites light-weight construction with noticeably improved puncture protection for the perfect competition choice. Light: contains a particularly fine, flexible nylon fabric with an elaborately produced protective rubber coating. Fast and reliable: World Cup quality, low rolling resistance and puncture protection. Combined with our legendary BlackChili Compound, the right combination for XC and Marathon racing. Technology: BlackChili Compound; ultra lightweight construction and 3/180 TPI carcass.

#### Leicht, schnell, sicher.

Zusammen mit Profi-Mountainbikern entwickelt, vereinen RaceSport-Karkassen konsequenten Leichtbau und gleichzeitig spürbar besseren Pannenschutz auf allerhöchstem Niveau - die perfekte Basis für den Wettkampf. Leicht: enthält ein besonders feines, flexibles Nylongewebe mit aufwendig hergestellter schützender Gummierung. Schnell und sicher: Rollwiderstand und Pannenschutz liegen auf Weltcupniveau zusammen mit unserem legendären BlackChili Compound die richtige Kombination für XC und Marathon Race. Technologie: BlackChili Compound; Extrem leichte Konstruktion und 3/180-TPI-Karkasse.

### Performance

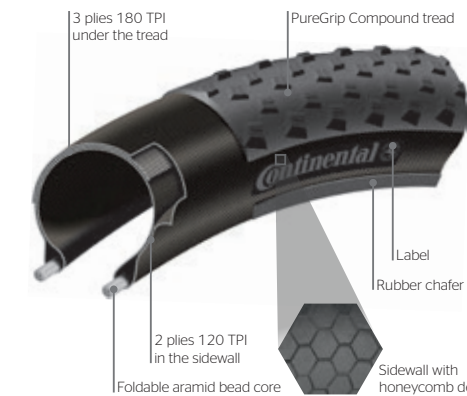

#### Reliable quality.

PureGrip is the compound technology which we use exclusively for our Performance level series. The name speaks for itself - the combination of superior grip and longevity. A long lasting rubber mixture with a robust 60-TPI-Nylon carcass guarantees the highest durability. Tubeless Ready: reliable sealing with Conti RevoSealant. A strong aramide foldable bead ensures a secure fit to the rim. For ambitious hobby cyclists, a low-cost alternative to our Premium line. Technology: PureGrip Compound; Tubeless Ready; revolutionary Tubeless Ready base; robust and full sidewall rubber coating; 3/180 TPI carcass and sidewall with wafer design pattern.

#### Zuverlässige Qualität.

PureGrip ist die Mischungstechnologie, die wir exklusiv für unsere Performance-Qualitätsreihe verwenden. Der Name spricht für sich - die Kombination Grip und Langlebigkeit ist Programm. Die langlebige und haftungsstarke Gummimischung verspricht langes Fahrvergnügen eine robuste 60-TPI-Nylon-Karkasse gewährleistet beste Haltbarkeit. Tubeless Ready: zuverlässiges Abdichten mit Conti RevoSealant möglich. Ein starker Aramidfaltkern sorgt für festen Halt auf der Felge. Für ambitionierte Hobbysportler eine preiswerte Alternative zu unserer Premium-Linie. Technologie: PureGrip; Tubeless Ready; Revolution-Tubeless-Ready-Fuß; robuste und satte Seitenwandgummierung; 3/180-TPI-Karkasse; Seitenwand im Flag-Design.

### Der Baron 2.4 Projekt



More comfort,  
more volume!



### Cross King 2.4

### B+Tyres

B+ tyres offer an especially comfortable riding experience. By virtue of their large volume, the tyres roll over obstacles easily, showing more traction and hugging the trail instead of just rolling over it. These tyres' weight is comparatively low. Their optimised carcasses allow for lower tyre pressure and thus offer the special grip experience.



### Trail King 2.4



### Mountain King 2.4

### B+Tyres

B+-Reifen bieten ein besonders komfortables Fahrverhalten. Durch den größeren Durchmesser rollt der Reifen leichter über die Hindernisse, zeigt mehr Traktion und schmiegt sich so dem Trail an, statt bloß darüber hinwegzurollen. Das Gewicht dieser Reifen bleibt verhältnismäßig niedrig. Durch ihre speziell optimierte Karkasse ist es möglich, B+-Reifen mit geringerem Luftdruck als gewohnt zu fahren. Somit bieten B+-Reifen das besondere Grip-Erlebnis.

### Der Kaiser 2.4



**Sometimes a king also wants to put his racing hat on**

- > an uncompromising racing tyre which we have developed together with the best athletes world wide
- > low rolling resistance, high puncture protection, grip in every turn
- > runs: train on the Kaiser 2.5 then race with the Kaiser 2.4 Projekt
- > tyre with reduced durability for competitions

**Race-Reifen mit effizientem Vortrieb, phänomenaler Bremspower und präzisiertem Kurvenverhalten**

- > Profildesign, direkt von den härtesten Weltcupstrecken abgeleitet
- > hervorragender Pannenschutz mit durchgehend doppellagiger Apex Konstruktion
- > ausgezeichneter Grip und effizientes Abrollen dank BlackChili Compound, reiner Wettkampfreifen mit verringerter Laufleistung

### Der Baron 2.4



**Respect where it is due: the undisputed master in Enduro**

- > technical, versatile, fastidious and developed together with the best athletes world wide
- > highly durable, puncture protected and good rolling resistance combined with a favourable weight
- > family ties: With its widely spaced tread lugs it shares its genetic suitability for mud. The Mud King sends its respects

**Technisch vielseitiger und anspruchsvoller Enduroreifen, der immer die richtige Wahl ist**

- > vielseitiges Profildesign mit guten Rolleigenschaften bei sportlichem Gewicht
- > hervorragender Pannenschutz und höchste Stabilität dank ProTecton TubelessReady Lage und Apex-Versteifung
- > ausgezeichneter Grip, hohe Laufleistung und effizientes Abrollen dank BlackChili Compound

Andreu Lacondeguy



model/code	predecessor	etrto	dimension	color/sidewall	technology	weight g	bar	max. bar	price
<b>Der Kaiser 2.4 Projekt</b>									
0101567	0101114	60-584	27.5 x 2.4	black/black foldable	ProTecton Apex	950	2.5	3.5	70,90 €
0101569		60-622	29 x 2.4	black/black foldable	ProTecton Apex	1.000	2.5	3.5	70,90 €
<b>Der Baron 2.4 Projekt</b>									
0101572		60-584	27.5 x 2.4	black/black Skin foldable	ProTecton Apex	950	2.5	3.5	70,90 €
0101573		60-622	29 x 2.4	black/black Skin foldable	ProTecton Apex	1.000	2.5	3.5	70,90 €

### Mud King



**The name speaks for itself: born in the mud, at home in the mud**

- > the right choice for fast Race Hardtails [1.8] and Downhill Bikes [2.3]
- > the narrow carcass ensures a sufficient gap between tyre and the frame so that mud does not accumulate
- > with the best braking and handling characteristics, it is sure footed even under the most difficult conditions

**Reifen für tiefe und matschige Verhältnisse mit schmaler Karkasse für ausreichende Rahmenfreiheit**

- > grobstolliges Profil für optimale Brems- und Lenkkraftübertragung, auch bei schwierigsten Bedingungen
- > hervorragender Pannenschutz mit durchgehender ProTecton TubelessReady Lage von Fuß zu Fuß
- > ausgezeichneter Grip, hohe Laufleistung und effizientes Abrollen dank BlackChili Compound

### Trail King



**Climbing artist: strong performer on the most difficult trails**

- > endless biking on Enduro and All Mountain Bikes
- > many small lugs guarantee superior traction, the carcass offers superior resistance against punctures
- > the rider receives constant feedback from the tyres enabling them to adapt to the conditions and maintain a good flow

**Kletterkünstler: saubere Performance auf den schwierigsten Trails**

- > grenzenloses Biken auf Enduro- und All-Mountain-Rädern
- > viele kleine Stollen garantieren beste Traktion, die Karkasse bietet viel Stauraum gegen Durchschläge
- > der Fahrer erhält ständig Feedback vom Reifen, kann sich so auf die Bedingungen einstellen und bleibt im Flow

model/code	predecessor	etrto	dimension	color/sidewall	technology	weight g	bar	max. bar	price
<b>Mud King 1.8 ProTecton</b>									
0101084		47-584	27.5 x 1.8	black/black Skin foldable	ProTecton	550	3.0	4.5	59,90 €
0100918		47-622	29 x 1.8	black/black Skin foldable	ProTecton	580	3.0	4.5	59,90 €
<b>Der Mud King 2.3</b>									
0100414		57-559	26 x 2.3	black/black	Apex	1100	3.0	4.5	81,90 €
0101083		57-622	29 x 2.3	black/black	Apex	1160	3.0	4.5	81,90 €
<b>Trail King 2.2 ProTecton</b>									
0101468	0101117	55-584	27.5 x 2.2	black/black Skin foldable	ProTecton Apex	855	3.0	4.0	70,90 €
0101476	0101118	55-622	29 x 2.2	black/black Skin foldable	ProTecton Apex	920	3.0	4.0	70,90 €
<b>Trail King 2.2 Performance</b>									
0150293	050107	55-584	27.5 x 2.2	black/black Skin foldable	Performance	762	3.0	4.0	32,90 €
0150298		55-622	29 x 2.2	black/black Skin foldable	Performance	813	3.0	4.0	32,90 €
<b>Trail King 2.4 ProTecton</b>									
0101478	0100653	60-559	26 x 2.4	black/black foldable	ProTecton Apex	825	2.5	3.5	70,90 €
0101460	0100903	60-584	27.5 x 2.4	black/black foldable	ProTecton Apex	890	2.5	3.5	70,90 €
0101477	0100656	60-622	29 x 2.4	black/black foldable	ProTecton Apex	945	2.5	3.5	70,90 €
<b>Trail King 2.4 Performance</b>									
0150288	0150106	60-584	27.5 x 2.4	black/black Skin foldable	Performance	885	3.0	4.0	32,90 €
0150299	0150140	60-622	29 x 2.4	black/black Skin foldable	Performance	943	3.0	4.0	32,90 €
0150234		60-584	27.5 x 2.4	black/black Skin	Performance	890	3.0	4.0	25,90 €
<b>Trail King 2.6 ProTecton</b>									
0101382		65-584	27.5 x 2.6	black/black foldable	ProTecton Apex	930	2.0	3.0	79,90 €



### Mountain King



updated profile  
re-engineered sidewall

#### Hero on the mountain: the perfect trail companion

- > sure riding in hilly terrain and also optimal for the touring mountain bike
- > superior grip from its continuous central tread and its grippy outer lugs
- > the perfect companion for exploring the trails

#### Held am Berg: perfekter Tourenbegleiter mit Bodenhaftung

- > sicher im bergigen Gelände unterwegs und ebenso optimal auf dem Touren-Mountainbike
- > viel Grip durch seine bissigen Mittel- und griffigen Außenstollen
- > als All-Mountain-Reifen mit Enduro-Ambitionen der perfekte Begleiter für sportliche Ausfahrten

### Cross King



updated profile  
re-engineered sidewall

#### A first class all-rounder which also proves itself in competitions

- > versatile competition and trail tyre, sure footed in turns and comfortable
- > good grip and available with various technologies
- > smoothly rolling tyre that adapts to any terrain with its special tread

#### Ein erstklassiger Allrounder, der sich auch gern mal im Wettkampf beweist

- > vielseitiger Wettkampf- und Tourenreifen mit sicherem Kurvenhalt und Fahrkomfort
- > guter Grip und leises Abrollverhalten, mit verschiedenen Technologien verfügbar
- > leichtläufiger Reifen, der sich mit seinem speziellen Profil jedem Untergrund anpasst

### Race King



updated profile  
re-engineered sidewall

#### For the skilled: a hearty tyre that wants to be raced

- > impressive in cross-country races and marathons, for hardtails and full suspension race bikes
- > low rolling resistance, a voluminous carcass and exemplary self-dampening qualities
- > minimal tread: for dedicated cyclists, for those who have the hunger for speed

#### Für Könnler: ein kerniger Wettkampftyp, der sich bei Rennen messen will

- > überzeugend bei Cross-Country-Rennen und im Marathon, für Hardtails und Race Fulls
- > kommt mit geringem Rollwiderstand, einer voluminösen Karkasse und sehr guter Eigendämpfung daher
- > wenig Profil: beste Voraussetzungen für Vielfahrer, die es drauf haben

model/code	predecessor	etrto	dimension	color/sidewall	technology	weight g	bar	max. bar	price
<b>Mountain King II 2.2</b>									
0150246	0100851	55-584	27.5 x 2.2	black/black Skin	Sport	750	3,5	4,5	25,90 €
<b>Mountain King II 2.3 ProTction</b>									
0101461	0100907		27.5 x 2.3	black/black Skin foldable	ProTction	705	2,5	3,5	62,90 €
0101469	0100723		29 x 2.3	black/black Skin foldable	ProTction	745	2,5	3,5	62,90 €
<b>Mountain King III 2.3 Performance</b>									
0150301		58-559	26 x 2.3	black/black Skin foldable	Performance	762	3,5	4,5	32,90 €
0150289	0150111	58-584	27.5 x 2.3	black/black Skin foldable	Performance	796	3,5	4,5	32,90 €
0150294	0150048	58-622	29 x 2.3	black/black Skin foldable	Performance	845	3,5	4,5	32,90 €
<b>Mountain King 2.6</b>									
0101583		65-584	27.5 x 2.6	black/black foldable	ProTction	815	2,0	3,0	79,90 €
<b>Cross-King 2.2 ProTction</b>									
0101483	0100524		26 x 2.2	black/black Skin foldable	ProTction	570	3,0	4,0	62,90 €
0101465	0100910		27.5 x 2.2	black/black Skin foldable	ProTction	600	3,0	4,0	62,90 €
0101471	0100532		29 x 2.2	black/black Skin foldable	ProTction	640	3,0	4,0	62,90 €
<b>Cross King II 2.2 Performance</b>									
0150303	0150002	55-559	26 x 2.2	black/black Skin foldable	Performance	711	3,5	4,5	32,90 €
0150291		55-584	27.5 x 2.2	black/black Skin foldable	Performance	743	3,5	4,5	32,90 €
0150295	0150045	55-622	29 x 2.2	black/black Skin foldable	Performance	793	3,5	4,5	32,90 €
<b>Cross King 2.2 RaceSport</b>									
0101464	0100911		27.5 x 2.2	black/black Skin foldable	RaceSport	530	3,0	4,0	59,90 €
0101470	0100531		29 x 2.2	black/black Skin foldable	RaceSport	565	3,0	4,0	59,90 €
<b>Cross King 2.3 RaceSport</b>									
0101462	0100899		27.5 x 2.3	black/black Skin foldable	RaceSport	635	2,5	3,5	59,90 €
0101474	0100726		29 x 2.3	black/black Skin foldable	RaceSport	675	2,5	3,5	59,90 €
<b>Cross King 2.3 ProTction</b>									
0101463	0100909		27.5 x 2.3	black/black Skin foldable	ProTction	705	2,5	3,5	62,90 €
0101475	0100725		29 x 2.3	black/black Skin foldable	ProTction	745	2,5	3,5	62,90 €
<b>Cross King II 2.3 Performance</b>									
0150302		58-559	26 x 2.3	black/black Skin foldable	Performance	749	3,5	4,5	32,90 €
0150290	0150110	58-584	27.5 x 2.3	black/black Skin foldable	Performance	782	3,5	4,5	32,90 €
0150297	0150042	58-622	29 x 2.3	black/black Skin foldable	Performance	831	3,5	4,5	32,90 €
<b>Cross-King 2.6 ProTction</b>									
0101384		65-584	27.5 x 2.6	black/black foldable	ProTction	815	2,0	3,0	79,90 €
<b>Race King II 2.0</b>									
0150309	0150109	50-584	26 x 2.3	black/black Skin foldable	Performance	615	3,5	4,5	32,90 €
0150307	0150035	50-622	27.5 x 2.3	black/black Skin foldable	Performance	655	3,5	4,5	32,90 €
0150160	0100271	50-622	29 x 2.3	black/black Skin foldable	Performance	680	3,5	4,5	25,90 €
<b>Race King 2.2 RaceSport</b>									
0101466	0100914		27.5 x 2.2	black/black Skin foldable	RaceSport	500	3,0	4,0	59,90 €
0101472	0100545		29 x 2.2	black/black Skin foldable	RaceSport	530	3,0	4,0	59,90 €
<b>Race King 2.2 ProTction</b>									
0101486	0100540		26 x 2.2	black/black Skin foldable	ProTction	545	3,0	4,0	62,90 €
0101467	0100913		27.5 x 2.2	black/black Skin foldable	ProTction	570	3,0	4,0	62,90 €
0101473	0100546		29 x 2.2	black/black Skin foldable	ProTction	605	3,0	4,0	62,90 €
<b>Race King 2.2 Performance</b>									
0150152			26 x 2.2	black/black Skin	Performance	670	3,5	4,5	25,90 €
0150304	0150033	55-559	26 x 2.2	black/black Skin foldable	Performance	669	3,5	4,5	32,90 €
0150292	0150092	55-584	27.5 x 2.2	black/black Skin foldable	Performance	699	3,5	4,5	32,90 €
0150296	0150036	55-622	29 x 2.2	black/black Skin foldable	Performance	748	3,5	4,5	32,90 €

### Speed King



**A lust for speed, the faster it goes the better it performs**

- > a tyre designed for racing over solid, dry or frozen terrain
- > a fast, scaly central tread design which also ensures a high level of puncture protection
- > suitable for the heat of competition and as a commuter/tourer
- > a carcass width of 32 mm complies with UCI rules

**Tuningreifen für Rennmaschinen und Carbon-Hardtails mit Minimalgewicht**

- > vortriebsorientierte Profilgeometrie mit geringstem Rollwiderstand die nach einer geschulten Hand verlangt
- > kompromisslos schnelle und Weltcup erprobte RaceSport Karkasse
- > ausgezeichneter Grip und effizientes Abrollen dank BlackChili Compound, reiner Wettkampfreifen mit verringerter Laufleistung

### Traffic



**Reliable riding in the urban jungle**

- > specially developed for daily use of the MTB in town and in the countryside
- > a specific central tread design for quiet and fast rolling on the road
- > thanks to a tough design and robust sidewalls it is a fearless companion in traffic

**Sicher biken im Großstadtdschungel**

- > speziell entwickelt für den täglichen MTB-Einsatz in der Stadt und auf dem Land
- > ruhiger und schneller Lauf auf der Straße durch das besondere Mittelstegprofil
- > dank massiver Bauweise und robuster Seitenwand ein unerschrockener Begleiter im Straßenverkehr



model/code	etrto	dimension	color/sidewall	technology	weight g	bar	max. bar	price
<b>Speed King 2.2 RS</b>								
0100933	55-622	29 x 2.2	black/black Skin foldable	RaceSport	465	3,5	4,5	59,90 €
<b>Traffic</b>								
0100205	50-559	26 x 1.9	black/black	Sport	820	3,5	4,5	24,90 €
0100207	54-559	26 x 2.1	black/black	Sport	860	3,5	4,5	24,90 €



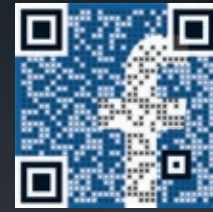

On our ContinentalMTB Facebook page you can find the latest videos of our mountain bike athletes in action, current news and inspiration for your next ride.



## SAFETYPLUS

### SafetyPlus Breaker - the specialist among Breakers

Specially developed for e-bikes up to 50 km/h, we combined our SafetySystem Breaker with highly flexible rubber. The result is a Breaker extremely resistant against cuts and piercing - with a surprisingly low rolling resistance, thanks to its high elasticity. This conserves energy and the environment. Rapid acceleration as well as high cornering speeds are no problem for the Breaker. The specialist for fast e-bikes and rental bikes.

### SafetyPlus Breaker - der Spezialist unter den Breakern

Speziell für E-Bikes bis 50 km/h haben wir unseren Safety-System-Breaker mit einem hochflexiblen Kautschuk kombiniert. Das Resultat ist ein extrem schnitt- und stichfester Breaker, der dank seiner hohen Elastizität einen geringen Rollwiderstand aufweist. Das schont die Umwelt und den Akku. Hohe Beschleunigungsmomente sowie schnelle Kurvengeschwindigkeiten steckt der Breaker problemlos weg. Der Spezialist für schnelle E-Bikes und Räder von Verleihstationen.

Safety 





# NONSTOP Mobility!

## CONTACT Plus:

**Up to 30 % better protection\* against the intrusion of shards and sharp stones!**

\* Comparative test of puncture resistance [blade], Zedler Institut 2016  
for more information visit <http://www.continental-tires.com/bicycle/technology/city-trekking/puncture-test>

**Bis zu 30 % höherer Pannenschutz\* gegen das Eindringen von Scherben und spitzen Steinen!**

\* Vergleichstest Durchstichkraft Klinge durch Zedler Institut 2016  
mehr Infos zum Test unter [www.continental-reifen.de/fahrrad/technologie](http://www.continental-reifen.de/fahrrad/technologie)

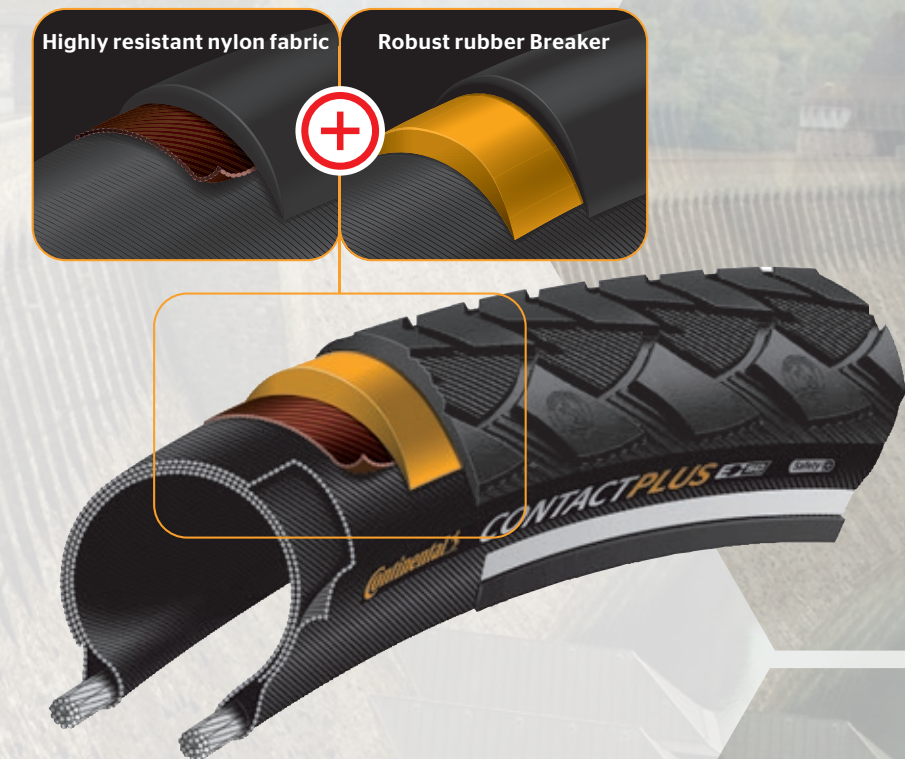

## PRODUCT FAMILIES / DIE NEUEN MODELLFAMILIEN

### The Top CONTACT Family

- > our Premium line for the highest quality standards
- > newest technology and hand-picked materials
- > Premium-Reifen für höchste Qualitätsansprüche
- > neueste Technologien und erlesene Materialien

### The CONTACT Plus Family

- > maximum puncture protection for all demands
- > maximaler Pannenschutz für jeden Anspruch

### The CONTACT Family

- > Performance tyres for the ambitious cyclist
- > Performance-Reifen für ambitionierte Radfahrer

### The RIDE Family

- > Quality for daily use
- > Qualität für den täglichen Einsatz



## PASSION AND MOBILITY

Whether it's your daily commute or your ride at the weekend, you want to keep moving and arrive safely. Our range of tyres are designed for your every need, be it your city, retro or electro bike. With a huge range of dimensions and styles, we have the right tyre for you so that you may ride with confidence on the road.

### LEIDENSCHAFT UND MOBILITÄT

Ob der tägliche Weg in der Stadt oder Ihre Tour am Wochenende – Sie möchten mit Ihrem Rad mobil sein und sicher ankommen. So facettenreich wie Ihr Bedarf sind auch unsere Reifen. Sei es Ihr City-, Retro- oder Elektrorad. Mit einer großen Palette an Dimensionen und Ausführungen haben wir die passende Bereifung, damit Sie im Straßenverkehr sicher unterwegs sind.

<b>Vectran™ BREAKER</b>	Top CONTACT II				Top CONTACT Winter II
<b>Safety+</b>	CONTACT Plus	CONTACT Plus City	CONTACT Plus Travel		
<b>Safety System</b>	CONTACT	CONTACT City	CONTACT Travel	CONTACT Cruiser	CONTACT Speed
<b>IEXTRA Puncture BELT ProTecton</b>	RIDE Tour	RIDE City		RIDE Cruiser	RIDE Classic
	ALLROUND	CITY	TOUR	BALLOON	URBAN

**CONTACT Speed**



**Speed and comfort, united in a tyre**

- > the perfect choice for the city speedsters, single-speed bikes and fitness bikes
- > double puncture protection, good grip and light-weight design
- > the roughened slick tread speeds along on tarmac

**Geschwindigkeit und Komfort, vereint in einem Reifen**

- > die perfekte Wahl für puristische Stadtfahrer, Singlespeed-Räder und Fitness-Bikes
- > with its extra puncture protection nobody will be left behind at the side of the road
- > das angeraute und schnelle Slickprofil punktet vor allem auf Asphalt

**CONTACT Plus Reflex**



**An all-rounder that offers everything that you would expect from a comfortable touring tyre**

- > an all-rounder for roads and paths that crowns every touring bike
- > with its extra puncture protection nobody will be left behind at the side of the road
- > updated version of the most popular tread design of all our touring tyres
- > ECE-R75 certified

**Ein Allrounder, der alles bietet, was Sie von einem komfortablen Tourenreifen erwarten**

- > ein Alleskönner auf Straßen und Wegen, der jedes Tourenrad adelt
- > mit seinem Plus an Pannensicherheit bleibt mit diesem Reifen niemand am Straßenrand zurück
- > Update für das beliebteste Profil unter unseren Tourenradreifen, zertifiziert und speziell für den Einsatz auf E-Bikes bis 50 km/h entwickelt
- > ECE-R75-zertifiziert



model/code	predecessor	etrto	dimension	color/sidewall	technology	weight g	bar	max. bar	price
<b>CONTACT Speed</b>									
0101412	0101098	37-622	28 x 1 3/8 x 1 5/8	black/black Skin	Double SafetySystemBreaker	520	5,0	6,0	28,90 €
0101416	0101102	42-622	700 x 42 C (40 C)	black/black Skin	Double SafetySystemBreaker	610	3,5	6,0	28,90 €
<b>CONTACT Plus</b>									
0101001		47-507	24 x 1.75	black/black Reflex	SafetyPlusBreaker	880	3,0	4,0	37,90 €
0101002		47-559	26 x 1.75	black/black Reflex	SafetyPlusBreaker	980	3,0	4,0	37,90 €
0101221		42-584	275 x 1 1/2	black/black Reflex	SafetyPlusBreaker	880	3,5	4,5	37,90 €
0101003		28-622	28 x 1 5/8 x 1 1/8	black/black Reflex	SafetyPlusBreaker	740	5,5	7,0	37,90 €
0101004		32-622	28x1 1/4 x 1 3/4	black/black Reflex	SafetyPlusBreaker	760	5,0	6,0	37,90 €
0101005		37-622	28 x 1 5/8 x 1 1/8	black/black Reflex	SafetyPlusBreaker	935	4,0	6,0	37,90 €
0101006		42-622	28 x 1.6	black/black Reflex	SafetyPlusBreaker	1.035	3,5	5,0	37,90 €
0101007		47-622	28 x 1.75	black/black Reflex	SafetyPlusBreaker	1.135	3,0	4,0	37,90 €
0101008		42-635	28 x 1 1/2	black/black Reflex	SafetyPlusBreaker	930	3,5	4,5	37,90 €
<b>CONTACT Plus Travel Reflex</b>									
101346	0100323	47-559	26 X 1.75	black/black Reflex	SafetyPlusBreaker	950	3,0	4,0	37,90 €
101347	0100438	50-559	26 X 2.00	black/black Reflex	SafetyPlusBreaker	1.000	3,0	4,0	37,90 €
101348	0100326	37-622	28 X 1 3/8 X 1 5/8	black/black Reflex	SafetyPlusBreaker	900	4,0	6,0	37,90 €

**RIDE Tour**



**Time for a RIDE trusted companion on your regular rides**

- > tarmac, unsurfaced park paths, urban surroundings - the right choice for the city cyclist on their daily ride
- > features a puncture resistant carcass and an extra layer of rubber for enduring mileage
- > available in a large range of colours and sizes

**Der Reifen ist auf jedem Untergrund zu Hause, ein echter Allrounder**

- > durchgängige Mittellauffläche bietet gleichzeitig gute Rolleigenschaften und genügend Traktion bei Kurvenfahrten
- > zuverlässiger Pannenschutz durch Extra Puncture Belt
- > widerstandsfähige Karkasse und langlebiger Laufstreifen überzeugen regelmäßig bei Ausfahrten



Assieme ai fianchi in gomma rinforzata questa fettuccia costituisce un'elevata protezione contro forature e abrasioni. Disponibile in versione di pneumatico compatto con una forte propensione per la durezza.

Tous ceux qui recherchent un compagnon de tous les jours fiable choisiront un pneumatique avec EXTRA PunctureBELT. Ce dispositif de sécurité en caoutchouc robuste, combiné avec les flancs du pneu renforcés de caoutchouc, assure un haut niveau de protection contre les crevaisons et l'abrasion des flancs. Lorsque la longévité est l'objectif principal, il existe également une version pneu plein.



model/code	predecessor	etrto	dimension	color/sidewall	technology	weight g	bar	max. bar	price
<b>RIDE Tour</b>									
0101140		47-406	20 x 1.75	black/black	Extra Puncture Belt	585	3,0	4,0	13,90 €
0101143	0109003	47-507	24 x 1.75	black/black	Extra Puncture Belt	710	3,0	4,0	17,90 €
0101148		47-559	26 x 1.75	black/black	Extra Puncture Belt	805	3,0	4,0	17,90 €
0101146	0111348	42-584	26 x 1 1/2	black/black	Extra Puncture Belt	675	3,5	4,5	17,90 €
0101150	0100100	54-584	26 x 1 1/2 x 2	black/black	Extra Puncture Belt	940	3,0	4,0	17,90 €
0101151		28-622	700x28C (700C)	black/black	Extra Puncture Belt	510	5,0	5,5	17,90 €
0101153		32-622	28 x 1 1/4 x 1 3/4	black/black	Extra Puncture Belt	570	5,0	5,5	17,90 €
0101155		37-622	28 x 1 3/8 x 1 5/8	black/black	Extra Puncture Belt	650	4,0	5,0	17,90 €
0101177	0122299	37-622	28 x 1 3/8 x 1 5/8	creme/creme	Extra Puncture Belt	650	4,0	5,0	17,90 €
0101157		42-622	28 x 1.6	black/black	Extra Puncture Belt	720	3,5	4,5	17,90 €
0101159		47-622	28 x 1.75	black/black	Extra Puncture Belt	910	3,0	4,0	17,90 €
0101179	0111354	47-622	28 x 1.75	black/brown	Extra Puncture Belt	910	3,0	4,0	17,90 €
<b>RIDE Tour Reflex</b>									
0101152		28-622	700x28C (700C)	black/black Reflex	Extra Puncture Belt	510	5,0	5,5	20,90 €
0101154		32-622	28 x 1 1/4 x 1 3/4	black/black Reflex	Extra Puncture Belt	570	5,0	5,5	20,90 €
0101156	0122292	37-622	28 x 1 3/8 x 1 5/8	black/black Reflex	Extra Puncture Belt	650	4,0	5,0	20,90 €
0101167		42-622	28 x 1.6	black/black Reflex	Extra Puncture Belt	720	3,5	4,5	20,90 €
0101160	0111347	47-622	28 x 1.75	black/black Reflex	Extra Puncture Belt	910	3,0	4,0	20,90 €
0101162	0100091	32-630	27 x 1 1/4	black/black Reflex	Extra Puncture Belt	570	5,0	5,5	20,90 €
0101164	0100095	37-635	28 x 1 3/8	black/black Reflex	Extra Puncture Belt	655	4,0	5,0	20,90 €
0101166	0126102	42-635	28 x 1 1/2	black/black Reflex	Extra Puncture Belt	725	3,5	4,5	20,90 €

# PASSION AND PRACTICAL ACCESSORIES

Small details make the difference. Be it seating the tyre on the rim, or repair jobs, on the road or at home, your tyres get the best service and support. In the next few pages you will find useful accessories to help make the practical aspects of your sport as hassle-free as possible. From the correct tube, the right rims, to the matching tyre lever and an effective sealant, we have something for your next project.

## LEIDENSCHAFT UND PRAKTISCHE HELFER

Die Details machen den Unterschied. Ob zur Montage oder Reparatur, unterwegs oder zu Hause: Ihre Reifen verdienen den besten Service und Support. Auf den folgenden Seiten finden Sie praktische Helfer, die Sie dabei unterstützen, Ihren Sport so komfortabel wie möglich ausüben zu können. Vom passenden Schlauch über Felgenbänder bis zum Reifenheber und einer effektiv arbeitenden Dichtmilch – wir haben da was für Ihr nächstes Projekt.

Inner tubes for bicycles and accessories / Schläuche für Fahrräder und Zubehör

## Air chambers / Schläuche

model/code	etrto	dimension	description	price
<b>MTB</b>				
0181631	47-559 > 62-559	S42	MTB 26	7,50 €
0181671	47-559 > 62-559	S60	MTB 26	8,50 €
0182311	47-584 > 62-584	S42	MTB 27,5	7,50 €
0182181	47-622 > 62-662	S42	MTB 28 / 29 inch	7,50 €
0182191	47-622 > 62-662	S60	MTB 28 / 29 inch	8,50 €
<b>Tour</b>				
0181521	37-559 > 47-597	S42	Tour 26	7,50 €
0182031	32-622 > 47-622	S42	Tour 28 all	7,50 €
<b>Race</b>				
0181781	18-622 > 25-630	S42	Race 28	7,50 €
0181791	18-622 > 25-630	S60	Race 28	8,50 €
0180000	18-622 > 25-630	S80	Race 28	9,50 €
0181821	18-622 > 25-630	S42	Race 28 Light	9,50 €
0181831	18-622 > 25-630	S60	Race 28 Light	10,50 €
0181871	18-622 > 25-630	S80	Race 28 Light	12,50 €
<b>Race 28 Super Sonic</b>				
0181881	18-622 > 25-630	S42	Race 28	14,50 €
0181891	18-622 > 25-630	S60	Race 28	15,50 €

### Tubular Kit



Tube bag

### Conti RevoSealant



## Accessories / Zubehör

model/code	description	weight g	price
<b>Tubular kit</b>			
0149091	Rim cement for aluminium / tubo da 25 g	25	2,90 €
0149092	Rim cement for aluminium / barattolo da 350 g	350	16,90 €
0140016	Rim cement for carbonrims / tubo da 25 g	25	2,90 €
0140017	Rim cement for carbonrims / barattolo da 250 g	250	16,90 €
<b>Tube bag</b>			
0100388	Tube bag / Race 28 S42 tube and 2 tire lever race	160	9,90 €
0101026	Tube bag with MTB 29 tube S42 and 2 tire levers MTB	320	10,90 €
<b>Sealant</b>			
0140089	Continental RevoSealant 60 ml	60 ml	5,90 €
0140044	Continental RevoSealant 240 ml	240 ml	10,00 €
0140050	Continental RevoSealant 1000 ml	1.000 ml	35,90 €
<b>Others</b>			
0140033	Valve extension for presta valve aluminium 40 mm / 10 pcs	-	44,90 €
0149690	Exchangeable presta valve insert / bag of 10 pcs	10	5,50 €
0140030	Valve extension for presta valve aluminium 30 mm, 2pcs	30	9,90 €
0140032	Valve extension for presta valve aluminium 40 mm, 2pcs	40	9,90 €
0140034	Valve extension for presta valve aluminium 60 mm, 2pcs	60	10,90 €



## PASSION AND TECHNOLOGY FROM GERMANY

Producing the best tyres is only just good enough for us. That's why our designers and engineers are always working continuously to make our products even more efficient, developing new or improved formulations for our rubber compounds for example. These changes are not always visible at first glance, but they are definitely noticeable. Ride the difference, ride "handmade in Germany".

### LEIDENSCHAFT UND TECHNOLOGIE AUS DEUTSCHLAND

Technologisch hochfeine Reifen herzustellen, ist uns gerade gut genug. Deswegen arbeiten unsere Entwickler und Ingenieure auch kontinuierlich daran, unsere Produkte noch effizienter zu gestalten. Mit neuen oder verbesserten Rezepturen für unsere Gummimischungen beispielsweise. Nicht immer sind diese Änderungen auf den ersten Blick sichtbar. Spürbar sind sie auf jeden Fall. Fahren Sie den Unterschied - handmade in Germany.



# TECHNOLOGY MADE IN GERMANY IT'S ALL ABOUT HOW YOU MIX IT

## TECHNOLOGIE MADE IN GERMANY. DEUTSCHE TECHNIK IM DETAIL

### Well built [carcass design]

The carcass - the basic element and backbone of all tyres. Their respective designs, the material used and the fibre density depend on the requirements to be fulfilled by the tyre. In order that our products give enduring cycling pleasure, we only work with high quality carcasses of woven and then rubberized nylon threads. The thread density of the nylon casing material gives the tyre its specific properties. Yarn density is specified in TPI [Threads per inch] and denotes the number of threads per 2.54 cm. A three-layer base carcass serves as a standard. Very fine fabric makes the tyre supple and fortifies the carcass against punctures. Coarse fabric is more cut resistant and makes the tyre durable. Additionally, we use anti-puncture breakers beneath the tread, made of various material to reinforce the tyre further. The structure of the tyre can be found in the individual specifications. The number of layers are specified, the total of the TPI and the type of puncture protection: 3/330 + Vectran™ means three layers of 110 TPI fabric with additional Vectran™ Breaker.

### Gut gebaut [Karkasskonstruktion]

Ohne Karkasse geht nichts. Sie bildet das Grundgerüst aller Reifen. Ihre jeweilige Konstruktion, das verwendete Material und die Fadendichte sind dabei abhängig von den Anforderungen, die an den späteren Reifen gestellt werden. Damit unsere Produkte lange Freude machen, arbeiten wir durchgängig nur mit hochwertigen Karkassen aus gewebten und anschließend gummierten Nylonfäden. Die Fadendichte des Nylons gibt dem Reifen seine spezifischen Eigenschaften. Die Angabe der Fadendichte erfolgt in TPI [Threads per Inch] und bezeichnet die Anzahl der Fäden pro 2,54 cm. Als Standard dient eine dreilagige Basiskarkasse. Sehr feines Gewebe macht den Reifen geschmeidig und wappnet die Karkasse vor Durchstichen. Grobes Gewebe ist schnittfester und macht den Reifen robust. Zusätzlich verwenden wir Breaker unter der Lauffläche, um den Reifen weiter zu verstärken und den Pannenschutz zu erhöhen. Den Aufbau des Reifens können Sie seinen individuellen Spezifikationen entnehmen. Angegeben werden die Anzahl der Lagen, die Summe der TPI und die Art des Pannenschutzes: 3/330 + Vectran™ bedeutet drei Lagen eines 110-TPI-Gewebes mit zusätzlichem Vectran™ Breaker.

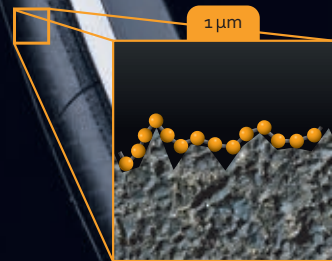
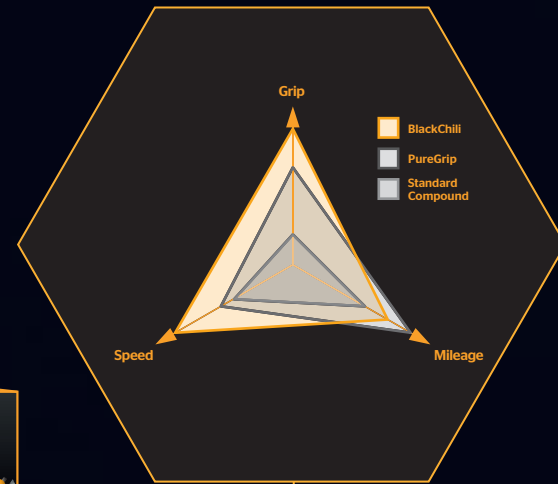

### TWI [Tread Wear Indicators] the indicator for tread wear

Two circular depressions in the middle of the tread. If these are no longer visible, it's time for a change of tyre [segment Road Racing].  
As it is the case with cars, there are small bars in the tread, indicating a minimum tread depth of 1.6 mm [segment City/ Trekking].



### TWI [Tread Wear Indicators] die Verschleißanzeiger

Zwei kreisrunde Vertiefungen in der Mitte des Laufstreifens. Sind diese nicht mehr erkennbar, wird es Zeit für einen Reifenwechsel [im Segment Rennrad].  
Wie beim Auto - kleine Stege im Profilgrund, die eine Mindestprofiltiefe von 1,6 mm anzeigen [Segment City/Trekking].

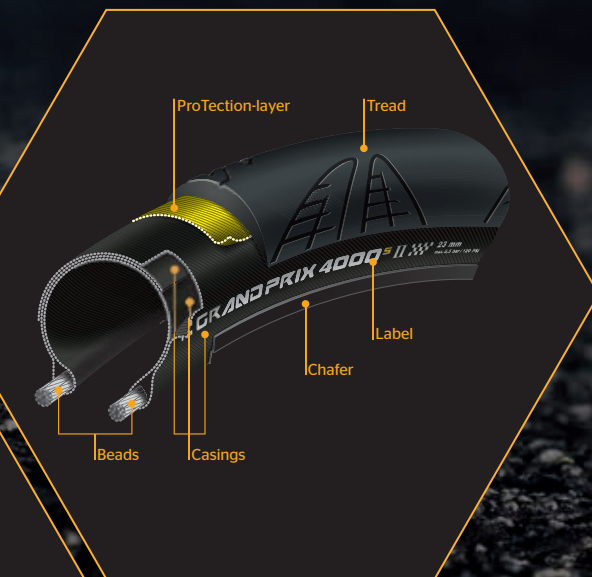

DIE IN DIESER BROSCHÜRE ENTHALTENEN INFORMATIONEN DÜRFEN KEINESFALLS DIE DIREKTE KOMMUNIKATION ZWISCHEN MEDIZINISCHEM FACHPERSONAL UND PATIENT ERSETZEN. ES SOLLTE DAHER STETS DER BEHANDELNDE ARZT UND/ODER APOTHEKER ZU RATE GEZOGEN WERDEN.

**NAMEDSPORT®**  
SUPERFOOD

## NAMEDSPORT> Superfood Wir nähren Leidenschaft.

Mit gezielten, qualitativ hochwertigen Produkten, die einem ausgesprochen innovativen Konzept entspringen, bietet NAMEDSPORT> Superfood dem Sportler eine komplette, ausgewogene Ernährung an, so dass eine optimale athletische Leistung und alle nötigen Nährstoffe vor, während und nach der sportlichen Aktivität garantiert werden. Die Supplements von **NAMEDSPORT>** tragen dazu bei, die Performance und die Regenerationszeiten zu optimieren und fördern einen Zustand allgemeinen Wohlbefindens. Es handelt sich um bahnbrechende, wirksame Produkte aus erstklassigen Rohstoffen, die dank einer unermüdlichen Forschungstätigkeit in Zusammenarbeit mit einem aus Fitnesstrainern, Sportmedizinern, wissenschaftlichen Forschern, Physiotherapeuten und Ernährungswissenschaftlern bestehenden Expertenteam entstanden sind. Ihre Wirksamkeit - mit den geltenden Bestimmungen und der Rücksichtnahme auf die Gesundheit völlig im Einklang - wird Tag für Tag von Sportlern auf höchstem Niveau bezeugt.

**NAMEDSPORT>**, Hauptsponsor des 100. Giro d'Italia, wurde von den angesehensten Pro-Tour-Teams weltweit, wie Astana, Trek-Segafredo, Bahrain-Merida und UAE Team Emirates, als Ernährungspartner gewählt.

**NAMEDSPORT>** Wir nähren Leidenschaft für Ihre Leidenschaften.



Alle Supplements von NAMEDSPORT> sind beim Gesundheitsministerium gemeldet und erfüllen die nationalen und europäischen Vorschriften für Nahrungsergänzungsmittel.



**LA VUELTA**  
OFFICIAL SPONSOR

## Ernährung und Sport

Für Athleten ist eine korrekte, ausgewogene Ernährung noch wichtiger als für Menschen mit wenig Bewegung. Sie garantiert dem Körper eine angemessene Zufuhr der notwendigen Nährstoffe, um die physiologischen Funktionen auszuüben, den Erhalt oder das Wachstum der Muskelmasse zu fördern, die Leistung zu optimieren und eventuelle Mangelerscheinungen durch die bei intensiver sportlicher Aktivität entstehende psychophysische Belastung auszugleichen. Der korrekte Stoffwechsel der Makronährstoffe (Kohlenhydrate, Proteine und Fette) und deren Umwandlung in Glucose und Glykogen zur Energiegewinnung stellen grundlegende Prozesse dar, um Athleten die nötige Kraft für ihre Aktivität, sowohl während des Trainings als auch im Wettkampf, zu liefern.

Sich ausgewogen zu ernähren bedeutet, täglich seinen Speiseplan zu ändern und die Lebensmittel häufig abzuwechseln - Getreide, Hülsenfrüchte, Milch, Obst und Gemüse - um sicher zu sein, dass man alle nötigen Nährstoffe aufnimmt.

Bei Menschen, die Sport treiben, kann der tägliche Kalorienbedarf zwischen 2.000 und 5.000 kcal schwanken, was vom Geschlecht, vom Alter und von der Intensität und Dauer der Belastung abhängig ist. Das Konzept der "Energiebilanz" bringt die Notwendigkeit zum Ausdruck, die Menge der aufgenommenen Nahrung an die ausgeübte Aktivität und die verbrauchte Energie anzupassen. Bisweilen erschweren ein stressiger Lebensstil, intensive Berufstätigkeit, sowie ein hektischer und unregelmäßiger Tagesablauf eine korrekte, ausgewogene Ernährung. Dadurch sinkt die Möglichkeit einer ausgewogenen Zufuhr von Nährstoffen, die für das Wohlbefinden und die Ausübung der Aktivitäten unerlässlich sind.



Official Sponsor of



## NAMEDSPORT> durch INFORMED-SPORT zertifizierte Qualität.

**Informed-Sport** Informed-Sport ist ein weltweit anerkanntes Zertifizierungsprogramm zur Zertifizierung von Produkten, Lieferanten und Produktionsstätten im Bereich der Sporternährung. Ergänzungsmittel, die mit dem Siegel "Informed-Sport" gekennzeichnet sind, bieten die Gewährleistung, dass mehr als 146 im Sport verbotene Substanzen auf keinen Fall in ihrer Zusammensetzung enthalten sind. Informed-Sport ist ein seit mehr als 50 Jahren international tätiges Forschungs- und Dopingkontrolllabor.

Immer mehr Sportler, Profis und Amateure suchen nach hochwertigen Ergänzungsmitteln für ihre Diät und vertrauen dabei auf die Ernsthaftigkeit von **NAMEDSPORT>**, das sich seit jeher für eine sorgfältige Auswahl der besten Rohstoffe und einer strengen Kontrolle aller Produktionsphasen einsetzt.

Aus diesem Grund hat sich **NAMEDSPORT>** um die Erlangung der Zertifizierung "Informed-Sport" bemüht, die eine weitere Garantie für die eigenen Produkte darstellt, die kontinuierlich einer großen Anzahl von Tests und Analysen unterzogen werden. Die Ergebnisse werden für jede Produktionscharge in Echtzeit auf der dedizierten Website [www.informed-sport.com](http://www.informed-sport.com) veröffentlicht.

**NAMEDSPORT>** war der erste italienische Markenhersteller, der diese bedeutende Zertifizierung mit dem Produkt HydraFit> erhalten hat, später gefolgt von Omega 3 Double Plus und CreaFast®: Ein wachsendes Engagement, das das Bemühen von **NAMEDSPORT>** zum Ausdruck bringt, den Endverbrauchern hochwertige Produkte zu garantieren, die bedenkenlos eingenommen werden können.



## Cluster 1 >



**code** SP500bis  
**description** Cluster 1  
**box** 60  
**prix per box** 5,99 €

### Cluster 1 > contains:

PalBox KIT HYDRAFIT / 60x400g



100%  
Batch tested:  
**INFORMED-SPORT**  
Trusted by sport

**+ MAGNÉSIUM + POTASSIUM**

WITH VITAMINS WITH MINERALS GLUTEN FREE  
 ASPARTAME FREE ACESULFAME FREE LACTOSE FREE

## Cluster 2 >



**code** NAMCLUS020000  
**description** Cluster 2

### Cluster 2 > contains:

code	description		box
K013	AMINONAM SPORT	30 sachet	1
SP917	CREAMY PROTEIN 80 Exquisite Chocolate	500g	1
SP919	CREAMY PROTEIN 80 Cookies & Cream	500g	1
SP82	MALTONAM	500g	1
SP12	ISONAM ENERGY Lemon	480g	1
SP13	ISONAM ENERGY Orange	480g	1
SP21	4FUEL	20 sachet	1
SP151	TOTAL ENERGY SHOT Orange	60ml	50
SP692	PROTEINBAR Cookies & Cream	50g	12
SP8341	TOTAL ENERGY FRUIT BAR Cranberry & Nuts	35g	25
SP8361	TOTAL ENERGY FRUIT BAR Yellow Fruits	35g	25
SP8381	TOTAL ENERGY CARBO GEL Agrumix	40ml	24
SP9361	TOTAL ENERGY AMINO GEL Orange Flavour	50ml	32
SP9381	SPORT GEL Orange	25ml	15
SP9402	SPORT GEL Cola Lime	25ml	15
ES-44	Display	-	1



**Snack**



protein  
**32%**

BEFORE DURING AFTER



**Durchschnittliche Nährwerte**

	Pro 100 g	Pro Riegel (40 g)
<b>Brennwert</b>	<b>1819 kJ/ 435 kcal</b>	<b>730 kJ/173 kcal</b>
<b>Fett</b>	<b>17 g</b>	<b>6,8 g</b>
davon gesättigte Fettsäuren	10 g	4 g
<b>Kohlenhydrate</b>	<b>38 g</b>	<b>15 g</b>
davon Zucker	24 g	10 g
<b>Ballaststoffe</b>	<b>0,9 g</b>	<b>&lt; 0,5 g</b>
<b>Eiweiß</b>	<b>32 g</b>	<b>13 g</b>
<b>Salz</b>	<b>0,5 g</b>	<b>0,19 g</b>

## Crunchy Protein Bar

Köstlicher Proteinriegel mit 32% Eiweißanteil. Unter dem krossen Schokoladenüberzug verbirgt sich eine weiche Füllung auf der Basis von Sojaprotein-Isolat und Milchprotein-Konzentrat mit hoher biologischer Wertigkeit, was den Erhalt der Muskelmasse fördert.

- > **32% Eiweißanteil pro Riegel**
- > **Ideal als Proteinergänzung nach dem Workout**
- > **Leicht verdaulich**
- > **Geringe Fett- und Zuckerzufuhr**

GREAT TASTE ASPARTAME FREE ACESULFAME FREE

code	description	content	box	price
SP799	Crunchy Proteinbar Capuccino	40g	24	€ 2,80
SP792	Crunchy Proteinbar Lemon-Tarte	40g	24	€ 2,80
SP796	Crunchy Proteinbar Raspberry Dream	40g	24	€ 2,80

protein  
**35%**

BEFORE DURING AFTER



## Proteinbar

Proteinriegel auf der Basis von Molkenprotein-Isolat und -Konzentrat, mit kaltgepresstem Sonnenblumenöl, überzogen mit Bitterschokolade.

- > **35% Proteinanteil**
- > **17g Proteine pro Riegel**
- > **Ideal vor und nach dem Training**
- > **Perfekter Snack für zwischendurch**
- > **Mit hohem Proteingehalt, ausgewogene Kohlenhydrate**

GREAT TASTE ASPARTAME FREE ACESULFAME FREE GLUTEN FREE PALM OIL FREE

code	description	content	box	price
SP651	Proteinbar Coconut	50g	12	€ 2,60
SP692	Proteinbar Cookies & Cream	50g	12	€ 2,60
SP631	Proteinbar Delicious Pistachio	50g	12	€ 2,60
SP641	Proteinbar Superior Choco	50g	12	€ 2,60
SP661	Proteinbar Wild Berries	50g	12	€ 2,60

**Durchschnittliche Nährwerte**

	Pro 100 g	Pro Riegel (50 g)
<b>Brennwert</b>	<b>1636 kJ/390 kcal</b>	<b>818 kJ/195 kcal</b>
<b>Fett</b>	<b>12 g</b>	<b>6,2 g</b>
davon gesättigte Fettsäuren	4,0 g	2,0 g
<b>Kohlenhydrate</b>	<b>34 g</b>	<b>17 g</b>
davon Zucker	30 g	15 g
<b>Ballaststoffe</b>	<b>7,0 g</b>	<b>3,5 g</b>
<b>Eiweiß</b>	<b>34 g</b>	<b>17 g</b>
<b>Salz</b>	<b>25 mg</b>	<b>12 mg</b>

30%  
PROTEIN  
PLANT-BASED

BEFORE DURING AFTER



**Durchschnittliche Nährwerte**

	Pro 100 g	Pro Riegel (40 g)
<b>Brennwert</b>	<b>1610 kJ/382 kcal</b>	<b>644 kJ/153 kcal</b>
<b>Fett</b>	<b>10 g</b>	<b>4 g</b>
davon gesättigte Fettsäuren	3,3 g	1,3 g
<b>Kohlenhydrate</b>	<b>45 g</b>	<b>18 g</b>
davon Zucker	18 g	7 g
<b>Eiweiß</b>	<b>29 g</b>	<b>12 g</b>
<b>Salz</b>	<b>1 g</b>	<b>0,44 g</b>

## Vegan Bar

Leckere Proteinriegel mit 30% Eiweißanteil, ideal im Rahmen einer vegetarischen und veganen Ernährung. Dank der Nährwertigenschaften von Soja- und Erbsenproteinen bieten die Vegan Bars ein komplettes Nährstoffprofil und sind vor allem für Menschen gedacht, die auf Wohlbefinden und Fitness achten.

- > **30% Anteil an Soja- und Erbsenproteinen**
- > **Ohne Palmöl**
- > **100 Prozent vegan**
- > **Mit echter Frucht**
- > **Äußerst wohlschmeckend**

GREAT TASTE ASPARTAME FREE ACESULFAME FREE GLUTEN FREE PALM OIL FREE

code	description	content	box	price
SP794	Vegan Protein Bar Nuts	40g	24	€ 3,00
SP793	Vegan Protein Bar Red Fruits	40g	24	€ 3,00



Official Sponsor of

**Filippo Ganna.**  
UAE Team Emirates  
Weltmeister der individuellen  
Verfolgung 2016



BEFORE DURING AFTER

FAST ENERGY

WITH REAL FRUIT



- + VITAMINE C
- + VITAMINE B1
- + VITAMINE B6

**Durchschnittliche Nährwerte**

	Pro 100 g	Pro Riegel (35 g)	% NRV*
<b>Brennwert</b>	<b>1414 kJ/ 335 kcal</b>	<b>495 kJ/ 117 kcal</b>	
<b>Fett</b>	<b>6 g</b>	<b>2,1 g</b>	
davon gesättigte Fettsäuren	0,6 g	0,2 g	
<b>Kohlenhydrate</b>	<b>64 g</b>	<b>22,4 g</b>	
davon Zucker	48 g	16,8 g	
<b>Ballaststoffe</b>	<b>4,5 g</b>	<b>1,6 g</b>	
<b>Eiweiß</b>	<b>4 g</b>	<b>1,4 g</b>	
<b>Salz</b>	<b>0,25 g</b>	<b>0,09 g</b>	
Vitamin C	35 mg (43% NRV)	12 mg	15%
Thiamin	0,48 mg (43% NRV)	0,17 mg	15%
Vitamin B6	0,60 mg (43% NRV)	0,21 mg	15%

\* NRV: Nutrient Reference Values (empfohlene Tagesdosis laut Verordnung (EU) Nr. 1169/2011)

## Total Energy Fruit Bar

Schmackhafter Energieriegel mit Rice Krispies und echter Frucht, angereichert mit Vitamin B1, B6 und Vitamin C; insbesondere vor und während des Trainings geeignet, um bei sportlicher Aktivität schnell Energie zuzuführen.

- > **Ideal bei Ausdauersport**
- > **Mit Vitamin B1 und B6 als Energiespender**
- > **Mit Vitamin C als Oxidationshemmer**
- > **Vitamin B6 trägt zur Reduzierung von Müdigkeit und Erschöpfung bei**
- > **Vitamin B1 fördert den Energiestoffwechsel**

GREAT TASTE ASPARTAME FREE ACESULFAME FREE

code	description	content	box	price
SP8341	Total Energy Fruit Bar Cranberry & Nuts	35g	25	€ 2,00
SP8371	Total Energy Fruit Bar Fruit Caribe	35g	25	€ 2,00
SP8351	Total Energy Fruit Bar Fruit Tango	35g	25	€ 2,00
SP8361	Total Energy Fruit Bar Yellow Fruits	35g	25	€ 2,00

BEFORE DURING AFTER

FAST ENERGY

30g CARBS



**Durchschnittliche Nährwerte**

	Pro 100 g	Pro Riegel (35 g)
<b>Brennwert</b>	<b>1613 kJ/381 kcal</b>	<b>564 kJ/133 kcal</b>
<b>Fett</b>	<b>2,8 g</b>	<b>1,0 g</b>
davon gesättigte Fettsäuren	0,5 g	0,2 g
<b>Kohlenhydrate</b>	<b>85 g</b>	<b>30 g</b>
davon Zucker	45 g	16 g
<b>Ballaststoffe</b>	<b>4,0 g</b>	<b>1,4 g</b>
<b>Eiweiß</b>	<b>2,0 g</b>	<b>0,7 g</b>
<b>Salz</b>	<b>350 mg</b>	<b>122 mg</b>

## Energybar

Leckerer Energieriegel auf Kohlenhydratbasis, mit Puffreis und Fruchtmas. Ideal, um dem Sportler vor und während des Trainings Energie zu spenden.

- > **30g Kohlenhydrate pro Riegel**
- > **Ideal bei Ausdauersport**
- > **Mit niedrigem Fettgehalt**
- > **Köstlich als Energie-Snack**

GREAT TASTE ASPARTAME FREE ACESULFAME FREE

code	description	content	box	price
SP5311	Energybar Apricot	35g	12	€ 1,90
SP5411	Energybar Banana	35g	12	€ 1,90
SP5511	Energybar Strawberry	35g	12	€ 1,90



# Aminosäuren



Official Sponsor of **TREK** **Segafredo**

BEFORE DURING AFTER

VITAMIN B6

ANTI CATABOLIC POOL



**Durchschnittliche Nährwerte**

	Pro 100 g	Pro 16 g (dose max/die)	% NRV**
Brennwert	379kJ/89,7kcal	60,7kJ/14,3kcal	--
Fett	1,5 g	0,24 g	--
davon gesättigte Fettsäuren	1,3 g	0,20 g	--
Kohlenhydrate	7,81 g	1,25 g	--
davon Zucker	0,40 g	0,06 g	--
Eiweiß	0,0 g	0,0 g	--
Salz	2,34 g	0,375 g	--

\* AJINOMOTO® Aminosäuren  
\*\* NRV: Nutrient Reference Values (empfohlene Tagesdosis laut Verordnung (EU) Nr. 1169/2011 Anmerkung: Kcal aus organischen Säuren (Zitronensäure) sind im Brennwert mitgerechnet.

## Aminonam Sport

Aminonam Sport ist ein exklusiver Pool von reinen, sorgfältig ausgewählten Aminosäuren Ajinomoto® mit Zusatz von Vitaminen der B-Gruppe, ideal zur Unterstützung eines normalen Energiestoffwechsels.

- > **Fördert den normalen Energiestoffwechsel dank der Vitamine B1, B6 und B12**
- > **Hilft, Müdigkeit und Erschöpfung zu reduzieren, was den Vitaminen B6 und B12 zu verdanken ist**
- > **Vitamin B6 fördert den normalen Eiweiß- und Glykogenstoffwechsel**

GLUTEN FREE LACTOSE FREE WITH BCAA WITH VITAMINS NO SUGAR ADDED

code	description	content	box	price
K013	Aminonam Sport	30 sachet	1	€ 39,99

**Aminosäureprofil**

	Pro 100 g	Pro 16 g (dose max/die)	% NRV**
Vitamin B6	8,75 mg (625% NRV)	1,4 mg	100
Thiamin	6,87 mg (625% NRV)	1,1 mg	100
Vitamin B12	15,62 mcg (625% NRV)	2,5 mcg	100
L-Leucin*	15,62 g	2,500 mg	--
L-Alanin*	15,62 g	2,500 mg	--
L-Lysin HCL*	10,15 g	1,624 mg	--
L-Isoleucin*	7,81 g	1,250 mg	--
L-Valin*	7,81 g	1,250 mg	--
L-Glycin*	6,25 g	1,000 mg	--
L-Threonin*	4,37 g	700 mg	--
L-Tyrosin*	3,75 g	600 mg	--
L-Taurin*	2,50 g	400 mg	--
L-Histidin*	1,87 g	300 mg	--
L-Cystein*	1,56 g	250 mg	--
L-Arginin*	1,25 g	200 mg	--
L-Glutamin*	1,25 g	200 mg	--
L-Phenylalanin*	1,12 g	180 mg	--
L-Methionin*	0,94 g	150 mg	--
L-Tryptophan*	0,37 g	60 mg	--

BEFORE DURING AFTER

ANTICATABOLIC AMINO ACIDS

FERMENTED GLUTAMINE



180 MESH

## L-Glutamine

L-Glutamine ist ein Ergänzungsmittel aus L-Glutamin KyowaQuality®.

- > **Fein zermahlen, 100% Prozent rein**
- > **Laktosefrei**
- > **Optimale Löslichkeit**
- > **Schnelle Aufnahme**

Glutamin ist die im Muskelgewebe vorherrschende Aminosäure und kann bei sportlicher Aktivität nützlich sein, wenn die Einnahme:

- > **Eine Stunde vor Beginn der Belastung zusammen mit Kohlenhydraten erfolgt.**
- > **Sofort bzw. innerhalb von 30 Minuten nach dem Training zusammen mit reichlich Flüssigkeit und Aminosäuren erfolgt.**
- > **Nüchtern, vor dem Schlafengehen erfolgt.**

code	description	content	box	price
SP421	L-Glutamine	250g	1	€ 25,99

### Durchschnittlicher Gehalt

	pro 1 Meßlöffel (max. Tagesdosis)	Pro 100 g
L-Glutamin*	5 g	100 g

\* L-Glutamine KyowaQuality®

BEFORE DURING AFTER

VITAMIN B6

FERMENTED BCAA PREPARATE

SUPER CHARGED FORMULA



### Durchschnittlicher Gehalt

	pro max. Tagesdosis (5 Tabl.)	% NRV**
L-Leucin*	3333 mg	--
L-Isoleucin*	833 mg	--
L-Valin*	833 mg	--
Vitamin B6	1,4 mg	100

\* AJINOMOTO® Aminosäuren  
\*\* NRV: Nutrient Reference Values (empfohlene Tagesdosis laut Verordnung (EU) Nr. 1169/2011 Anmerkung: Kcal aus organischen Säuren (Zitronensäure) sind im Brennwert mitgerechnet.

## BCAA 4:1:1 extreme PRO

BCAA 4:1:1 extremePRO ist ein Ergänzungsmittel aus verzweigtkettigen Aminosäuren Ajipure® (1 g/Tablette) von höchster Reinheit: Es ist frei von Fetten, Kohlenhydraten, Gluten und Laktose.

- > **Verzweigtkettige Aminosäuren sind an den Prozessen der Proteinbiosynthese beteiligt**
- > **Unterstützt die Regenerationsphase**
- > **Vitamin B6 wirkt Müdigkeit und Erschöpfung entgegen**
- > **Verstärkte Formel 4:1:1 Plus Leucin**

BCAA 4:1:1 extremePRO enthält Vitamin B, das am Energiestoffwechsel von Kohlenhydraten, Lipiden und Proteinen und an der Synthese von Hämoglobin und roten Blutkörperchen beteiligt ist.

VEGAN FRIENDLY GLUTEN FREE LACTOSE FREE WITH VITAMIN B6 NO SUGAR ADDED



code	description	content	box	price
SP604	BCAA 4:1:1 extremePRO	110 cpr	1	€ 26,99

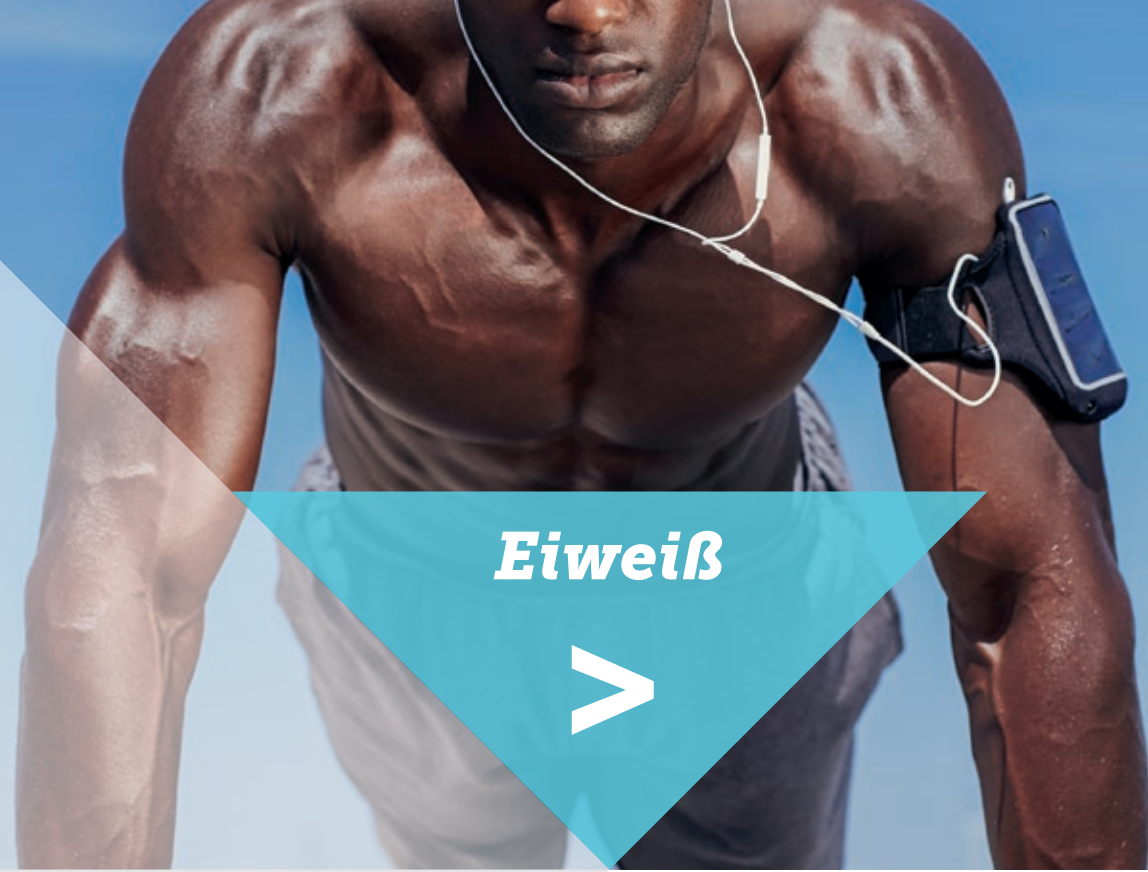

## Eiweiß



## Mind the shape

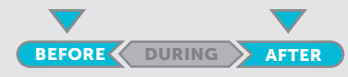

## Star Whey PERFECT ISOLATE 100%

THE PUREST ISOLATE PROTEIN FORMULA

Aus der Forschungstätigkeit von Named ist Star Whey PERFECT ISOLATE 100% hervorgegangen: Molkenprotein-Isolat reiner Qualität CARBERY® Isolac 90, gewonnen durch Querstrom-Mikrofiltration (Cross-Flow-Micro-filtration - CFM™), das sich durch einen unübertrefflichen Reinheitsgrad auszeichnet. Dank des besonderen Gewinnungsverfahrens kann ein Produkt mit hervorragender Qualität erreicht werden, das die höchste biologische Wertigkeit (119) und ein komplettes Aminosäureprofil aufweist. Star Whey ist mit der exklusiven, patentierten Formulierung Named 4 Protein Matrix® auf der Basis von Protease, Bockshornklee-Extrakt und Rindercolostrum angereichert.

- > Eiweiße fördern den Erhalt der Muskelmasse
- > Hohe biologische Wertigkeit des Proteins
- > Breites Aminosäurespektrum
- > Geringe Laktose- und Fettzufuhr
- > Leicht verdaulich
- > Mit der exklusiven Mischung Named 4 Protein Matrix® angereichert
- > Enrichi avec la combinaison exclusive Named 4 Protein Matrix®

ASPARTAME FREE ACESULFAME FREE WITH VITAMINS INSTANTLY SOLUBLE GLUTEN FREE  
 RAPID DIGESTION RICH IN BCAA NO SUGAR ADDED LOW LACTOSE WITH ENZYMES

code	description	content	box	price
SP809	Star Whey Isolate Cookies & Cream	750g	1	€ 46,99
SP808	Star Whey Isolate Sublime Chocolate	750g	1	€ 46,99

### Durchschnittlicher Gehalt an Aminosäuren

	Pro 100 g	Pro 25 g	Pro 100 g	Pro 25 g
Alanin	4,50 g	1,13 g	Methionin	1,43 g
Arginin	1,56 g	0,39 g	Phenylalanin	2,46 g
Asparaginsäure	9,40 g	2,35 g	Prolin	5,03 g
Cystein	2,07 g	0,52 g	Serin	3,73 g
Glutaminsäure	16,80 g	4,20 g	Threonin	6,73 g
Glycin	1,40 g	0,35 g	Tryptophan	1,63 g
Histidin	1,54 g	0,39 g	Tyrosin	2,96 g
Isoleucin	5,70 g	1,43 g	Valin	5,00 g
Leucin	9,30 g	2,32 g	Ges. BCAA	19,97 g
Lysin	8,26 g	2,07 g		

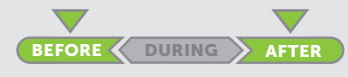

HIGH BIOLOGICAL VALUE

LACTOSE FREE

SOURCE OF BCAA

LOW G.I.

## Creamy Protein 80

5 NATURAL BLEND + STEVIA\*

Creamy Protein 80, eine exklusive Mischung auf der Basis von 5 natürlichen Proteinquellen mit unterschiedlicher Absorptionsgeschwindigkeit, fördert den Erhalt der Muskelmasse mit geringer Zucker- und Fettzufuhr. Diese Formulierung ist besonders geeignet, um den Proteinbedarf vor und nach körperlicher Aktivität zu decken. Sie ist an verzweigtkettigen Aminosäuren natürlich reich und trägt außerdem dazu bei, Muskelkatabolismus zu verhindern. Dank einer außerordentlich cremigen Beschaffenheit und eines hohen Sättigungsvermögens ist das Produkt für Diäten mit geringer Kalorienzufuhr ideal. Mit natürlichem Süßstoff (Steviolglycoside).

- > Molkenprotein-Konzentrat
- > Calciumcaseinat
- > Milchprotein-Konzentrat
- > Molkenprotein-Isolat
- > Eiprotein

ASPARTAME FREE ACESULFAME FREE INSTANTLY SOLUBLE LOW FAT TIME RELEASE  
 HIGHLY DIGESTIBLE NO SUGAR ADDED GREAT TASTE

code	description	content	box	price
SP919	Creamy Protein 80 Cookies & Cream	500g	1	€ 23,99
SP917	Creamy Protein 80 Exquisite Chocolate	500g	1	€ 23,99

### Durchschnittliche Aminosäuregehalt\*

Alanin	3,77 g	1,13 g
Arginin	3,07 g	0,92 g
Asparaginsäure	8,52 g	2,55 g
Cystein**	1,21 g	0,36 g
Glutaminsäure	18,97 g	5,69 g
Glycin	1,83 g	0,54 g
Histidin**	2,37 g	0,71 g
Isoleucin**	5,55 g	1,66 g
Leucin**	9,49 g	2,84 g
Lysin**	8,22 g	2,46 g
Methionin**	2,36 g	0,70 g
Phenylalanin**	4,19 g	1,25 g
Prolin	8,50 g	2,55 g
Serin	5,24 g	1,57 g
Threonin**	5,07 g	1,52 g
Tryptophan**	1,48 g	0,44 g
Tyrosin**	4,25 g	1,27 g
Valin**	5,95 g	1,78 g

\* In Bezug auf den Proteingehalt  
 \*\*Essentielle Aminosäuren (halb essentielle Cystein und Tyrosin)

### Durchschnittliche Nährwerte

	pro 100 g Pulver	pro 30 g in 300 ml Wasser
Brennwert	1579kJ/372Kcal	474kJ/111kcal
Fett	3,2 g	0,96 g
davon gesättigten Fettsäuren	2,50 g	0,75 g
Kohlenhydrate	7,90 g	2,37 g
davon Zucker	7,00 g	2,1 g
Ballaststoffe	--	--
Eiweiß	78 g	23,4 g
Salz	0,60 g	0,18 g
Insgesamt BCAA	16,4 g	4,9 g

PUREST 90% PROTEIN FORMULA

CARBERY® ISOLAC 90

100% TOTAL CFM\*

FAT & CARB REDUCED



**Federica Pellegrini.**  
Olympiasiegerin. Weltrekordhalterin  
im 200m Freistil

NO  
AFTERTASTE

WORLD\*1  
HIGHEST  
PURITY



## Omega 3 Double Plus ++

Omega 3 Double Plus bietet die höchste Konzentration von EPA und DHA für e Kapseln und stellt diese dar die fortschrittlichste Innovation in Forschung und Produktionstechnologie. Die IFOS 5 Stelle Zertifizierung garantiert höchste Reinheit und des Rohmaterials, frei von Schwermetallen, Dioxinen und Schadstoffen, während die Informed Sport Quality Certification das Fehlen von mehr als 146 Dopingmitteln, Maskierung und Anabolika, für einen vollständigen Verbraucherschutz bescheinigt.

- > **Hohe Konzentration von Omega 3 für maximale Effizienz und bessere Compliance**
- > **559mg EPA und 229mg DHA pro Kapsel**
- > **Destilliertes und reines Fischöl**
- > **Vollständiges Fehlen von Fischnachgeschmack**

GLUTEN FREE LACTOSE FREE NO ADDED SUGAR HIGH CONCENTRATION INNOVATIVE FORMULA



### Durchschnittlicher Gehalt

	1 soft gel	4 soft gels
Fischöl	1000 mg	4000 mg
davon		
EPA	559 mg	2234 mg
DHA	229 mg	916 mg
Gesamt Omega 3	819 mg	3276 mg

BEFORE DURING AFTER



### Durchschnittlicher Gehalt

	Pro 2 Kps. (max. Tagesdosis)	% NRV*
Magnesium	120,0 mg	32
L-Taurin	76,0 mg	--
Vitamin E	30,0 mg	250
L-Glutamin	50,0 mg	--
Zink	9,0 mg	90
Vitamin B6	3,0 mg	214
Thiamin	2,1 mg	190
Mangan	5,0 mg	250
Pantothensäure	6,0 mg	100
Kupfer	1,2 mg	120
Chrom	50,0 mcg	125

## AR-Fit Formula + L-TAURINE + L-GLUTAMINE

Multivitamin- und Multimineralpräparat auf der Basis von Vitamin C, E, B1, B6, Pantothensäure, L-Glutamin, L-Taurin, Magnesium, Mangan, Chrom, Kupfer und Zink, mit Pflanzenextrakten aus Bockshornklee, grünem Tee und sibirischem Ginseng.

- > **Vitamin B6 und Magnesium tragen zur Reduzierung von Müdigkeit und Erschöpfung bei**
- > **Vitamin C und Kupfer tragen zum Schutz der Zellen vor oxidativem Stress bei**
- > **Grüntee-Extrakt ist für seineantioxidativen Eigenschaften bekannt**
- > **Angereichert mit L-Taurin**

WITH VITAMINS WITH MINERALS WITH PLANT EXTRACTS HIGH CONCENTRATION FAST ACTION

code	description	content	box	price
V107N	AR-Fit Formula	60cpr	1	€ 16,99

### Pflanzliche Inhaltsstoffe

	Pro 2 Kps. (max. Tagesdosis)	% NRV* Pro dosis
Hagebutte TE.	136,6 mg	--
Vitamin C- Gehalt	90 mg	112,5
Bockshornklee	100 mg	--
Grüner Tee	100 mg	--
Polyphenolgehalt	40 mg	--
Koffeingehalt	12 mg	--
Taigawurzel TE.	100 mg	--
Eleuteriosidegehalt	0,8 mg	--

VITAMIN  
C

VITAMIN  
B6

FAST  
ENERGY

**Vincenzo Nibali**  
 Bahrain-Merida Pro Cycling Team  
 Sieger des Giro d'Italia 2016  
 Sieger der Tour de France 2014  
 Sieger des Giro d'Italia 2013  
 Sieger der Vuelta a España 2010

>  
**Mineralsalze**

100%  
 Batch tested:  
**INFORMED-SPORT**  
 Trusted by sport

BEFORE DURING AFTER

WITH  
 TRIMAGNESIUM  
 CITRATE

WITH DIBASIC  
 POTASSIUM  
 PHOSPHATE

FAST  
 ENERGY



+ MAGNÉSIUM + POTASSIUM

Durchschnittlicher Gehalt	Pro 100 g	pro max.Tage- sdosis (60 g)	% NRV* Pro dosis
Natrium	1,18 g	0,71 g	--
Chlorid	746,00 mg	447,60 mg	56/93,25
Calcium	441,90 mg	265,14 mg	33,14/55,24
Kalium	500,00 mg	300,00 mg	15/25
Magnesium	241,40 mg	144,84 mg	38,62/64,37
Vitamin C	400,00 mg	240,00 mg	300/300
Thiamin	3,3 mg	1,98 mg	180/300
Riboflavin	4,2 mg	2,52 mg	180/300
Niacin	48,00 mg	28,8 mg	180/300
Vitamin B6	4,2 mg	2,52 mg	180/300
Folsäure	600 mcg	360 mcg	180/300
Vitamin B12	7,5 mcg	4,5 mcg	180/300
Biotin	150 mcg	90 mcg	180/300
Pantothensäure	18 mg	10,80 mg	180/300

\* NRV: Nutrient Reference Values (empfohlene Tagesdosis laut Verordnung ( EU ) Nr. 1169/2011)

## HydraFit

Mix aus Kohlenhydraten, Mineralsalzen und 9 Vitaminen für die Zubereitung einer hypotonischen Elektrolytlösung (Osmolarität 190 mOsm/l), um durch starkes Schwitzen bei intensiver körperlicher Aktivität bedingte Mineralstoffverluste auszugleichen. Die Stärken von HydraFit>

- > Erfrischender, durstlöschender Geschmack
- > Wirksame Flüssigkeitszufuhr
- > Magnesium und Kalium unterstützen die normale Muskelfunktion
- > Vitamin C und Magnesium tragen zur Reduzierung von Müdigkeit und Erschöpfung bei
- > Vitamin C und B6 unterstützen den Energiestoffwechsel

WITH VITAMINS WITH MINERALS GLUTEN FREE  
 ASPARTAME FREE ACESULFAME FREE LACTOSE FREE

code	description	content	box	price
SP500_1	HydraFit	400g	1	€ 6,99

### Durchschnittliche Nährwerte

	Pro 100 g	pro max.Tage- sdosis (60 g)	% NRV* Pro dosis
<b>Brennwert</b>	<b>1312,4 kJ/ 308,8 kcal</b>	<b>787,44 kJ/ 185,28 kcal</b>	--
<b>Fett</b>	<b>0 g</b>	<b>0 g</b>	--
davon gesättigte Fettsäuren	0 g	0 g	--
<b>Kohlenhydrate</b>	<b>77,20 g</b>	<b>46,32 g</b>	--
davon Zucker	53,45 g	32,07 g	--
<b>Ballaststoffe</b>	<b>0 g</b>	<b>0 g</b>	--
<b>Eiweiß</b>	<b>0 g</b>	<b>0 g</b>	--
<b>Salz</b>	<b>2,95 mg</b>	<b>1,77 mg</b>	--



**Power inside!**



Power inside!



FAST ENERGY



- VITAMIN C
- VITAMIN B6
- FAST ENERGY



Durchschnittliche Nährwerte

	Pro 100 g	Pro 30 g (max. Tagesdosis)	% NRV*
Brennwert	1270,2 kJ	381 kJ	--
	299 kcal	89,7 kcal	--
Fett	0,0 g	0,0 g	--
Kohlenhydrate	74,7 g	22,41 g	--
davon Zucker	53,30 g	15,99 g	--
Eiweiß	0,0 g	0,0 g	--
Salz	2,0 g	0,6 g	--

## Isonam Energy



Isotonische Formel (314,24 mOsm/l) auf der Basis von Maltodextrin, Mineralstoffen und Vitaminen, angereichert mit Creatin und Ginseng. Magnesium und Kalium unterstützen die physiologische Muskelfunktion. Ginseng ist ein Tonikum und bei körperlicher und geistiger Ermüdung ratsam. Creatin erhöht die körperliche Leistung bei Ausdauersport und bei kurzzeitiger, sehr intensiver Belastung. Isonam Energy ist bei intensiver sportlicher Aktivität aus folgenden Gründen nützlich:

- > Gleicht Mineralstoffverluste aufgrund von starkem Schwitzen aus
- > Vitamin C und B6 unterstützenden Energiestoffwechsel und tragen zur Reduzierung von Müdigkeit und Erschöpfung bei
- > Magnesium unterstützt die normale Muskelfunktion
- > Angereichert mit 3g Creatin und 30mg Ginseng

WITH VITAMINS WITH MINERALS FAST ACTION INSTANTLY SOLUBLE  
 ASPARTAME FREE ACESULFAME FREE GLUTEN FREE

code	description	content	box	price
SP13	ISONAM ENERGY Orange	480g	1	€ 16,99
SP12	ISONAM ENERGY Lemon	480g	1	€ 16,99

Durchschnittlicher Gehalt

Natrium	86,67 mg	248 mg	--
Chlorid	283,34 mg (35,42% VNR)	85 mg	10,62
Kalium	486,67 mg (24,34% VNR)	146 mg	7,3
Magnesium	200 mg (53,34% VNR)	60 mg	16
Vitamin B6	4,70 mg (335,7% VNR)	1,4 mg	100
Vitamin C	266,67 mg (333% VNR)	80 mg	100
Kreatin	10 g	3 g	--
Ginseng Trockenextr.	100 mg	30 mg	--

\* NRV: Nutrient Reference Values (empfohlene Tagesdosis laut Verordnung (EU) Nr. 1169/2011)

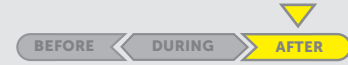

- VITAMIN C
- RECOVERY & HYDRATION



- + MAGNÉSIUM + POTASSIUM
- + CRÉATINE + GLUTAMINE

Durchschnittlicher Gehalt pro 2 Beutel (max. Tagesdosis) % NRV\*\*

Magnesium	400 mg	106,7
Kalium	500 mg	25
Kreatin	3000 mg	--
Glutamin*	1000 mg	--

\* Aminosäuren KyowaQuality®  
 \*\* NRV: Nutrient Reference Values (empfohlene Tagesdosis laut Verordnung (EU) Nr. 1169/2011). Reg.-Nr 54889.

## 4Fuel

4Fuel> ist ein innovatives Supplement auf der Basis von Kalium, Magnesium, Creatin und Glutamin. Eine ideale Formel für eine angemessene Mineralstoffzufuhr nach dem Training. Bestens geeignet bei Müdigkeit, Muskelschwäche, Krämpfen und starkem Schwitzen.

- > Fördert die Muskelfunktion
- > Hilft, Müdigkeit und Erschöpfung zu reduzieren
- > Unterstützt die Regenerationsphase
- > Angereichert mit 3g Creatin und 1g Glutamin KyowaQuality®

ASPARTAME FREE ACESULFAME FREE WITH AMINOACIDS GLUTEN FREE  
 FAST ABSORPTION WITH MINERALS NO SUGAR ADDED INSTANTLY SOLUBLE

code	description	content	box	price
SP21	4FUEL	20 sachet	1	€ 16,99

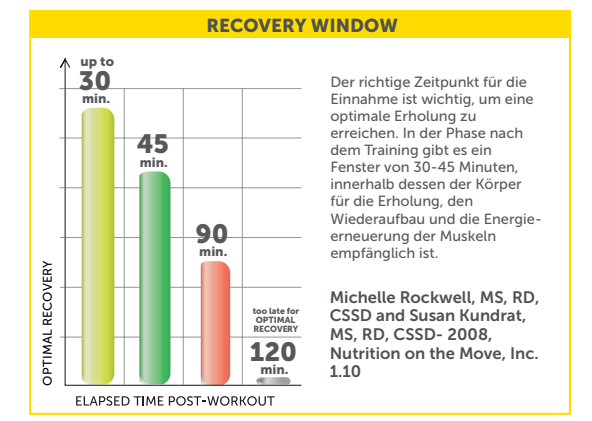

BEFORE DURING AFTER



## Acetyl L-Carnitine

Acetyl L-Carnitine ist ein wertvolles Energie-Supplement auf der Basis von 100 Prozent reinem Acetyl-L-Carnitin hoher Qualität, das bei aerobem oder hoch intensivem Training empfohlen wird.

- > **Höchste Reinheit**
- > **Schnelle Aufnahme**
- > **Spezielle Formel in Tabletten mit hoher Konzentration (1 g/Tablette)**

LACTOSE FREE GLUTEN FREE INSTANTLY SOLUBLE

code	description	content	box	price
SP332	ACETYL L-CARNITINE	60 cpr	1	€ 27,99

### Durchschnittlicher Gehalt

Pro 2 Kps. (max. Tagesdosis)

Acetyl - L - Carnitinhydrochlorid	1000 mg
-----------------------------------	---------

BEFORE DURING AFTER



## Maltonam

Maltonam ist ein wirksames Energie-Supplement für Sportler auf der Basis von einfachen und komplexen Kohlenhydraten mit unterschiedlicher Aufnahmegeschwindigkeit. Seine spezielle Formel ist mit Carnitin Carnipure®, L-Phenylalanin, Vitamin C und Vitaminen der B-Gruppe angereichert. Vor allem Vitamin C und die Vitamine der B-Gruppe tragen zu einem normalen Energiestoffwechsel bei.

- > **Liefert einen Mix aus Kohlenhydraten mit unterschiedlich schneller Freisetzung**
- > **Vitamin C trägt zum Schutz der Zellen vor oxidativem Stress bei**
- > **Vitamin B6 trägt zur Reduzierung von Müdigkeit und Erschöpfung bei**
- > **Mit Carnitin Hydrochlorid und Carnitintartrat Carnipure®**
- > **50% Maltodextrines Äquivalente en dextrose 10**

WITH VITAMINS GLUTEN FREE INSTANTLY SOLUBLE  
LACTOSE FREE WITH AMINO ACIDS

code	description	content	box	price
SP82	MALTONAM	500g	1	€ 15,99

### Durchschnittliche Nährwerte

Pro 100 g pro max. Tagesdosis (50 g) % NRV\*

<b>Brennwert</b>	<b>1574,2 kJ</b>	<b>787,1 kJ</b>	--
	<b>370,4 kcal</b>	<b>185,2 kcal</b>	--
<b>Fett</b>	<b>0 g</b>	<b>0 g</b>	--
<b>Kohlenhydrate</b>	<b>92,6 g</b>	<b>46,3 g</b>	--
davon Zucker	32,6 g	16,3 g	--
<b>Eiweiß</b>	<b>0 g</b>	<b>0 g</b>	--
<b>Salz</b>	<b>0,02 g</b>	<b>0,01 g</b>	--

### Durchschnittlicher Gehalt

Carnitin	1 g	500 mg	--
L-Phenylalanin	800 mg	400 mg	--
Riboflavin	0,84 mg (60% VNR)	0,42 mg	30
Thiamin	0,66 mg (60% VNR)	0,33 mg	30
Vitamin B6	0,84 mg (60% VNR)	0,42 mg	30
Vitamin C	1 g (1250% VNR)	500 mg	652

\* NRV: Nutrient Reference Values (empfohlene Tagesdosis laut Verordnung (EU) Nr. 1169/2011)

BEFORE DURING AFTER



EXTRA STRONG

HIGH CAFFEINE CONTENT

### Durchschnittliche Nährwerte

Pro max. Tagesdosis (1 Fläschchen)

<b>Brennwert</b>	<b>206 KJ/48,6 Kcal</b>
<b>Fett</b>	<b>0 g</b>
davon gesättigte Fettsäuren	0 g
<b>Kohlenhydrate</b>	<b>12 g</b>
davon Zucker	12 g
<b>Ballaststoffe</b>	<b>0 g</b>
<b>Eiweiß</b>	<b>0 g</b>
<b>Salz</b>	<b>0,037 g</b>

BEFORE DURING AFTER



FAST ENERGY

HIGH IN CAFFEINE

EXTRA STRONG

### Durchschnittlicher Gehalt

Pro 1 Tablette (max. Tagesdosis)

% NRV\*

Taurin	500 mg	--
Wasserfreies Koffein	120 mg	--
Gynostemma TE.	100 mg	--
Anteil an Gypenosiden	80 mg	--
Guarana TE.	100 mg	--
Anteil an Koffein	10 mg	--
Niacin	16 mg	100

\* NRV: Nutrient Reference Values (empfohlene Tagesdosis laut Verordnung (EU) Nr. 1169/2011)

## Total Energy Shot

Energie-Shot auf der Basis von Koffein, Guarana und Taurin, angereichert mit Holunderextrakt und Vitamin C und B12.

- > **Anregende, stimulierende Wirkung der Inhaltsstoffe**
- > **Ideal bei Ausdauersport und in der Phase des Endspurts**
- > **Vitamin B12 trägt zur Reduzierung von Müdigkeit und Erschöpfung bei**
- > **Vitamin C unterstützt einen normalen Energiestoffwechsel**
- > **Mit Guarana zur Aufrechterhaltung des Energiepegels**
- > **Angereichert mit Taurin und Koffein**

INSTANT ACTION GLUTEN FREE LACTOSE FREE  
NO SUGAR ADDED HIGH CONCENTRATION

code	description	content	box	price
SP151	TOTAL ENERGY SHOT Orange	60ml	50	€ 2,70

### Durchschnittlicher Gehalt

Vitamin C	180 mg (225%*)
Niacin	36 mg (225%*)
Vitamin B12	2,5 mcg (100%*)
Magnesium	225 mg (60%*)
Koffein	130 mg
Taurin	1000 mg
Guaran TE.	100 mg
Anteil an Koffein	50 mg
Schwarzer Holunder TE.	120 mg
Anteil an Polyphenolen	14,4 mg
Anteil an Antocyanen	10,4 mg

\* NRV: Nutrient Reference Values (empfohlene Tagesdosis laut Verordnung (EU) Nr. 1169/2011)

## Total Energy Rush

Tabletten mit hoher Konzentration an Taurin, Koffein und Niacin, angereichert mit Pflanzenextrakten aus Guarana und Unsterblichkeitskraut. Niacin fördert den Energiestoffwechsel, Guarana ist ein Tonikum und wirkt Müdigkeit und Erschöpfung entgegen. Unsterblichkeitskraut-Extrakt trägt zur Anregung des Kohlenhydrat- und Lipidstoffwechsels bei.

- > **Ideal bei Ausdauersport und bei hoch intensiver sportlicher Aktivität**
- > **Wirksam vor dem Training**
- > **Mit ausgewählten Pflanzenextrakten aus Guarana und Unsterblichkeitskraut**
- > **Vitamine der B-Gruppe unterstützen körperliche und geistige Funktionen und den Energiestoffwechsel**
- > **Angereichert mit Taurin und Koffein**

FAST ABSORPTION GLUTEN FREE LACTOSE FREE

code	description	content	box	price
SP830	TOTAL ENERGY RUSH	60 cpr	1	€ 16,99



# Gels



**Fabio Aru.**  
Italienischer Meister in Radfahren 2017.  
Gewinner des Vuelta a España 2015.

- FAST ENERGY
- PRO ENDURANCE



## Total Energy Carbo Gel

Energie-Gel auf der Basis von Maltodextrinen mit unterschiedlicher Aufnahmegeschwindigkeit (DE-Wert: 9,19), Dextrose und Fructose, angereichert mit Mineralsalzen.

- > Maltodextrine mit unterschiedlich schneller Freisetzung (DE-Wert: 9,19)
- > Besonders nützlich bei Ausdauersport
- > Ideal vor und während des Trainings
- > Für schnelle Energiezufuhr
- > Formulation enrichie en taurine et caféine

FAST ABSORPTION | TIME RELEASED  
NATURAL FLAVOURS | VEGAN FRIENDLY  
GLUTEN FREE | GREAT TASTE

code	description	content	box	price
SP8381	TOTAL ENERGY CARBO GEL Agrumix	40ml	24	€ 2,00

Durchschnittliche Nährwerte

	Pro 100 ml	pro 2 Packungen täg. (80 ml)
Brennwert	1294 kJ/ 304 kcal	1035 kJ/244 kcal
Fett	0 g	0 g
davon gesättigte Fettsäuren	0 g	0 g
Kohlenhydrate	76 g	61 g
davon Zucker	33 g	27 g
Ballaststoffe	0 g	0 g
Eiweiß	0 g	0 g
Salz	0,34 g	0,27 g



## Total Energy Fruit Jelly

Schmackhaftes Energie-Gelee auf der Basis von Kohlenhydraten und echter Frucht, angereichert mit Mineralsalzen. Ideal als Snack vor und während des Trainings.

- > Mit echter Frucht (72%)
- > Kohlenhydrate mit unterschiedlicher Aufnahmegeschwindigkeit
- > Magnesium unterstützt die normale Muskelfunktion
- > Enthält kein Fett

FAST ACTION | WITH MINERALS | GLUTEN FREE  
FAT FREE | VEGAN FRIENDLY

code	description	content	box	price
SP112	Total Energy Fruit Jelly Peach Orange & Lemon	42g	28	€ 2,00

Durchschnittlicher Gehalt

	Pro 100 g	pro 2 Packungen täg. (80 ml)
Kalium	2,3 mg	1,9 mg
Magnesium	67,1 mg	56,4 mg (15% NRV*)

\* NRV: Nutrient Reference Values (empfohlene Tagesdosis laut Verordnung (EU) Nr. 1169/2011)

Durchschnittliche Nährwerte

	Pro 100 g	pro 2 Packungen täg. (80 ml)
Brennwert	730 kJ/ 172 kcal	613 kJ/ 144 kcal
Fett	0 g	0 g
davon gesättigte Fettsäuren	0 g	0 g
Kohlenhydrate	41 g	35 g
davon Zucker	41 g	35 g
Ballaststoffe	2,3 g	1,9 g
Eiweiß	0,50 g	41 g
Salz	>0,01 g	<0,01 g

- FAST ENERGY
- PRO ENDURANCE



## Total Energy Strong Gel

Energie-Gel auf der Basis von Maltodextrinen mit unterschiedlicher Aufnahmegeschwindigkeit (DE-Wert: 9,19), angereichert mit Koffein, Taurin und Guarana.

- > Wirksamer Energiespender
- > Maltodextrine mit unterschiedlichem DE-Wert
- > Für schnelle Energiezufuhr
- > Ideal während des Trainings
- > Stimulierend beim Sprint und Endspurt

FAST ENERGY | GREAT TASTE | TIME RELEASED | VEGAN FRIENDLY  
WITH CAFFEINE | WITH PLANT EXTRACTS | GLUTEN FREE

code	description	content	box	price
SP8391	TOTAL ENERGY STRONG GEL Lemon	40ml	24	€ 2,00

Durchschnittliche Nährwerte

	pro 100 ml	pro 1 Beutel täg. (= 40 ml)
Brennwert	1267 kJ/ 298 kcal	507 kJ/119 kcal
Fett	0 g	0 g
davon gesättigte Fettsäuren	0 g	0 g
Kohlenhydrate	74 g	30 g
davon Zucker	31 g	13 g
Ballaststoffe	0 g	0 g
Eiweiß	0 g	0 g
Salz	0,34 g	0,14 g

Durchschnittlicher Gehalt

	pro 1 Beutel täg. (= 40 ml)
L-Taurin	400 mg
Guarana TE, titr. 10% Koffein	154 mg
davon Koffein	15,4 mg
Koffein	50 mg

BEFORE DURING AFTER



## Total Energy Hydra Gel

Energie-Gel auf der Basis von Maltodextrinen mit unterschiedlich schneller Freisetzung, Palatinose™ (mit niedrigem glykämischen Index) und Vitargo®, angereichert mit Mineralsalzen, um dem Sportler ständig und schrittweise Energie zuzuführen. Mit Vitamin C, um bei Ausdauersport Müdigkeit und Erschöpfung entgegenzuwirken.

- > Mit Isomaltulose Palatinose™ mit niedrigem glykämischen Index
- > Mit Mineralsalzen und Kohlenhydraten mit unterschiedlicher Aufnahmegeschwindigkeit
- > Mit Vitamin C, um die Eisenaufnahme zu erleichtern und den Energiestoffwechsel anzuregen
- > Magnesium, Calcium und Kalium unterstützen die Muskelfunktion
- > Ideal vor und während des Trainings

WITH MINERALS WITH VITAMIN C VEGAN FRIENDLY  
GLUTEN FREE GREAT TASTE

code	description	content	box	price
SP9371	TOTAL ENERGY HYDRA GEL Lemon & Peach	50ml	32	€ 2,20

Durchschnittlicher Gehalt		% NRV*
pro Tagesdosis. (2x50 ml)		
Kalium	300 mg	15
Calcium	120 mg	15
Magnesium	56,3 mg	15
Eisen	2,1 mg	15
Vitamin C	120 mg	150

\* NRV: Nutrient Reference Values (empfohlene Tagesdosis laut Verordnung (EU) Nr. 1169/2011)

### Durchschnittliche Nährwerte

	Pro 100 ml	pro Tagesdosis. (2x50 ml)
<b>Brennwert</b>	<b>900 kJ/ 212 kcal</b>	<b>900 kJ/ 212 kcal</b>
<b>Fett</b>	-	-
davon gesättigte Fettsäuren	-	-
<b>Kohlenhydrate</b>	-	-
davon Zucker	28 g	28 g
<b>Ballaststoffe</b>	-	-
<b>Eiweiß</b>	-	-
<b>Salz</b>	-	-

BEFORE DURING AFTER



## Total Energy Amino Gel

Energie-Gel auf der Basis von Maltodextrinen mit unterschiedlich schneller Freisetzung, Fructose, Vitargo® und Isomaltulose Palatinose™ (mit niedrigem glykämischen Index) für eine ausgewogene, lang anhaltende Energiezufuhr in Form von Glucose. Seine spezielle Formel ist mit verzweigtkettigen Aminosäuren Ajipure® angereichert. Die glucogenen Aminosäuren Alanin und Glycin liefern Energie und sind an der Glucosesynthese beteiligt.

- > Mit Isomaltulose Palatinose™ mit niedrigem glykämischen Index
- > Führt ständig und stufenweise Energie zu
- > Unterstützt Ausdauerleistung
- > Mit Aminosäuren Ajipure®
- > Ideal bei Ausdauersport vor und während des Trainings

WITH AMINO ACIDS GLUTEN FREE  
WITH BCAA VEGAN FRIENDLY GREAT TASTE

code	description	content	box	price
SP9361	TOTAL ENERGY AMINO GEL Orange Flavour	50ml	32	€ 2,20

Durchschnittlicher Gehalt		%NVR*
pro Tagesdosis. (2x50ml)		
L-Leucin	620 mg	
L-Isoleucin	310 mg	
L-Valin	310 mg	
β-Alanin	300 mg	

\* NRV: Nutrient Reference Values (empfohlene Tagesdosis laut Verordnung (EU) Nr. 1169/2011)

### Durchschnittliche Nährwerte

	Pro 100 ml	pro Tagesdosis. (2x50 ml)
<b>Brennwert</b>	<b>862 kJ/ 203 kcal</b>	<b>862 kJ/ 203 kcal</b>
<b>Fett</b>	-	-
davon gesättigte Fettsäuren	-	-
<b>Kohlenhydrate</b>	<b>49 g</b>	<b>49 g</b>
davon Zucker	32 g	32 g
<b>Ballaststoffe</b>	<b>&lt;0,5 g</b>	<b>&lt;0,5 g</b>
<b>Eiweiß</b>	-	-
<b>Salz</b>	-	-

BEFORE DURING AFTER



FAST ENERGY

PRO ENDURANCE

## Sport Gel



Energie-Gels auf der Basis von einfachen und komplexen Kohlenhydraten mit unterschiedlich schneller Freisetzung, mit D-Ribose und Isomaltulose Palatinose™ (mit niedrigem glykämischen Index) für eine ständige, schrittweise Energiezufuhr. Erhältlich in vier erfrischenden Geschmacksrichtungen. Zusatz von spezifischen Inhaltsstoffen, um den Körper in jeder Trainingsphase zu unterstützen.

- > Mit Isomaltulose Palatinose™ mit niedrigem glykämischen Index
- > Maltodextrine mit unterschiedlichem DE-Wert
- > Für sofortige und lang anhaltende Energiezufuhr
- > Besonders nützlich bei Ausdauersport
- > Ideal vor und während des Trainings
- > Enthält kein Fett

GLUTEN FREE NO FAT GREAT TASTE  
TIME RELEASED VEGAN FRIENDLY

code	description	content	box	price
SP9402	SPORT GEL Cola Lime	25ml	15	€ 1,60
SP9391	SPORT GEL Lemon Ice Tea	25ml	15	€ 1,60
SP9381	SPORT GEL Orange	25ml	15	€ 1,60
SP9401	SPORT GEL Tropical	25ml	15	€ 1,60

### > Glucogenic Formula – Geschmacksrichtung Lemon Ice Tea

Mit glucogenen Aminosäuren Glycin und L-Alanin reiner Qualität Ajipure®, die an der Glucosesynthese beteiligt sind und Energie liefern.

>> 5 CARB MATRIX >> WITH L-ALANINE >> WITH GLYCINE

Durchschnittliche Nährwerte	Pro 100 ml	pro Tagesdosis (25 ml)
<b>Brennwert</b>	<b>1190 kJ/ 280 kcal</b>	<b>297 kJ/ 70 kcal</b>
<b>Fett</b>	<b>0 g</b>	<b>0 g</b>
davon gesättigten Fettsäuren	0 g	0 g
<b>Kohlenhydrate</b>	<b>70 g</b>	<b>17 g</b>
davon Zucker	45 g	11 g
<b>Ballaststoffe</b>	<b>0 g</b>	<b>0 g</b>
<b>Eiweiss</b>	<b>0 g</b>	<b>0 g</b>
<b>Salz</b>	<b>0,26 g</b>	<b>0,07 g</b>

Durchschnittlicher Inhalt: Pro 100 ml / 25 ml (Tagesdosis)  
Glycin: 2,0 g / 0,5 g, L-Alanin: 2,0 g / 0,5 g.  
\* Gleich 0, weil es nur freie Aminosäuren gibt.

### > Hydration Formula – Geschmacksrichtung Tropical

Mit Zusatz von Magnesium und Kalium, um die Muskelfunktion während des Trainings zu

>> WITH MAGNESIUM >> WITH POTASSIUM >> 5 CARB MATRIX

Durchschnittliche Nährwerte	Pro 100 ml	pro Tagesdosis (25 ml)
<b>Brennwert</b>	<b>1180 kJ/ 278 kcal</b>	<b>295 kJ/ 69 kcal</b>
<b>Fett</b>	<b>0 g</b>	<b>0 g</b>
davon gesättigten Fettsäuren	0 g	0 g
<b>Kohlenhydrate</b>	<b>68,9 g</b>	<b>17,2 g</b>
davon Zucker	44,7 g	11,2 g
<b>Ballaststoffe</b>	<b>0 g</b>	<b>0 g</b>
<b>Eiweiss</b>	<b>0 g</b>	<b>0 g</b>
<b>Salz</b>	<b>0,26 g</b>	<b>0,06 g</b>
<b>Kalium</b>	<b>1200 mg</b>	<b>300 mg</b>
(60% VNR**)		(15% VNR**)
<b>Magnesium</b>	<b>225 mg</b>	<b>56,25 mg</b>
(60% VNR**)		(15% VNR**)

\*\*VNR: tägliche Referenzwerte für die Ernährung (Erwachsene) gemäß EU-Verordnung 1169/2011.

>> 5 CARB MATRIX >> WITH CAFFEINE >> DOUBLE POWER

Durchschnittliche Nährwerte	Pro 100 ml	pro Tagesdosis (25 ml)
<b>Brennwert</b>	<b>1177 kJ/ 277 kcal</b>	<b>294 kJ/ 69 kcal</b>
<b>Fett</b>	<b>0 g</b>	<b>0 g</b>
davon gesättigten Fettsäuren	0 g	0 g
<b>Kohlenhydrate</b>	<b>68,9 g</b>	<b>17,2 g</b>
davon Zucker	44,7 g	11,2 g
<b>Ballaststoffe</b>	<b>0 g</b>	<b>0 g</b>
<b>Eiweiss</b>	<b>0 g</b>	<b>0 g</b>
<b>Salz</b>	<b>0,27 g</b>	<b>0,07 g</b>

Durchschnittlicher Inhalt: Pro 100 ml / 25 ml (Tagesdosis)  
Koffein: 200 mg / 50 mg.

### > Pure Energy Formula – Geschmacksrichtung Orange

Mit 5 Kohlenhydraten mit unterschiedlicher Absorptionsgeschwindigkeit, um dem Sportler ständig und schrittweise Energie zuzuführen.

>> ISOTONIC ENERGY >> 5 CARB MATRIX >> NO CAFFEINE

Durchschnittliche Nährwerte	Pro 100 ml	pro Tagesdosis (25 ml)
<b>Brennwert</b>	<b>1184 kJ/ 278 kcal</b>	<b>396 kJ/ 70 kcal</b>
<b>Fett</b>	<b>0 g</b>	<b>0 g</b>
davon gesättigten Fettsäuren	0 g	0 g
<b>Kohlenhydrate</b>	<b>68,9 g</b>	<b>17,2 g</b>
davon Zucker	44,7 g	11,2 g
<b>Ballaststoffe</b>	<b>0 g</b>	<b>0 g</b>
<b>Eiweiss</b>	<b>0 g</b>	<b>0 g</b>
<b>Salz</b>	<b>0,26 g</b>	<b>0,06 g</b>



# Shots

280 mg

VITAMIN B6

FAST ENERGY

BEFORE DURING AFTER



### Durchschnittliche Nährwerte

	pro Tagesdosis (25 ml)	%NRV*
Vitamin B6	1,4 mg	100
Magnesium	280 mg	100

\* NRV: Nutrient Reference Values (empfohlene Tagesdosis laut Verordnung (EU) Nr. 1169/2011)

BEFORE DURING AFTER



### Durchschnittlicher Gehalt

	Pro empfohlene Tagesdosis (25 ml)	% NRV*
Magnesium	225 mg	60
Vitamin C	160 mg	200
Pantothensäure	1,8 mg	30
Vitamin B6	0,42 mg	30
Vitamin B1	0,33 mg	30
Guarana TE.	2000 mg	-
Koffeinanteil	200 mg	-

\* NRV: Nutrient Reference Values (empfohlene Tagesdosis laut Verordnung (EU) Nr. 1169/2011)

## Magnesium Liquid + Vitamin B6

Jedes Fläschchen Magnesium Liquid enthält 280 mg Magnesium und 1,4 mg Vitamin B6. Die Einnahme ist vor allem nach dem Training und in der Regenerationsphase angezeigt. Magnesium ist ein essentieller Mineralstoff, der für die Gesundheit des Körpers von großer Bedeutung ist: Er wirkt Müdigkeit und Erschöpfung entgegen, unterstützt die Muskelfunktion und ist an der Proteinbiosynthese sowie an der Funktion des Nervensystems beteiligt. Vitamin B6 trägt zum normalen Protein- und Glykogenstoffwechsel bei.

- > Flüssiges Magnesiumkonzentrat in Einzeldosis
- > 280mg Magnesium pro Trinkfläschchen
- > Angereichert mit Vitamin B6
- > Vermindert das Müdigkeitsgefühl
- > Unterstützt die Muskelleistung
- > Spielt eine wichtige Rolle in der Proteinsynthese

### FORMULE STRONG

- + MAGNÉSIUM
- + VITAMINE B6

- FAST ABSORPTION
- GLUTEN FREE
- WITH VITAMINS
- HIGH CONCENTRATION
- LACTOSE FREE
- WITH MINERALS

code	description	content	box	price
SP291	MAGNESIUM LIQUID + VITAMIN B6	25ml	20	€ 1,50

## Guarana Super Strong Liquid

Shot mit energiespendender Wirkung auf der Basis von Guarana, Magnesium und Vitaminen, nützlich vor allem bei Ausdauersport. Guarana ist ein Tonikum und wirkt energiespendend; Magnesium unterstützt die Muskelfunktion und die Proteinbiosynthese und wirkt Müdigkeit entgegen; Vitamin B6 trägt zur Reduzierung von Ermüdungserscheinungen bei, Vitamin C schützt die Zellen vor oxidativem Stress und Pantothensäure unterstützt die geistige Leistungsfähigkeit.

- > 2000mg Guarana-Extrakt pro Shot
- > Hohe Koffeinzufuhr: 200mg
- > Ideal vor dem Training oder in der Sprintphase
- > Angereichert mit Vitamin B1 und B6
- > Mit Vitamin C als Oxidationshemmer

- FAST ABSORPTION
- GLUTEN FREE
- WITH VITAMINS
- HIGH CONCENTRATION
- LACTOSE FREE
- WITH MINERALS
- WITH PLANT EXTRACTS
- WITH CAFFEINE

- + GUARANA
- + MAGNÉSIUM
- + VITAMINES

code	description	content	box	price
SP271	GUARANÀ SUPER STRONG LIQUID	fiala 20ml	20	€ 2,60

25  
M. VIÑALES



SPA



MOVISTAR YAMAHA  
MotoGP

46  
V. ROSSI



ITA



MOVISTAR YAMAHA  
MotoGP



OFFICIAL  
SUPPLIER  
MotoGP Team 2018





**Sales Manager / Verkaufsleiter:** Pietro Tomasella · p.tomasella@a4selection.com · Tel. +39 3405705661

For complaints and returns contact **info@a4selection.com** to receive the return authorization and all the related instructions.  
Bitte kontaktieren **info@a4selection.com**, um Informationen über Reklamationen und Rückabe zu erhalten.

**Crankbrothers Assistance Service / Service Crankbrothers Österreich:** PippoWheels srl  
Via S. Venier, 15 · 36100 Vicenza IT · Tel. +39 0444 532052 · service@pippowheels.com

**Copyright.** All contents of this catalog, including texts, documents, logos, images, graphics, videos, their own arrangement and adaptation within the site, are protected by the Copyright<sup>®</sup> laws of Selle Royal S.p.A. and other intellectual property rights. The reproduction, alteration, modification, publication and use, even partial, of this content for any purpose, whether commercial or not, in any format and support, are not permitted without the express written permission of Selle Royal S.p.A. All rights reserved.

**Brand names.** Brand names. All trademarks and logos in the catalog are the exclusive property of their respective owners. Any use and / or reproduction of the same for any purpose or means is expressly and strictly prohibited and will be prosecuted.

**Liability limits.** The contents and information in the catalog are provided "as is" and periodically updated and checked. Consequently, they may not be complete, accurate or updated at any time, or may contain errors. Selle Royal S.p.A. disclaims any liability and any warranty regarding the completeness, updating, errors and omissions of the information and content contained in the catalog.

---

**Copyright.** Sämtliche Inhalte in diesem Katalog, einschließlich Texte, Dokumente, Logos, Bilder, Grafiken, Videos, sowie deren Anordnung und deren Adaption innerhalb der Seite, unterliegen dem Urheberrecht der Selle Royal S.p.A und anderen Gesetzen zum Schutz geistigen Eigentums. Eine Vervielfältigung, Abänderung, Bearbeitung, Veröffentlichung, Verbreitung des Inhaltes, ganz oder teilweise, für kommerzielle oder anderweitige Verwendung ist ausdrücklich nur gestattet wenn eine schriftliche Erlaubnis der Selle Royal S.p.A. vorliegt. Alle Rechte vorbehalten.

**Markenzeichen.** Sämtliche gezeigte Markenzeichen und Logos innerhalb dieses Katalogs sind ausschließliches Eigentum ihrer jeweiligen Besitzer. Jegliche Benutzung und/oder eine Reproduktion dieser ist ausdrücklich und strengstens verboten und wird strafrechtlich verfolgt.

**Haftungshinweis.** Die Inhalte und Informationen, die in diesem Katalog zur Verfügung gestellt werden, gelten als gegeben und werden regelmäßig überprüft und überarbeitet. Folglich können diese unvollständig, bereits überarbeitet oder fehlerhaft sein. Selle Royal S.p.A. übernimmt keine Haftung oder Gewähr für Vollständigkeit, Aktualität, Fehler und Versäumnisse auf die bereitgestellten Inhalte und Informationen in diesem Katalog.



**C/O SELLE ROYAL SpA**

Via Vittorio Emanuele, 119 · 36050 Pozzoleone (VI) Italy  
Tel. +39 0444 461100 / +39 0444 461102 · Fax. +39 0444 462025  
info@a4selection.com · www.a4selection.com

The products in this catalog are covered by a 2 years guarantee from the purchase date.  
Die im Katalog anwesende Produkte sind eine 2 Jahre Garantie ab Kaufdatum abgeschert.

# SELECTION

